

FANUC Series 0 \dot{i} -MODEL C
FANUC Series 0 \dot{i} Mate-MODEL C

MAINTENANCE MANUAL

- No part of this manual may be reproduced in any form.
- All specifications and designs are subject to change without notice.

The products in this manual are controlled based on Japan's "Foreign Exchange and Foreign Trade Law". The export from Japan may be subject to an export license by the government of Japan.

Further, re-export to another country may be subject to the license of the government of the country from where the product is re-exported. Furthermore, the product may also be controlled by re-export regulations of the United States government.

Should you wish to export or re-export these products, please contact FANUC for advice.

In this manual we have tried as much as possible to describe all the various matters.

However, we cannot describe all the matters which must not be done, or which cannot be done, because there are so many possibilities.

Therefore, matters which are not especially described as possible in this manual should be regarded as "impossible".

SAFETY PRECAUTIONS

This section describes the safety precautions related to the use of CNC units. It is essential that these precautions be observed by users to ensure the safe operation of machines equipped with a CNC unit (all descriptions in this section assume this configuration).

CNC maintenance involves various dangers. CNC maintenance must be undertaken only by a qualified technician.

Users must also observe the safety precautions related to the machine, as described in the relevant manual supplied by the machine tool builder.

Before checking the operation of the machine, take time to become familiar with the manuals provided by the machine tool builder and FANUC.

Contents

| | |
|--|-----|
| 1. DEFINITION OF WARNING, CAUTION, AND NOTE | s-2 |
| 2. WARNINGS RELATED TO CHECK OPERATION | s-3 |
| 3. WARNINGS RELATED TO REPLACEMENT | s-5 |
| 4. WARNINGS RELATED TO PARAMETERS | s-6 |
| 5. WARNINGS AND NOTES RELATED TO DAILY MAINTENANCE | s-7 |

1

DEFINITION OF WARNING, CAUTION, AND NOTE

This manual includes safety precautions for protecting the maintenance personnel (herein referred to as the user) and preventing damage to the machine. Precautions are classified into Warnings and Cautions according to their bearing on safety. Also, supplementary information is described as a Note. Read the Warning, Caution, and Note thoroughly before attempting to use the machine.

WARNING

Applied when there is a danger of the user being injured or when there is a danger of both the user being injured and the equipment being damaged if the approved procedure is not observed.

CAUTION

Applied when there is a danger of the equipment being damaged, if the approved procedure is not observed.

NOTE

The Note is used to indicate supplementary information other than Warning and Caution.

- **Read this manual carefully, and store it in a safe place.**

2 WARNINGS RELATED TO CHECK OPERATION

WARNING

1. When checking the operation of the machine with the cover removed
 - (1) The user's clothing could become caught in the spindle or other components, thus presenting a danger of injury. When checking the operation, stand away from the machine to ensure that your clothing does not become tangled in the spindle or other components.
 - (2) When checking the operation, perform idle operation without workpiece. When a workpiece is mounted in the machine, a malfunction could cause the workpiece to be dropped or destroy the tool tip, possibly scattering fragments throughout the area. This presents a serious danger of injury. Therefore, stand in a safe location when checking the operation.
2. When checking the machine operation with the power magnetics cabinet door opened
 - (1) The power magnetics cabinet has a high-voltage section (carrying a  mark). Never touch the high-voltage section. The high-voltage section presents a severe risk of electric shock. Before starting any check of the operation, confirm that the cover is mounted on the high-voltage section. When the high-voltage section itself must be checked, note that touching a terminal presents a severe danger of electric shock.
 - (2) Within the power magnetics cabinet, internal units present potentially injurious corners and projections. Be careful when working inside the power magnetics cabinet.
3. Never attempt to machine a workpiece without first checking the operation of the machine. Before starting a production run, ensure that the machine is operating correctly by performing a trial run using, for example, the single block, feedrate override, or machine lock function or by operating the machine with neither a tool nor workpiece mounted. Failure to confirm the correct operation of the machine may result in the machine behaving unexpectedly, possibly causing damage to the workpiece and/or machine itself, or injury to the user.
4. Before operating the machine, thoroughly check the entered data. Operating the machine with incorrectly specified data may result in the machine behaving unexpectedly, possibly causing damage to the workpiece and/or machine itself, or injury to the user.

 **WARNING**

- 5.** Ensure that the specified feedrate is appropriate for the intended operation. Generally, for each machine, there is a maximum allowable feedrate. The appropriate feedrate varies with the intended operation. Refer to the manual provided with the machine to determine the maximum allowable feedrate. If a machine is run at other than the correct speed, it may behave unexpectedly, possibly causing damage to the workpiece and/or machine itself, or injury to the user.
- 6.** When using a tool compensation function, thoroughly check the direction and amount of compensation.
Operating the machine with incorrectly specified data may result in the machine behaving unexpectedly, possibly causing damage to the workpiece and/or machine itself, or injury to the user.

3

WARNINGS RELATED TO REPLACEMENT

WARNING

1. Always turn off the power to the CNC and the main power to the power magnetics cabinet. If only the power to the CNC is turned off, power may continue to be supplied to the serve section. In such a case, replacing a unit may damage the unit, while also presenting a danger of electric shock.
2. When a heavy unit is to be replaced, the task must be undertaken by two persons or more. If the replacement is attempted by only one person, the replacement unit could slip and fall, possibly causing injury.
3. After the power is turned off, the servo amplifier and spindle amplifier may retain voltages for a while, such that there is a danger of electric shock even while the amplifier is turned off. Allow at least twenty minutes after turning off the power for these residual voltages to dissipate.
4. When replacing a unit, ensure that the new unit has the same parameter and other settings as the old unit. (For details, refer to the manual provided with the machine.) Otherwise, unpredictable machine movement could damage the workpiece or the machine itself, and present a danger of injury.

4

WARNINGS RELATED TO PARAMETERS

WARNING

1. When machining a workpiece for the first time after modifying a parameter, close the machine cover. Never use the automatic operation function immediately after such a modification. Instead, confirm normal machine operation by using functions such as the single block function, feedrate override function, and machine lock function, or by operating the machine without mounting a tool and workpiece. If the machine is used before confirming that it operates normally, the machine may move unpredictably, possibly damaging the machine or workpiece, and presenting a risk of injury.
2. The CNC and PMC parameters are set to their optimal values, so that those parameters usually need not be modified. When a parameter must be modified for some reason, ensure that you fully understand the function of that parameter before attempting to modify it. If a parameter is set incorrectly, the machine may move unpredictably, possibly damaging the machine or workpiece, and presenting a risk of injury.

5

WARNINGS AND NOTES RELATED TO DAILY MAINTENANCE

WARNING

1. Memory backup battery replacement

When replacing the memory backup batteries, keep the power to the machine (CNC) turned on, and apply an emergency stop to the machine. Because this work is performed with the power on and the cabinet open, only those personnel who have received approved safety and maintenance training may perform this work.

When replacing the batteries, be careful not to touch the high-voltage circuits (marked  and fitted with an insulating cover).

Touching the uncovered high-voltage circuits presents an extremely dangerous electric shock hazard.

NOTE

The CNC uses batteries to preserve the contents of its memory, because it must retain data such as programs, offsets, and parameters even while external power is not applied.

If the battery voltage drops, a low battery voltage alarm is displayed on the machine operator's panel or CRT screen.

When a low battery voltage alarm is displayed, replace the batteries within a week. Otherwise, the contents of the CNC's memory will be lost.

To replace the battery, see the procedure described in Section 2.10 of this manual.



2. Absolute pulse coder battery replacement

When replacing the memory backup batteries, keep the power to the machine (CNC) turned on, and apply an emergency stop to the machine. Because this work is performed with the power on and the cabinet open, only those personnel who have received approved safety and maintenance training may perform this work.

When replacing the batteries, be careful not to touch the high-voltage circuits (marked  and fitted with an insulating cover).

Touching the uncovered high-voltage circuits presents an extremely dangerous electric shock hazard.

NOTE

The absolute pulse coder uses batteries to preserve its absolute position.

If the battery voltage drops, a low battery voltage alarm is displayed on the machine operator's panel or CRT screen.

When a low battery voltage alarm is displayed, replace the batteries within a week. Otherwise, the absolute position data held by the pulse coder will be lost.

To replace the battery, see the procedure described in Servo Amplifier Maintenance Manual.



3. Fuse replacement

Before replacing a blown fuse, however, it is necessary to locate and remove the cause of the blown fuse.

For this reason, only those personnel who have received approved safety and maintenance training may perform this work.

When replacing a fuse with the cabinet open, be careful not to touch the high-voltage circuits (marked  and fitted with an insulating cover).

Touching an uncovered high-voltage circuit presents an extremely dangerous electric shock hazard.

PREFACE



Description of this manual

1. Display and operation

This chapter covers those items, displayed on the screen, that are related to maintenance. A list of all supported operations is also provided at the end of this chapter.

2. Hardware

This chapter describes the configuration of the hardware, lists the hardware units, and explains how to replace printed-circuit boards.

3. Data input/output

This chapter describes the input/output of data, including programs, parameters, and tool compensation data, as well as the input/output procedures for conversational data.

4. Interface between the CNC and PMC

This chapter describes the PMC specifications, the system configuration, and the signals used by the PMC.

5. Digital servo

This chapter describes the servo tuning screen and how to adjust the reference position return position.

6. AC spindles

These chapters describe the spindle amplifier checkpoints, as well as the spindle tuning screen.

7. Trouble shooting

This chapter describes the procedures to be followed in the event of certain problems occurring.

Appendix

- A. Alarm list
- B. List of maintenance parts
- C. Boot system
- D. FSSB start-up procedure/materials
- E. Notation of MDI keys

This manual does not provide a parameter list. If necessary, refer to the separate PARAMETER MANUAL.

Applicable models

The models covered by this manual, and their abbreviations are:

| Product name | Abbreviation | |
|-------------------------|--------------|----------------|
| FANUC Series 0i-TC | 0i-TC | Series 0i |
| FANUC Series 0i-MC | 0i-MC | |
| FANUC Series 0i-PC | 0i-PC | |
| FANUC Series 0i Mate-TC | 0i-Mate TC | Series 0i Mate |
| FANUC Series 0i Mate-MC | 0i-Mate TC | |

NOTE

Some function described in this manual may not be applied to some products.
 For details, refer to the DESCRIPTIONS manual (B-64112EN)

There are two types of basic units for Series 0i-C and Series 0i Mate-C:

| Basic unit drawing No. | Model |
|---|--|
| A02B-0309-B50n(n=0,1,...,9) A02B-0311-B50n(n=0,1,...,9) A02B-0311-B51n(n=0,1,...,9) | Series 0i -C Series 0i Mate-C Series 0i Mate-C |
| A02B-0309-B52n(n=0,1,...,9) A02B-0311-B52n(n=0,1,...,9) A02B-0311-B53n(n=0,1,...,9) | Series 0i -C Series 0i Mate-C Series 0i Mate-C |

Related manuals of Series 0i-C/0i Mate-C

The following table lists the manuals related to Series 0i-C, Series 0i Mate-C.

This manual is indicated by an asterisk(*).

| Manual name | Specification number | |
|--|----------------------|---|
| FANUC Series 0i-MODEL C/0i Mate-MODEL C DESCRIPTIONS | B-64112EN | |
| FANUC Series 0i-MODEL C/0i Mate-MODEL C CONNECTION MANUAL (HARDWARE) | B-64113EN | |
| FANUC Series 0i-MODEL C/0i Mate-MODEL C CONNECTION MANUAL (FUNCTION) | B-64113EN-1 | |
| FANUC Series 0i-PC CONNECTION MANUAL (FUNCTION) | B-64153EN | |
| FANUC Series 0i-TC OPERATOR'S MANUAL | B-64114EN | |
| FANUC Series 0i-MC OPERATOR'S MANUAL | B-64124EN | |
| FANUC Series 0i Mate-TC OPERATOR'S MANUAL | B-64134EN | |
| FANUC Series 0i Mate-MC OPERATOR'S MANUAL | B-64144EN | |
| FANUC Series 0i-PC OPERATOR'S MANUAL | B-64154EN | |
| FANUC Series 0i-MODEL C/0i Mate-MODEL C MAINTENANCE MANUAL | B-64115EN | * |
| FANUC Series 0i-MODEL C/0i Mate-MODEL C PARAMETER MANUAL | B-64120EN | |
| FANUC Series 0i-PC PARAMETER MANUAL | B-64160EN | |
| PROGRAMMING MANUAL | | |
| Macro Compiler/Macro Executor PROGRAMMING MANUAL | B-61803E-1 | |
| FANUC MACRO COMPILER (For Personal Computer) PROGRAMMING MANUAL | B-66102E | |
| PMC | | |
| PMC Ladder Language PROGRAMMING MANUAL | B-61863E | |
| PMC C Language PROGRAMMING MANUA | B-61863E-1 | |
| Network | | |
| PROFIBUS-DP Board OPERATOR'S MANUAL | B-62924EN | |
| Ethernet Board/DATA SERVER Board OPERATOR'S MANUAL | B-63354EN | |
| AST Ethernet Board/FAST DATA SERVER OPERATOR'S MANUAL | B-63644EN | |

**Related manuals of
SERVO MOTOR
αiS/αiF/βiS series**

The following table lists the manuals related to SERVO MOTOR *αiS/αiF/βiS* series

| Manual name | Specification number |
|--|----------------------|
| FANUC AC SERVO MOTOR <i>αiS/αiF</i> series DESCRIPTIONS | B-65262EN |
| FANUC AC SERVO MOTOR <i>βiS</i> series DESCRIPTIONS | B-65302EN |
| FANUC AC SERVO MOTOR <i>αiS/αiF/βiS</i> series PARAMETER MANUAL | B-65270EN |
| FANUC AC SPINDLE MOTOR <i>αi</i> series DESCRIPTIONS | B-65272EN |
| FANUC AC SPINDLE MOTOR <i>βi</i> series DESCRIPTIONS | B-65312EN |
| FANUC AC SPINDLE MOTOR <i>αiS/βiS</i> series PARAMETER MANUAL | B-65280EN |
| FANUC SERVO AMPLIFIER <i>αi</i> series DESCRIPTIONS | B-65282EN |
| FANUC SERVO AMPLIFIER <i>βi</i> series DESCRIPTIONS | B-65322EN |
| FANUC AC SERVO MOTOR <i>αiS/αiF</i> series, FANUC AC SPINDLE MOTOR <i>αi</i> series, FANUC SERVO AMPLIFIER <i>αi</i> series MAINTENANCE MANUAL | B-65285EN |
| FANUC AC SERVO MOTOR <i>βiS</i> series, FANUC AC SPINDLE MOTOR <i>βi</i> series, FANUC SERVO AMPLIFIER <i>βi</i> series MAINTENANCE MANUAL | B-65325EN |

Table of Contents

| | |
|---|------------|
| SAFETY PRECAUTIONS | s-1 |
| PREFACE | p-1 |
| 1. DISPLAY AND OPERATION | 1 |
| 1.1 FUNCTION KEYS AND SOFT KEYS | 2 |
| 1.1.1 Soft Keys | 2 |
| 1.2 SCREEN DISPLAYED IMMEDIATELY AFTER POWER IS TURNED ON | 26 |
| 1.2.1 Slot Status Display | 26 |
| 1.2.2 Setting Module Screen | 27 |
| 1.2.3 Configuration Display of Software | 27 |
| 1.3 SYSTEM CONFIGURATION SCREEN | 28 |
| 1.3.1 Display Method | 28 |
| 1.3.2 Configuration of PCBs | 28 |
| 1.3.3 Software Configuration Screen | 29 |
| 1.3.4 Module Configuration Screen | 30 |
| 1.3.5 ID Information Screen (α i Servo Information Screen/ α i Spindle Information Screen) | 30 |
| 1.4 ALARM HISTORY SCREEN | 31 |
| 1.4.1 Alarm History Screen | 31 |
| 1.4.1.1 General | 31 |
| 1.4.1.2 Screen display | 31 |
| 1.4.1.3 Clearing alarm history | 31 |
| 1.4.1.4 Alarm display | 31 |
| 1.4.2 System Alarm History | 32 |
| 1.4.2.1 General | 32 |
| 1.4.2.2 System alarm history screen (history list screen) | 32 |
| 1.4.2.3 System alarm history screen (detail screen) | 34 |
| 1.4.2.4 Parameter | 37 |
| 1.5 EXTERNAL OPERATOR MESSAGES RECORD | 38 |
| 1.5.1 Screen Display | 38 |
| 1.5.2 Deletion of External Operator Messages Record | 38 |
| 1.5.3 Parameter | 39 |
| 1.5.4 Notes | 39 |
| 1.6 OPERATION HISTORY | 40 |
| 1.6.1 Parameter Setting | 40 |
| 1.6.2 Screen Display | 45 |
| 1.6.3 Setting the Input Signal or Output Signal to be Recorded in the Operation History | 49 |
| 1.6.4 Inputting and Outputting the Operation History Data | 53 |
| 1.6.5 Notes | 58 |
| 1.7 HELP FUNCTION | 59 |
| 1.7.1 General | 59 |
| 1.7.2 Display Method | 59 |
| 1.8 DISPLAYING DIAGNOSTIC PAGE | 62 |
| 1.8.1 Displaying Diagnostic Page | 62 |
| 1.8.2 Contents Displayed | 62 |
| 1.9 CNC STATE DISPLAY | 90 |
| 1.10 WAVEFORM DIAGNOSTIC FUNCTION | 92 |
| 1.10.1 Setting Parameters | 92 |
| 1.10.2 Waveform Diagnostic Parameter Screen | 93 |
| 1.10.3 Graphic of Wave Diagnosis Data | 96 |
| 1.10.4 Data Sampling for Storage Type Waveform Diagnosis | 98 |

| | | |
|-----------|---|------------|
| 1.10.5 | Outputting Waveform Diagnosis Data (Storage Type) | 100 |
| 1.10.6 | Notes | 103 |
| 1.11 | OPERATING MONITOR | 104 |
| 1.11.1 | Display Method | 104 |
| 1.11.2 | Parameters | 105 |
| 1.12 | LIST OF OPERATIONS | 106 |
| 1.13 | WARNING SCREEN DISPLAYED WHEN AN OPTION IS CHANGED | 116 |
| 1.14 | WARNING SCREEN DISPLAYED WHEN SYSTEM SOFTWARE IS REPLACED (SYSTEM LABEL CHECK ERROR) | 118 |
| 1.15 | MAINTENANCE INFORMATION SCREEN | 119 |
| 1.15.1 | Screen Display and Operation | 119 |
| 1.15.2 | Maintenance Information Input/Output | 122 |
| 1.16 | COLOR SETTING SCREEN (8.4" COLOR LCD) | 123 |
| 1.16.1 | Screen Display | 125 |
| 1.16.2 | Color Setting | 125 |
| 1.16.3 | Parameters | 127 |
| 1.16.4 | Notes | 128 |
| 1.17 | CONTRAST ADJUSTMENT | 129 |
| 1.18 | POWER MATE CNC MANAGER | 130 |
| 1.18.1 | Parameter | 130 |
| 1.18.2 | Screen Display | 131 |
| 1.18.3 | Parameter Input/Output | 137 |
| 1.18.4 | Notes | 139 |
| 1.19 | PERIODIC MAINTENANCE SCREENS | 140 |
| 1.19.1 | Overview | 140 |
| 1.19.2 | Screen Display and Setting | 140 |
| 1.19.3 | Status Screen Display and Setting | 141 |
| 1.19.4 | Setting Screen Display and Setting | 146 |
| 1.19.5 | Registered Data Input/Output | 148 |
| 1.19.6 | FANUC Two-Byte Character Code Table | 150 |
| 2. | HARDWARE | 156 |
| 2.1 | HARDWARE CONFIGURATION | 157 |
| 2.2 | HARDWARE OVERVIEW | 158 |
| 2.3 | TOTAL CONNECTION DIAGRAMS | 160 |
| 2.4 | CONNECTOR AND CARD CONFIGURATIONS OF PRINTED CIRCUIT BOARDS | 163 |
| 2.4.1 | Main Board | 163 |
| 2.4.2 | Inverter PCBs | 178 |
| 2.4.3 | Fast Ethernet Board | 180 |
| 2.4.4 | Fast Data Server Board | 187 |
| 2.4.5 | PROFIBUS-DP Board | 193 |
| 2.4.6 | I/O Board for 0i | 199 |
| 2.5 | UNITS AND PRINTED CIRCUIT BOARDS | 200 |
| 2.5.1 | Basic Units | 200 |
| 2.5.2 | LCD/MDI Units | 200 |
| 2.5.3 | Printed Circuit Boards | 201 |
| 2.5.4 | I/O | 203 |
| 2.5.5 | Other Units | 203 |
| 2.6 | REPLACING THE MAIN BOARD | 204 |
| 2.7 | MOUNTING AND DEMOUNTING CARD PCBS | 208 |
| 2.7.1 | Demounting a Card PCB | 209 |
| 2.7.2 | Mounting a Card PCB | 210 |

| | | |
|-----------|--|------------|
| 2.8 | MOUNTING AND DEMOUNTING DIMM MODULES | 211 |
| 2.8.1 | Demounting a DIMM Module | 212 |
| 2.8.2 | Mounting a DIMM Module | 212 |
| 2.9 | REPLACING FUSE ON CONTROL UNIT | 213 |
| 2.10 | REPLACING BATTERY | 215 |
| 2.10.1 | Battery for Separate Absolute Pulse Coders (6VDC) | 220 |
| 2.10.2 | Battery for Absolute Pulse Coder Built into the Motor (6VDC) | 221 |
| 2.11 | REPLACING FAN MOTORS | 222 |
| 2.12 | REPLACING LCD BACKLIGHT | 225 |
| 2.13 | DISTRIBUTED I/O SETTING | 234 |
| 2.14 | REPLACING FUSES ON VARIOUS UNITS | 236 |
| 2.15 | ENVIRONMENTAL REQUIREMENTS OUTSIDE THE CONTROL UNIT | 239 |
| 2.16 | ACTION AGAINST NOISE | 240 |
| 2.16.1 | Separating Signal Lines | 240 |
| 2.16.2 | Ground | 242 |
| 2.16.3 | Connecting the Ground Terminal of the Control Unit | 243 |
| 2.16.4 | Noise Suppressor | 244 |
| 2.16.5 | Cable Clamp and Shield Processing | 245 |
| 3. | INPUT AND OUTPUT OF DATA | 248 |
| 3.1 | SETTING PARAMETERS FOR INPUT/OUTPUT | 249 |
| 3.2 | INPUTTING/OUTPUTTING DATA | 251 |
| 3.2.1 | Confirming the Parameters Required for Data Output | 251 |
| 3.2.2 | Outputting CNC Parameters | 252 |
| 3.2.3 | Outputting PMC Parameters | 253 |
| 3.2.4 | Outputting Pitch Error Compensation Amount | 253 |
| 3.2.5 | Outputting Custom Macro Variable Values | 254 |
| 3.2.6 | Outputting Tool Compensation Amount | 254 |
| 3.2.7 | Outputting Part Program | 254 |
| 3.2.8 | Inputting CNC Parameters | 255 |
| 3.2.9 | Inputting PMC Parameters | 256 |
| 3.2.10 | Inputting Pitch Error Compensation Amount | 257 |
| 3.2.11 | Inputting Custom Macro Variable Values | 257 |
| 3.2.12 | Inputting Tool Compensation Amount | 258 |
| 3.2.13 | Inputting Part Programs | 258 |
| 3.3 | DATA INPUT/OUTPUT ON THE ALL IO SCREEN | 260 |
| 3.3.1 | Setting Input/Output-Related Parameters | 261 |
| 3.3.2 | Inputting and Outputting Programs | 263 |
| 3.3.3 | Inputting and Outputting Parameters | 267 |
| 3.3.4 | Inputting and Outputting Offset Data | 268 |
| 3.3.5 | Outputting Custom Macro Common Variables | 269 |
| 3.3.6 | Inputting and Outputting Floppy Files | 270 |
| 3.4 | DATA INPUT/OUTPUT USING A MEMORY CARD | 275 |
| 4. | INTERFACE BETWEEN CNC AND PMC | 286 |
| 4.1 | GENERAL OF INTERFACE | 287 |
| 4.2 | SPECIFICATION OF PMC | 288 |
| 4.2.1 | Specification | 288 |
| 4.2.2 | Address | 289 |
| 4.2.3 | System Reserve Area of Internal Relay | 290 |
| 4.2.4 | Execution Period of PMC | 293 |
| 4.2.5 | I/O Module Assignment Name List | 295 |

| | | |
|---------|--|-----|
| 4.3 | PMC SCREEN (PMC-SA1) | 298 |
| 4.3.1 | PMC Menu Selection Procedure Using Soft Keys | 298 |
| 4.3.2 | Dynamic Display of Sequence Program | 299 |
| 4.3.3 | Display of PMC Diagnosis Screen | 304 |
| 4.3.3.1 | Title screen (TITLE) | 304 |
| 4.3.3.2 | Status screen (STATUS) | 305 |
| 4.3.3.3 | Alarm screen (ALARM) | 306 |
| 4.3.3.4 | Trace screen (TRACE) | 306 |
| 4.3.4 | PMC Parameter | 308 |
| 4.3.4.1 | Input of PMC parameter from MDI | 308 |
| 4.3.4.2 | Timer screen (TIMER) | 308 |
| 4.3.4.3 | Counter screen (COUNTER) | 309 |
| 4.3.4.4 | Keep relay screen (KEEPRL) | 309 |
| 4.3.4.5 | Data table screen (C. DATA) | 312 |
| 4.3.4.6 | Setting screen | 314 |
| 4.3.5 | Input/Output of PMC Data | 315 |
| 4.3.5.1 | Start of the built-in type PMC programmer | 315 |
| 4.3.5.2 | Input/output method | 315 |
| 4.3.5.3 | Copy function (COPY) | 316 |
| 4.3.6 | SystemParameters | 317 |
| 4.3.7 | Online Monitor Setting Screen | 318 |
| 4.4 | PMC SCREEN (PMC-SB7) | 321 |
| 4.4.1 | PMC Menu Selection Procedure Using Soft Keys | 321 |
| 4.4.2 | Dynamic Display of Sequence Programs | 322 |
| 4.4.2.1 | Ladder diagram display screen | 323 |
| 4.4.2.2 | Selection monitor screen | 325 |
| 4.4.2.3 | Ladder diagram editing screen | 326 |
| 4.4.2.4 | Net editing screen | 328 |
| 4.4.3 | Display of the PMC Diagnosis Screen | 331 |
| 4.4.3.1 | Title screen | 331 |
| 4.4.3.2 | Status screen | 332 |
| 4.4.3.3 | Alarm screen | 332 |
| 4.4.3.4 | Trace function | 333 |
| 4.4.3.5 | I/O Link connection check screen | 337 |
| 4.4.4 | PMC Parameters | 337 |
| 4.4.4.1 | Parameter input/output method | 337 |
| 4.4.4.2 | TIMER screen | 338 |
| 4.4.4.3 | COUNTER screen | 339 |
| 4.4.4.4 | KEEP RELAY screen | 340 |
| 4.4.4.5 | Data table screen | 343 |
| 4.4.4.6 | Setting screens | 345 |
| 4.4.5 | PMC Data Input/Output | 348 |
| 4.4.5.1 | Starting the built-in programmer | 348 |
| 4.4.5.2 | Input/output method | 349 |
| 4.4.6 | SystemParameters | 350 |
| 4.4.7 | Online Monitor Setting Screen | 352 |
| 4.5 | LIST OF SIGNALS BY EACH MODE | 354 |
| 4.6 | LIST OF INPUT/OUTPUT SIGNALS | 356 |
| 4.7 | LIST OF ADDRESSES | 371 |

| | |
|---|------------|
| 5. FOCAS1/ETHERNET PARAMETER SETTING | 398 |
| 6. DIGITAL SERVO | 401 |
| 6.1 INITIAL SETTING SERVO PARAMETERS | 402 |
| 6.2 SERVO TUNING SCREEN | 412 |
| 6.2.1 Parameter Setting | 412 |
| 6.2.2 Displaying Servo Tuning Screen | 412 |
| 6.3 ADJUSTING REFERENCE POSITION (DOG METHOD) | 415 |
| 6.3.1 General | 415 |
| 6.4 DOGLESS REFERENCE POSITION SETTING | 418 |
| 6.4.1 General | 418 |
| 6.4.2 Operation | 418 |
| 6.4.3 AssociatedParameters | 419 |
| 6.5 α i SERVO WARNING INTERFACE | 420 |
| 6.6 α i SERVO INFORMATION SCREEN | 422 |
| 7. AC SPINDLE (SERIAL INTERFACE) | 426 |
| 7.1 AC SPINDLE (SERIAL INTERFACE) | 427 |
| 7.1.1 Outline of Spindle Control | 427 |
| 7.1.1.1 Method A of gear change for machining center (PRM 3705#2=0) | 429 |
| 7.1.1.2 Method B of gear change for machining center (PRM 3705#2=1) | 429 |
| 7.1.1.3 T series | 429 |
| 7.1.2 Spindle Setting and Tuning Screen | 430 |
| 7.1.2.1 Display method | 430 |
| 7.1.2.2 Spindle setting screen | 430 |
| 7.1.2.3 Spindle tuning screen | 431 |
| 7.1.2.4 Spindle monitor screen | 433 |
| 7.1.2.5 Correspondence between operation mode and parameters on spindle tuning screen | 435 |
| 7.1.3 Automatic Setting of Standard Parameters | 438 |
| 7.1.4 Warning Interface for the α i Spindle | 440 |
| 7.1.5 α i Spindle Error State Messages | 442 |
| 7.1.6 α i Spindle Information Screen | 443 |
| 7.2 AC SPINDLE (ANALOG INTERFACE) | 447 |
| 7.2.1 Outline of Spindle Control | 447 |
| 7.2.1.1 Block diagram | 448 |
| 7.2.1.2 Calculation of S analog voltage and related parameters | 449 |
| 7.2.1.3 Tuning S analog voltage (D/A converter) | 451 |
| 8. TROUBLESHOOTING | 453 |
| 8.1 CORRECTIVE ACTION FOR FAILURES | 455 |
| 8.1.1 Investigating the Conditions Under which Failure Occurred | 455 |
| 8.2 NO MANUAL OPERATION NOR AUTOMATIC OPERATION CAN BE EXECUTED | 457 |
| 8.3 JOG OPERATION CANNOT BE DONE | 461 |
| 8.4 MANUAL HANDLE OPERATION CANNOT BE DONE | 465 |
| 8.5 AUTOMATIC OPERATION CANNOT BE DONE | 470 |
| 8.6 CYCLE START LED SIGNAL HAS TURNED OFF | 478 |
| 8.7 NOTHING IS DISPLAYED ON THE LCD WHEN THE POWER IS TURNED ON | 480 |

| | | |
|------|--|-----|
| 8.8 | INPUT FROM AND OUTPUT TO I/O DEVICES CANNOT BE PERFORMED INPUT/OUTPUT CANNOT BE PERFORMED PROPERLY | 482 |
| 8.9 | IN A CONNECTOR PANEL I/O UNIT, DATA IS INPUT TO AN UNEXPECTED ADDRESS .. | 484 |
| 8.10 | IN A CONNECTOR PANEL I/O UNIT, NO DATA IS OUTPUT TO AN EXPANSION UNIT ... | 485 |
| 8.11 | ALARM 85 TO 87 (READER/PUNCHER INTERFACE ALARM) | 486 |
| 8.12 | ALARM 90 (REFERENCE POSITION RETURN IS ABNORMAL) | 490 |
| 8.13 | ALARM 300 (REQUEST FOR REFERENCE POSITION RETURN) | 492 |
| 8.14 | ALARM 401 (V READY OFF) | 493 |
| 8.15 | ALARM 404 (V READY ON) | 495 |
| 8.16 | ALARM 462 (SEND CNC DATA FAILED) ALARM 463 (SEND SLAVE DATA FAILED) | 496 |
| 8.17 | ALARM 417 (DIGITAL SERVO SYSTEM IS ABNORMAL) | 497 |
| 8.18 | ALARM 700 (OVERHEAT: CONTROL UNIT) | 498 |
| 8.19 | ALARM 701 (OVERHEAT: FAN MOTOR) | 499 |
| 8.20 | ALARM 704 (SPINDLE SPEED FLUCTUATION DETECTION ALARM) | 500 |
| 8.21 | ALARM 749 (SERIAL SPINDLE COMMUNICATION ERROR) | 501 |
| 8.22 | ALARM 750 (SPINDLE SERIAL LINK STARTUP FAILURE) | 502 |
| 8.23 | ALARM 5134 (FSSB: OPEN READY TIME OUT) ALARM 5135 (FSSB: ERROR MODE) ALARM 5137 (FSSB: CONFIGURATION ERROR) ALARM 5197 (FSSB: OPEN TIME OUT) ALARM 5198 (FSSB: ID DATA NOT READ) | 504 |
| 8.24 | ALARM 5136 (FSSB: NUMBER OF AMPS IS SMALL) | 506 |
| 8.25 | ALARM 900 (ROM PARITY) | 507 |
| 8.26 | ALARMS 912 TO 919 (DRAM PARITY) | 508 |
| 8.27 | ALARM 920 (SERVO ALARMS) | 509 |
| 8.28 | ALARM 926 (FSSB ALARM) | 510 |
| 8.29 | ALARM 930 (CPU INTERRUPT) | 513 |
| 8.30 | ALARM 935 (SRAM ECC ERROR) | 514 |
| 8.31 | ALARM 950 (PMC SYSTEM ALARM) | 515 |
| 8.32 | ALARM 951 (PMC WATCHDOG ALARM) | 518 |
| 8.33 | ALARM 972 (NMI ALARM ON AN OPTION BOARD) (SERIES 0i-C ONLY) | 519 |
| 8.34 | ALARM 973 (NMI ALARM WITH AN UNKNOWN CAUSE) | 520 |
| 8.35 | ALARM 974 (F-BUS ERROR) | 521 |
| 8.36 | ALARM 975 (BUS ERROR) | 522 |
| 8.37 | ALARM 976 (LOCAL BUS ERROR) | 523 |
| 8.38 | SERVO ALARMS | 524 |
| 8.39 | SPC ALARMS | 527 |
| 8.40 | SPINDLE ALARMS | 528 |

APPENDIX

| | |
|---------------------------------------|------------|
| A. ALARM LIST | 531 |
| A.1 LIST OF ALARM CODES (CNC) | 532 |
| A.2 LIST OF ALARMS (PMC) | 569 |
| A.3 ALARM LIST (SERIAL SPINDLE) | 594 |

| | | |
|-----------|---|------------|
| A.4 | ERROR CODES (SERIAL SPINDLE) | 606 |
| B. | LIST OF MAINTENANCE PARTS | 608 |
| C. | BOOT SYSTEM | 609 |
| C.1 | OVERVIEW | 610 |
| C.1.1 | Starting the Boot System | 610 |
| C.1.2 | System Files and User Files | 611 |
| C.2 | SCREEN CONFIGURATION AND OPERATING PROCEDURE | 612 |
| C.2.1 | System Data Loading Screen | 613 |
| C.2.2 | System Data Check Screen | 615 |
| C.2.3 | System Data Delete Screen | 617 |
| C.2.4 | System Data Save Screen | 618 |
| C.2.5 | SRAM Data Backup Screen | 620 |
| C.2.6 | Memory Card File Delete Screen | 623 |
| C.2.7 | Memory Card Format Function | 624 |
| C.2.8 | Load Basic System Function | 625 |
| C.3 | ERROR MESSAGES AND REQUIRED ACTIONS | 627 |
| D. | FSSB START-UP PROCEDURE/MATERIALS | 630 |
| D.1 | OVERVIEW | 631 |
| D.2 | SLAVE | 632 |
| D.3 | AUTOMATIC SETTING | 633 |
| D.3.1 | [Sample Setting 1] General Configuration (Semi-Closed Loop) | 635 |
| D.3.2 | [Sample Setting 2] General Configuration (Closed Loop) | 636 |
| D.3.3 | [Sample Setting 3] When the C-Axis is a Cs Axis | 638 |
| D.4 | MANUAL SETTING 2 | 640 |
| D.5 | MANUAL SETTING 1 | 646 |
| D.6 | ALARMS | 647 |
| D.7 | ACTIONS FOR TROUBLE ENCOUNTERED AT START-UP TIME | 652 |
| D.8 | FSSB DATA DISPLAY | 654 |
| D.8.1 | Amplifier Setting Screen | 654 |
| D.8.2 | Axis Setting Screen | 655 |
| D.8.3 | Amplifier Maintenance Screen | 656 |
| E. | NOTATION OF MDI KEYS | 658 |

1

DISPLAY AND OPERATION

This chapter describes how to display various screens by the function keys. The screens used for maintenance are respectively displayed.

| | | |
|------|--|-----|
| 1.1 | FUNCTION KEYS AND SOFT KEYS | 2 |
| 1.2 | SCREEN DISPLAYED IMMEDIATELY AFTER POWER IS TURNED ON | 26 |
| 1.3 | SYSTEM CONFIGURATION SCREEN | 28 |
| 1.4 | ALARM HISTORY SCREEN | 31 |
| 1.5 | EXTERNAL OPERATOR MESSAGES RECORD | 38 |
| 1.6 | OPERATION HISTORY | 40 |
| 1.7 | HELP FUNCTION | 59 |
| 1.8 | DISPLAYING DIAGNOSTIC PAGE | 62 |
| 1.9 | CNC STATE DISPLAY | 90 |
| 1.10 | WAVEFORM DIAGNOSTIC FUNCTION | 92 |
| 1.11 | OPERATING MONITOR | 104 |
| 1.12 | LIST OF OPERATIONS | 106 |
| 1.13 | WARNING SCREEN DISPLAYED WHEN AN OPTION IS CHANGED | 116 |
| 1.14 | WARNING SCREEN DISPLAYED WHEN SYSTEM SOFTWARE IS REPLACED (SYSTEM LABEL CHECK ERROR) | 118 |
| 1.15 | MAINTENANCE INFORMATION SCREEN | 119 |
| 1.16 | COLOR SETTING SCREEN (8.4" COLOR LCD) | 123 |
| 1.17 | CONTRAST ADJUSTMENT | 129 |
| 1.18 | POWER MATE CNC MANAGER | 130 |
| 1.19 | PERIODIC MAINTENANCE SCREENS | 140 |

1.1 FUNCTION KEYS AND SOFT KEYS







Operations and soft key display statuses for each function key are described below:

1.1.1 Soft Keys

To display a more detailed screen, press a function key followed by a soft key. Soft keys are also used for actual operations.

The following illustrates how soft key displays are changed by pressing each function key.

The symbols in the following figures mean as shown below :

| | | |
|---|---|---|
|  | : | Indicates screens |
|  | : | Indicates a screen that can be displayed by pressing a function key(*1) |
|  | : | Indicates a soft key(*2) |
|  | : | Indicates input from the MDI panel. |
|  | : | Indicates a soft key displayed in green (or highlighted). |
|  | : | Indicates the continuous menu key (rightmost soft key)(*3). |

*1 Press function keys to switch between screens that are used frequently.

*2 Some soft keys are not displayed depending on the option configuration.

*3 In some cases, the continuous menu key is omitted when the 12 soft keys type is used.

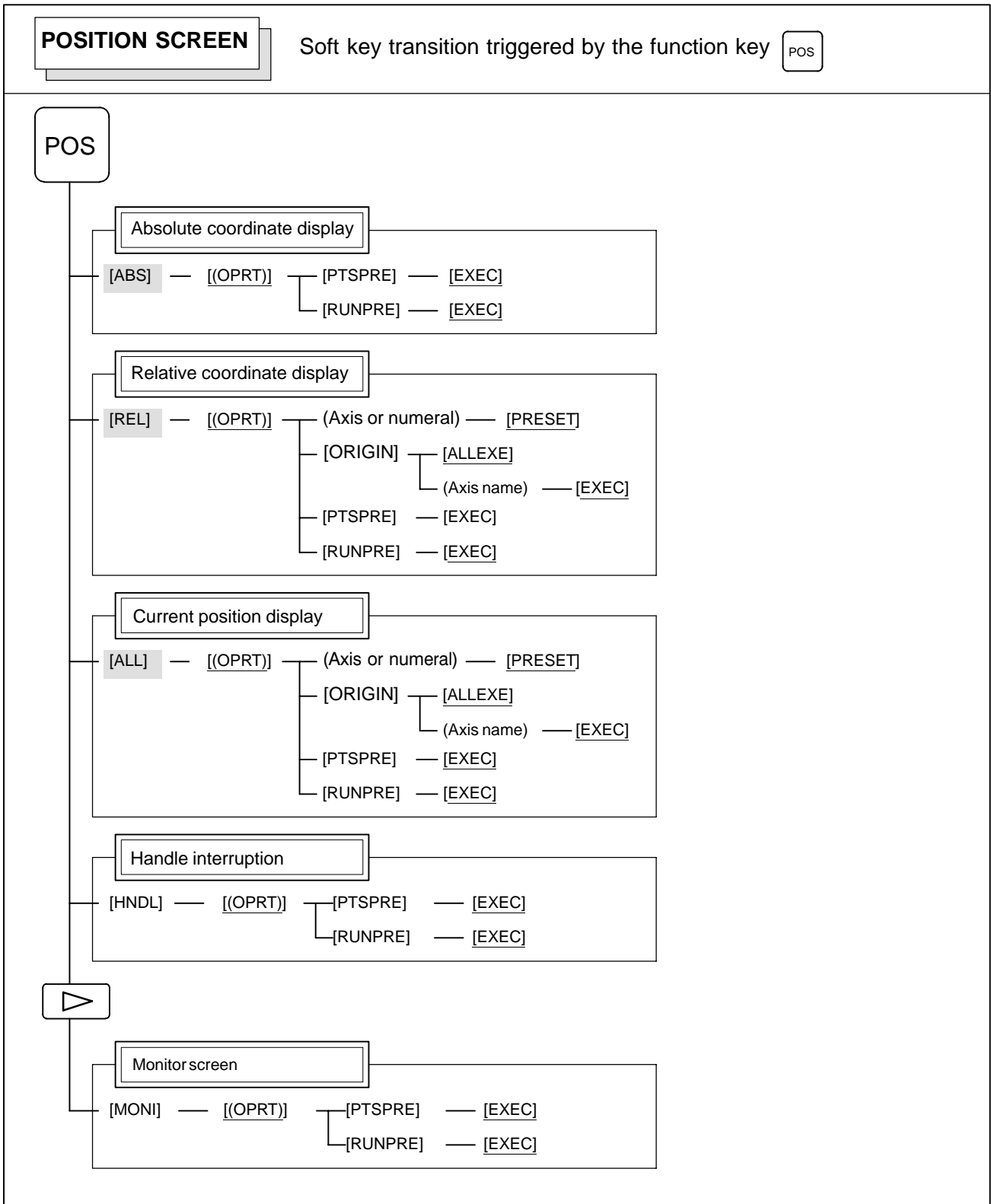

PROGRAM SCREEN

Soft key transition triggered by the function key in the MEM mode



PROG

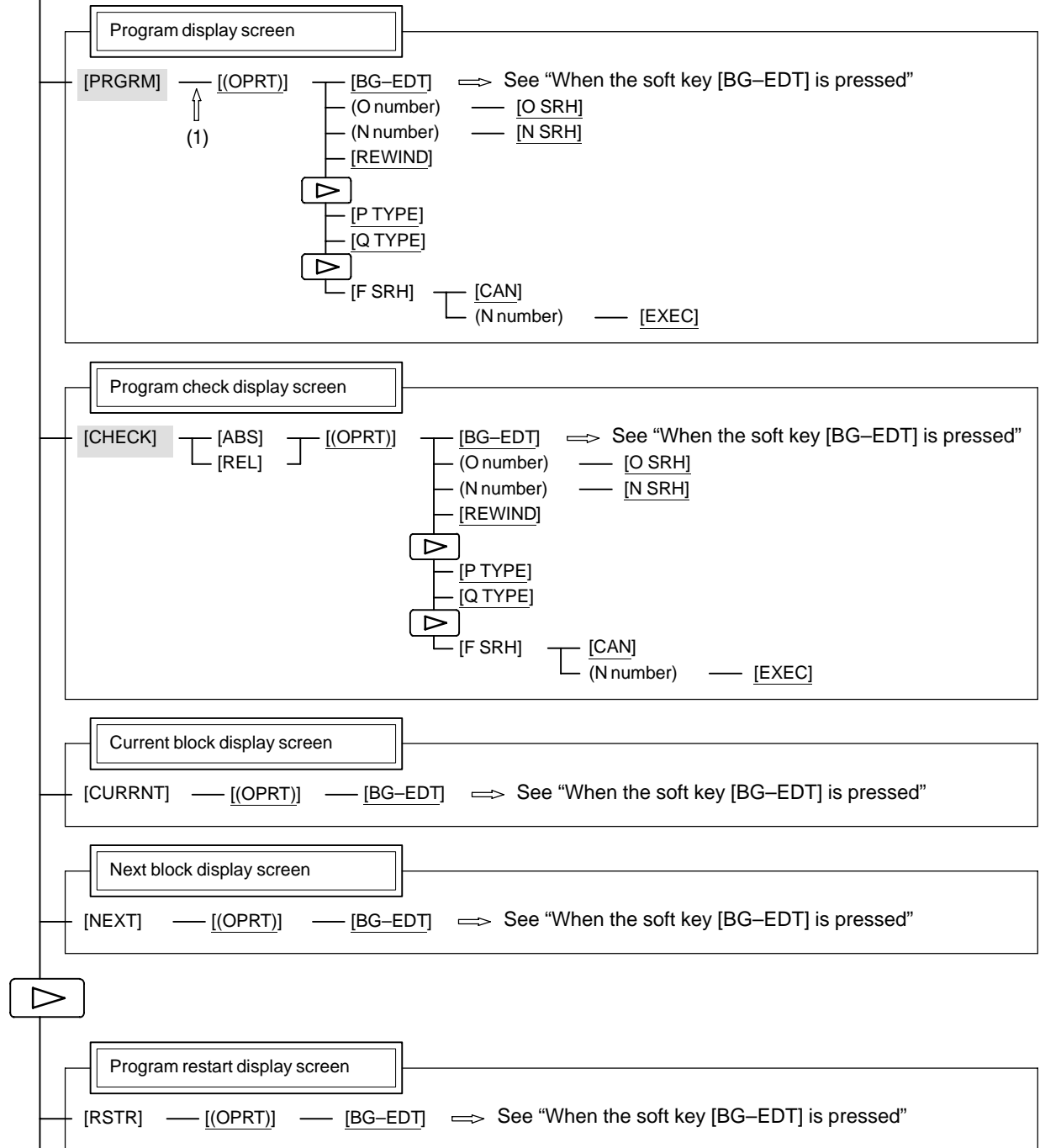

(2)(Continued on the next page)

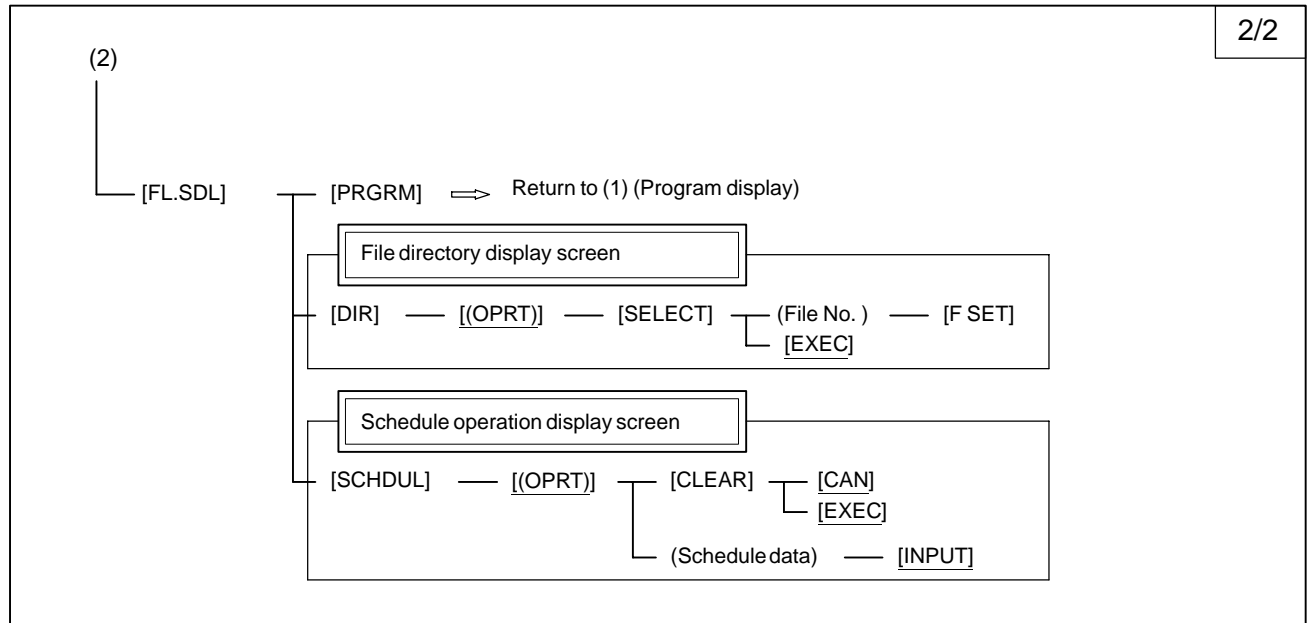

PROGRAM SCREEN

Soft key transition triggered by the function key **PROG** in the EDIT mode

PROG

1/2

PROG

Program display

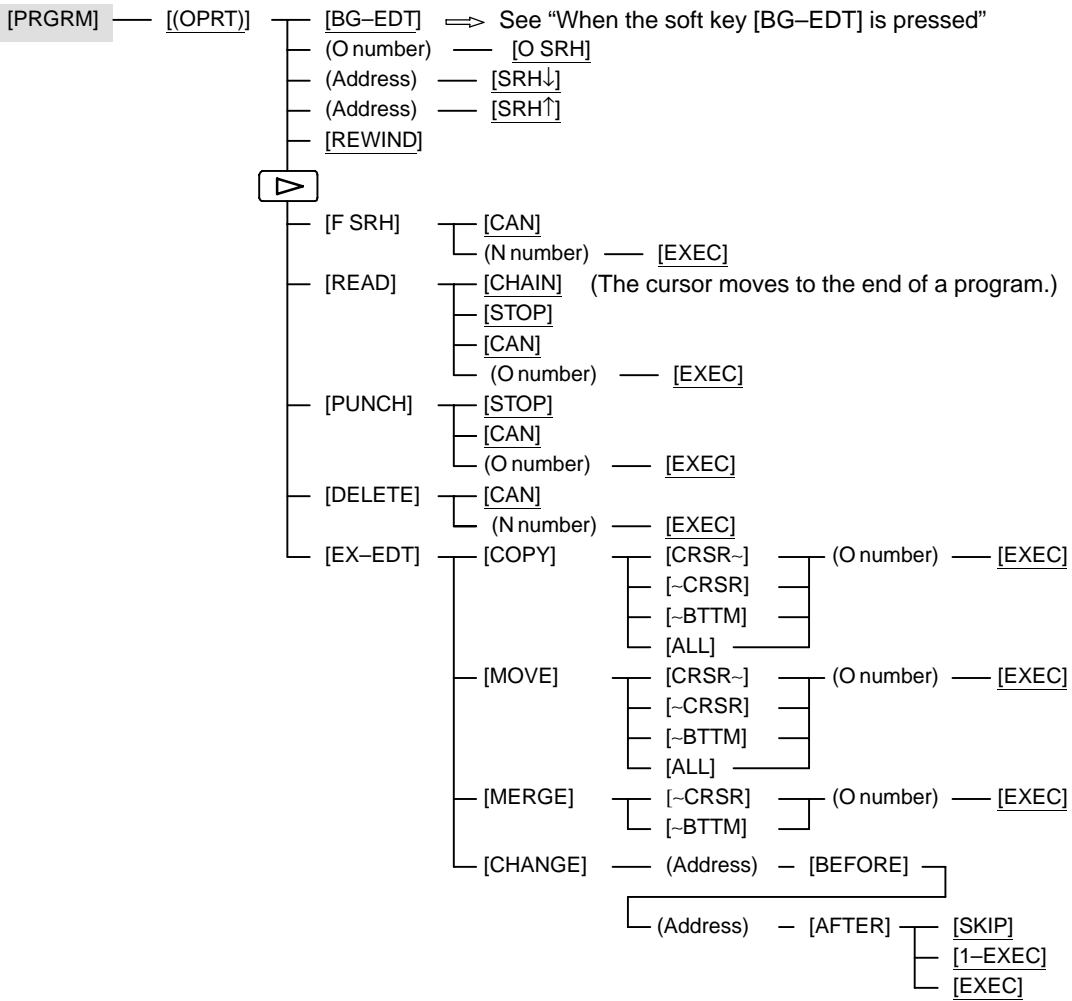

(1)(Continued on the next page)

(1)

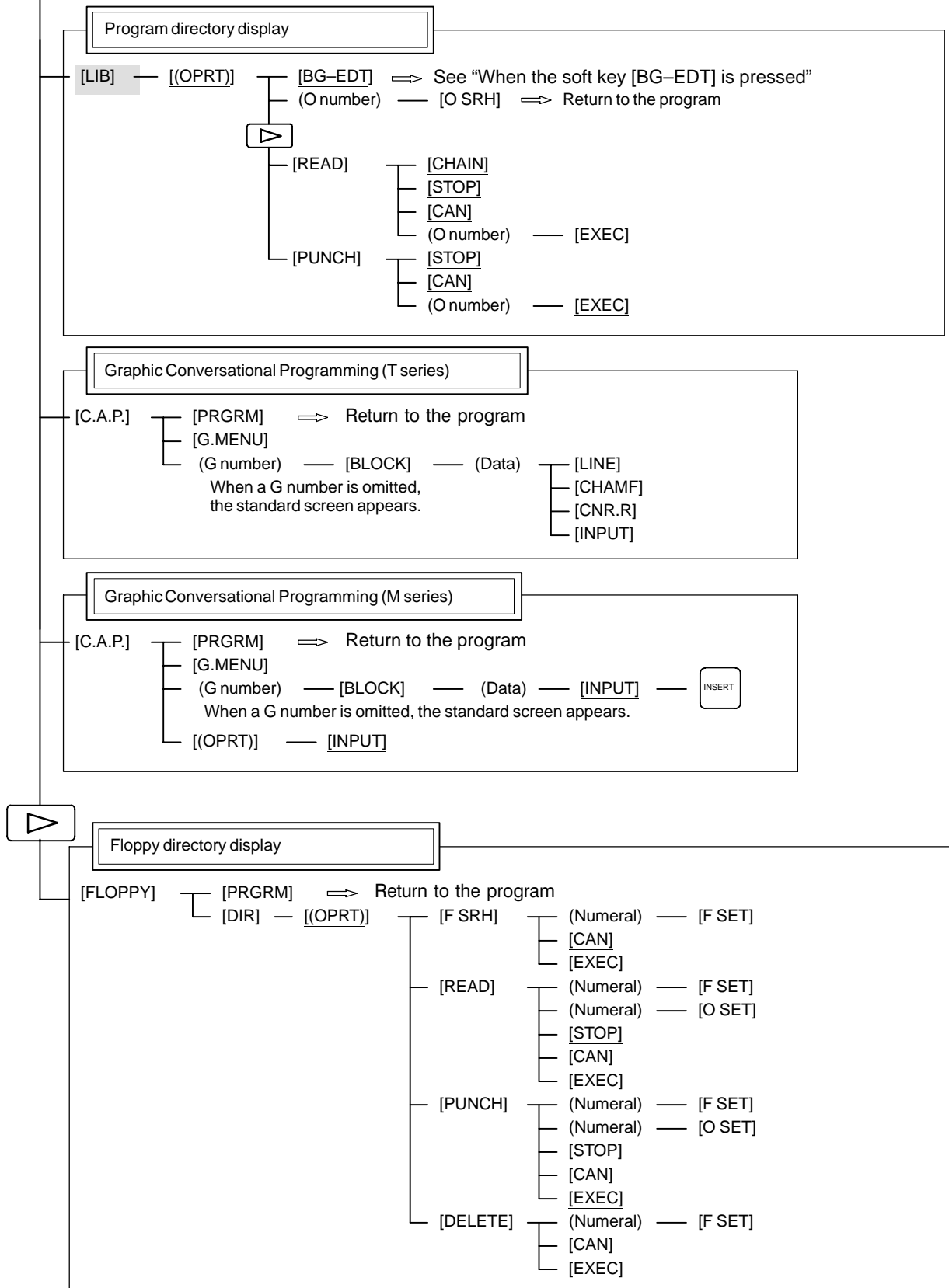

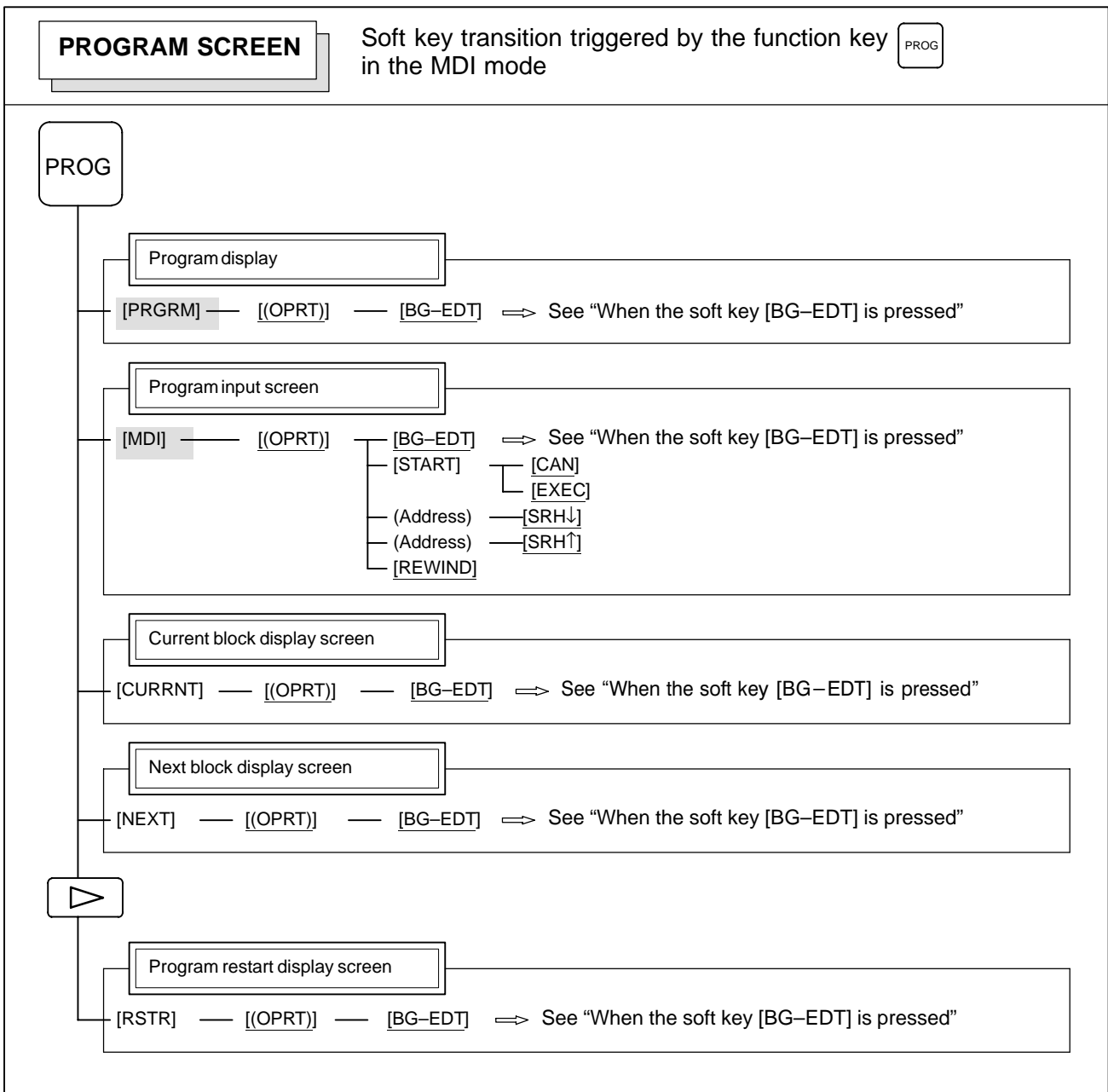

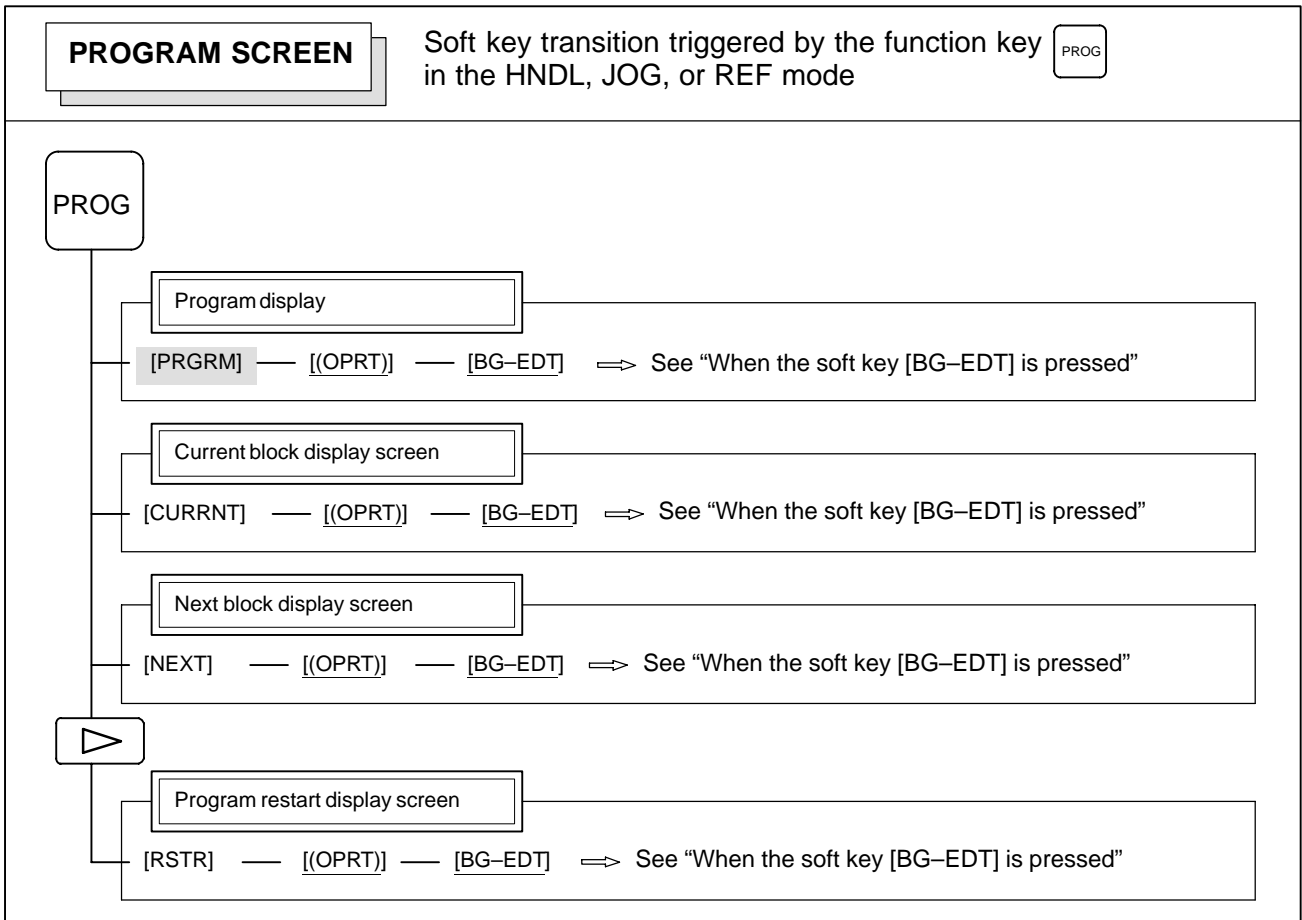

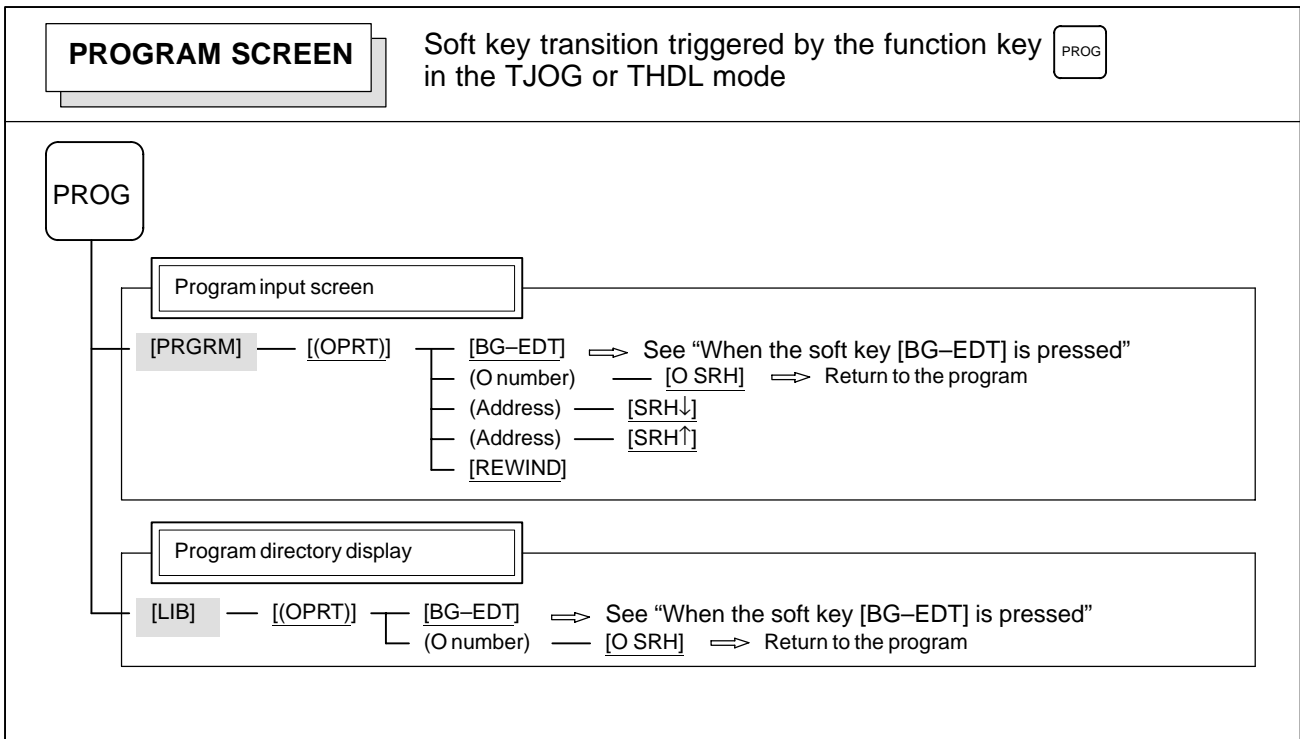

PROGRAM SCREEN

Soft key transition triggered by the function key PROG
 (When the soft key [BG-EDT] is pressed in all modes)

1/2

PROG

Program display

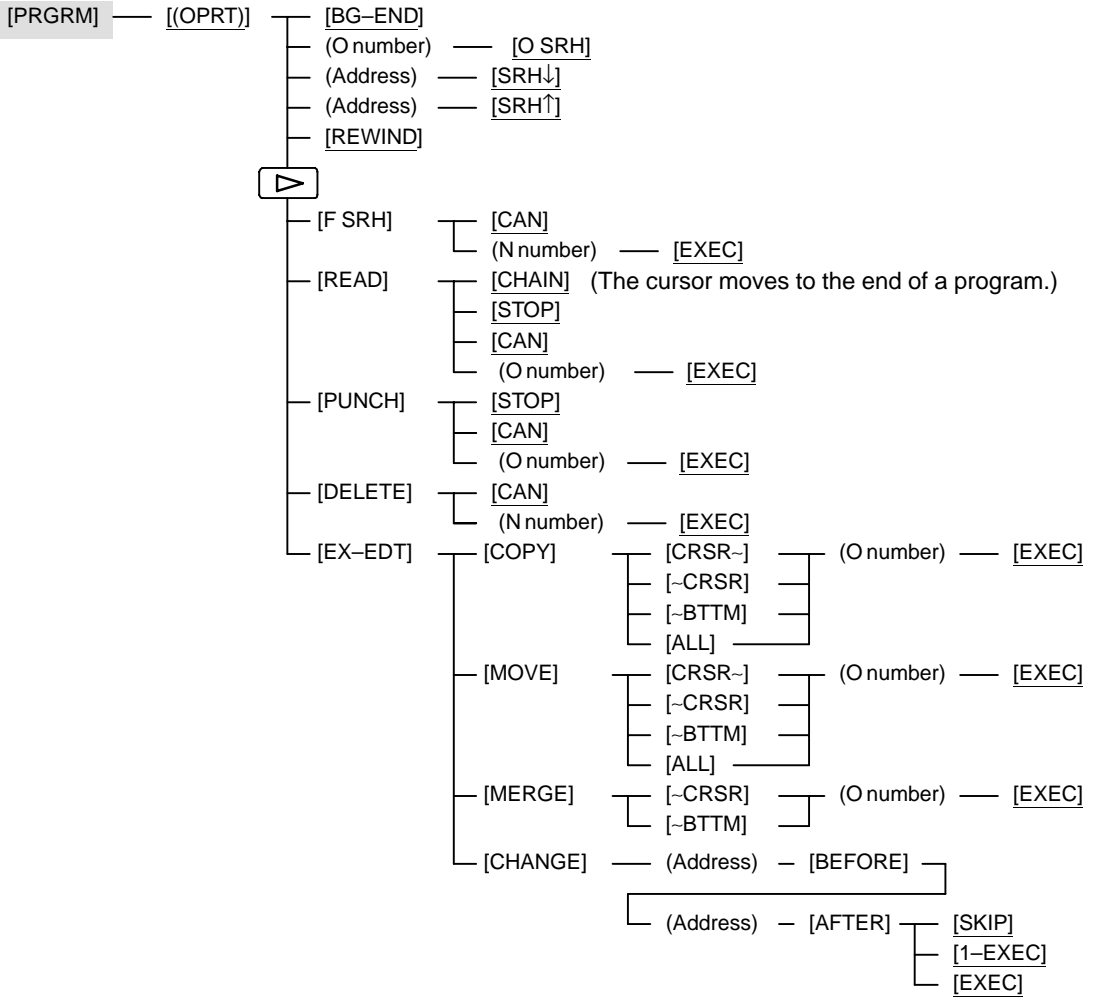

(1)(Continued on the next page)

(1)

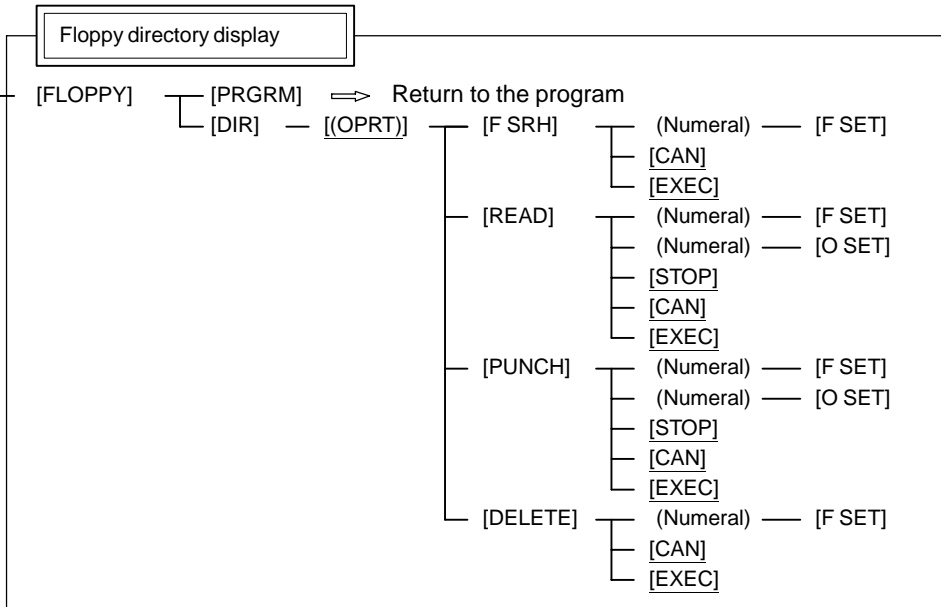
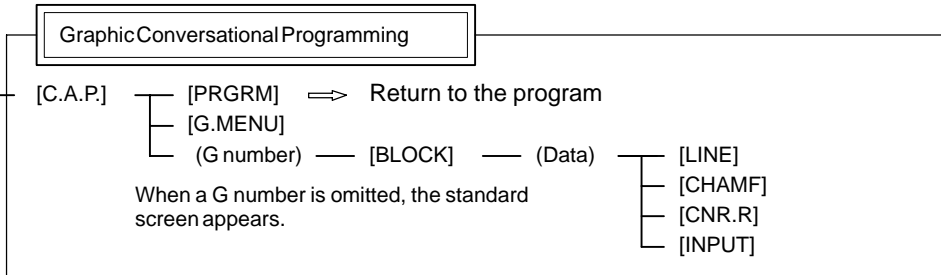
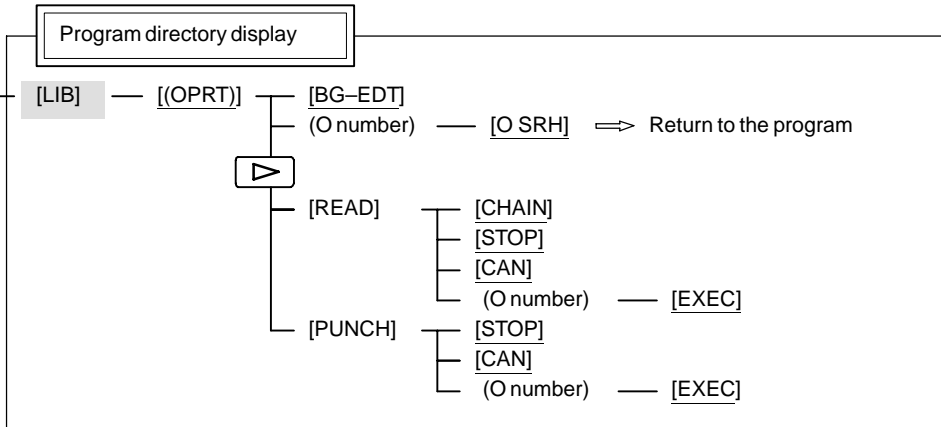

OFFSET/SETTING SCREEN (T series)

Soft key transition triggered by the function key 

OFFSET
SETTING

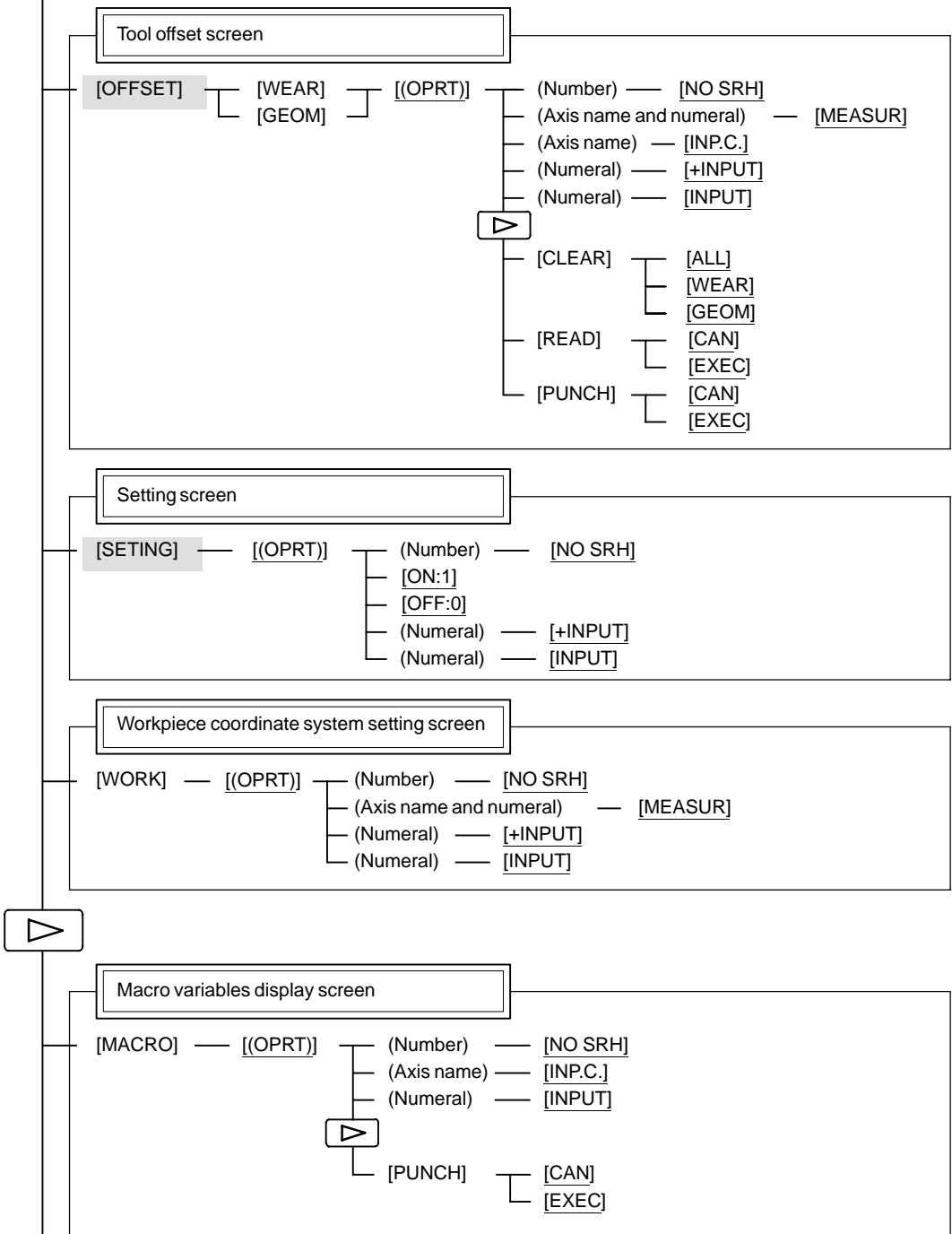

(1)(Continued on the next page)

(1)

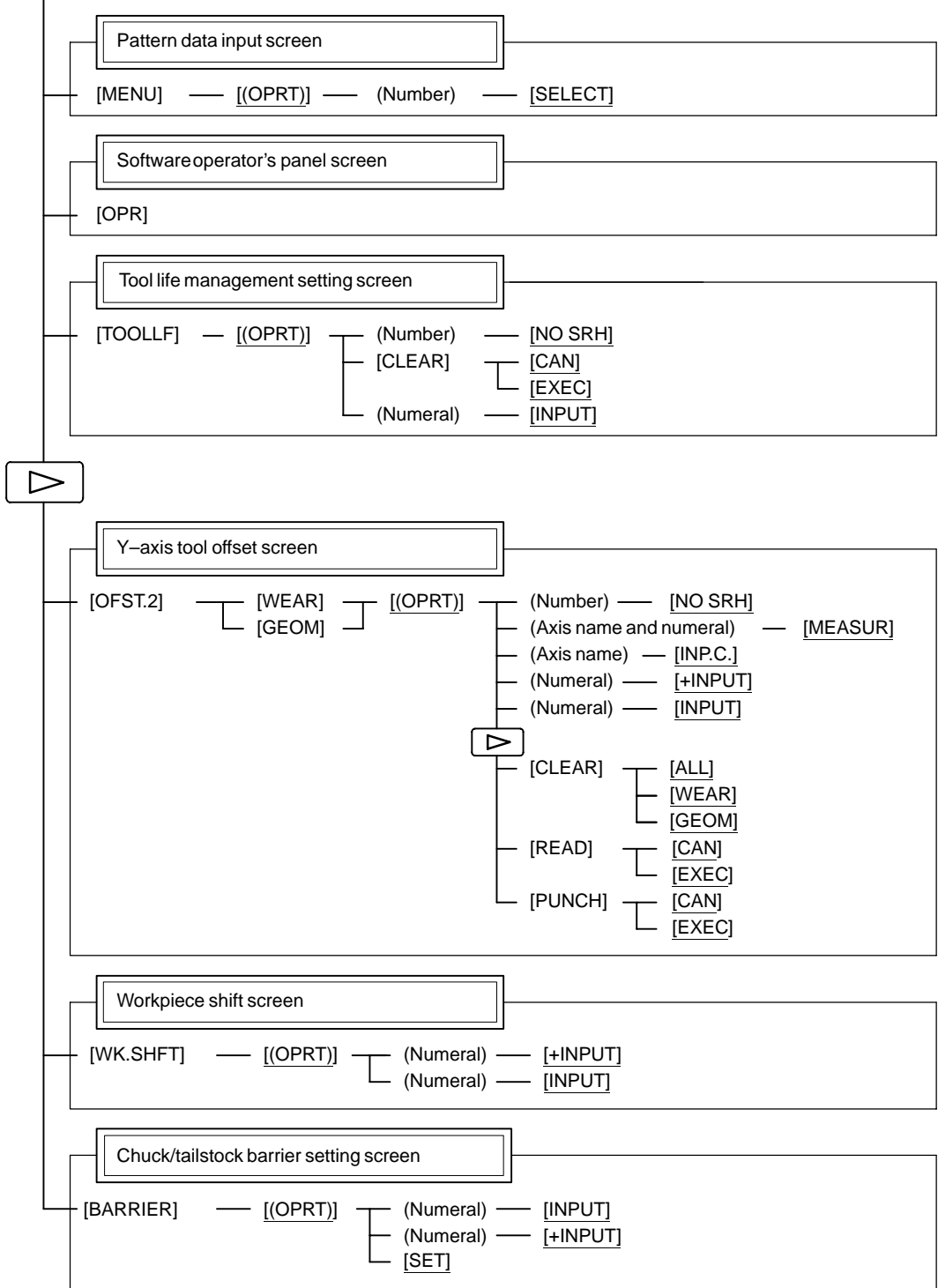

OFFSET/SETTING SCREEN (M series)

Soft key transition triggered by the function key 

OFFSET
SETTING

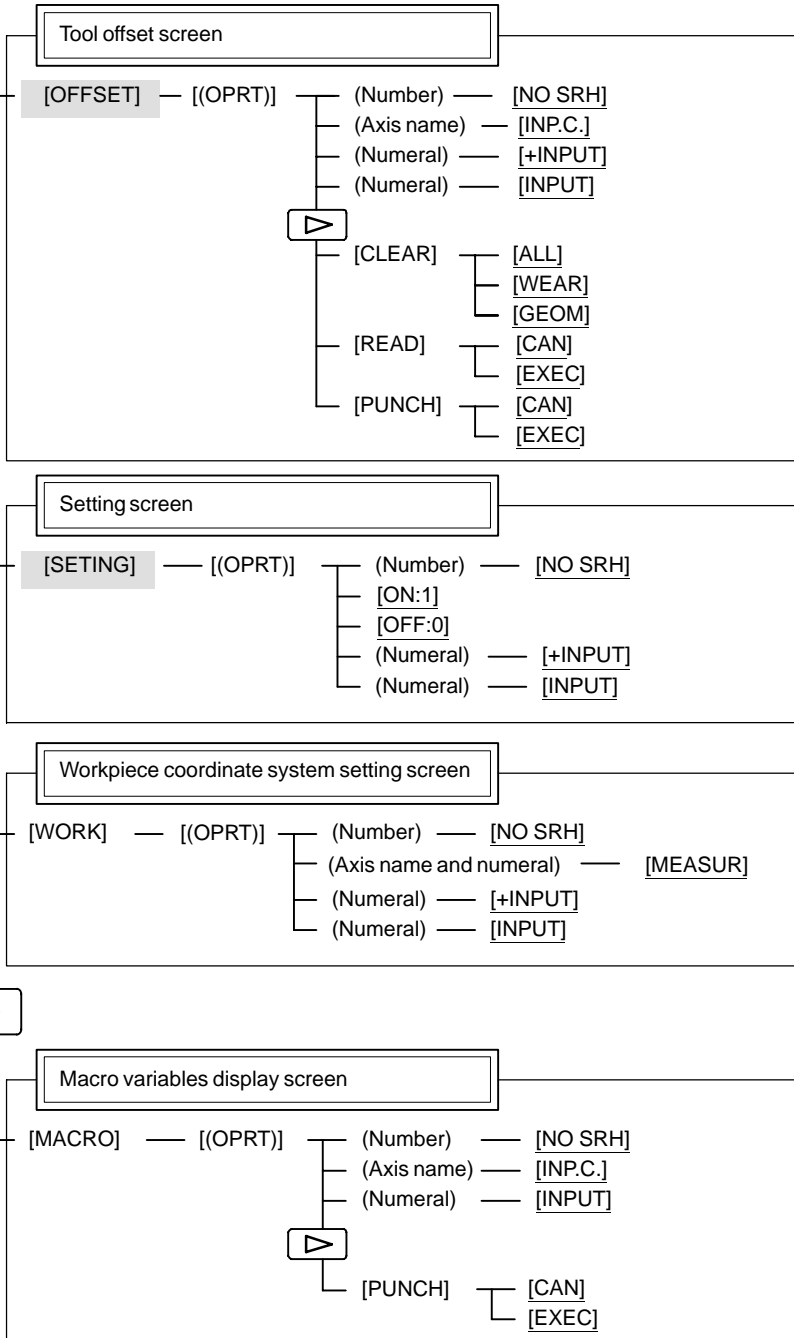

(1)(Continued on the next page)

(1)

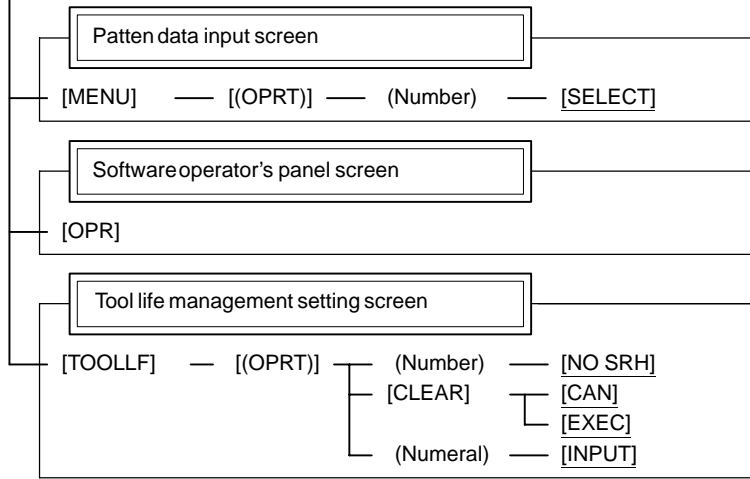

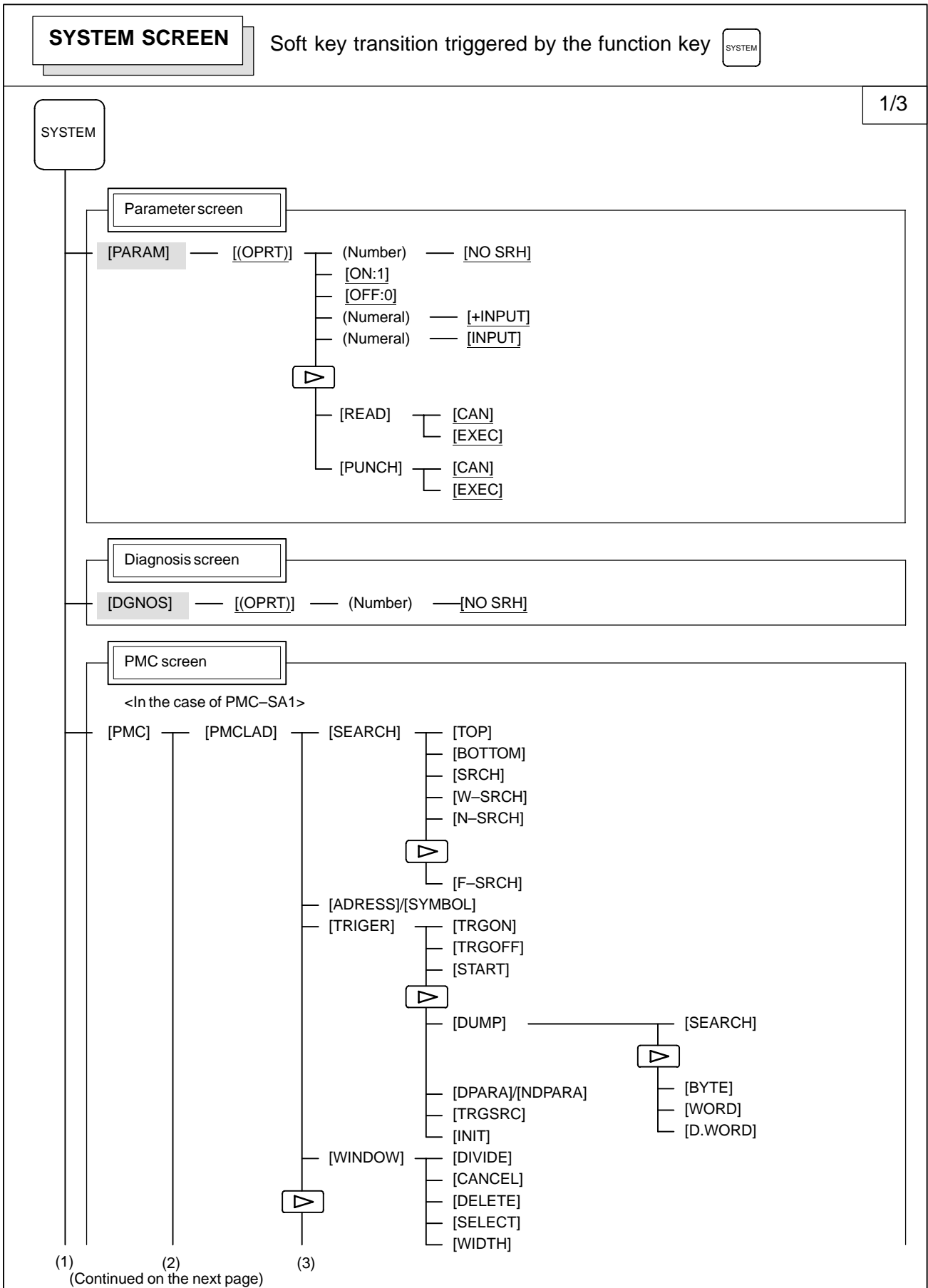

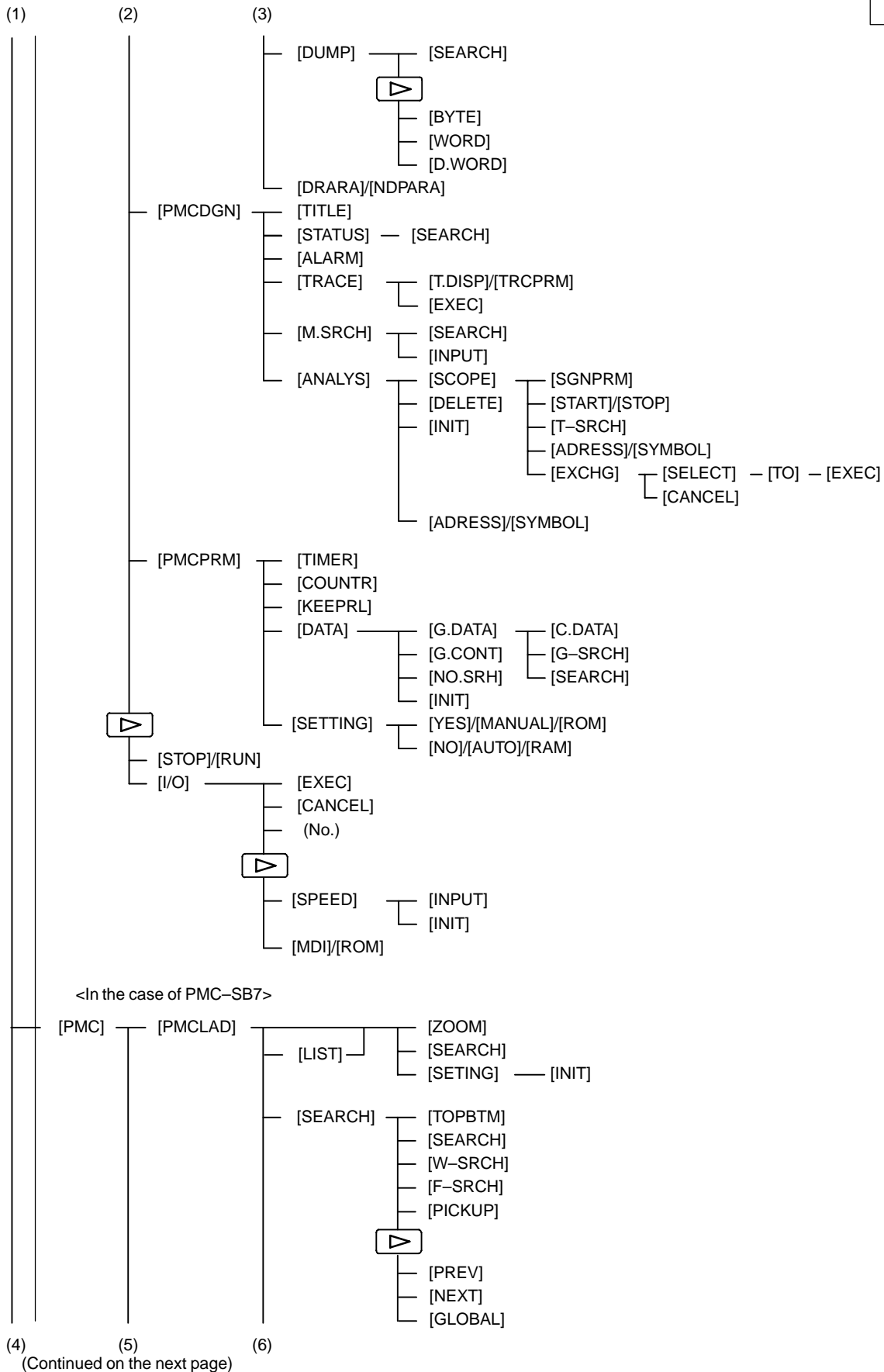

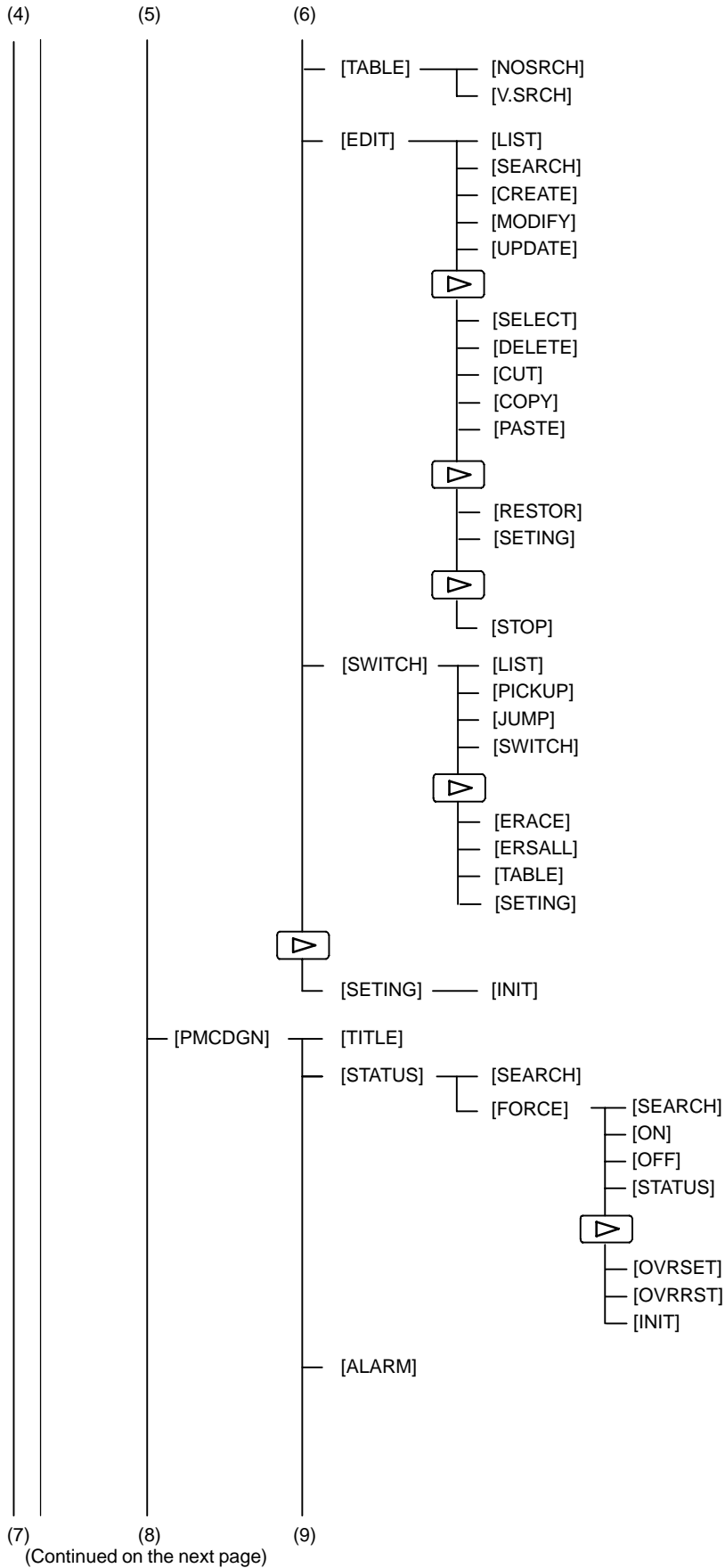

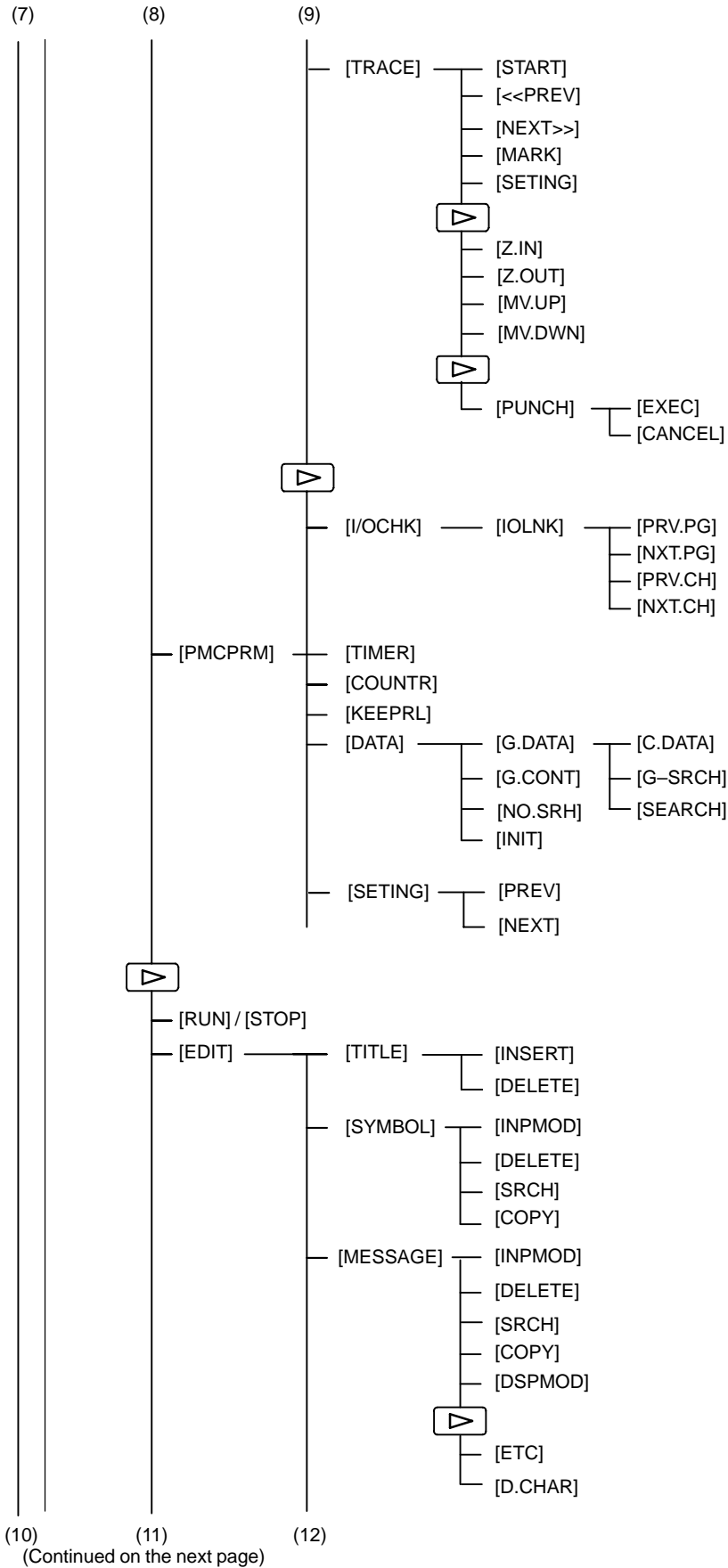

(Continued on the next page)

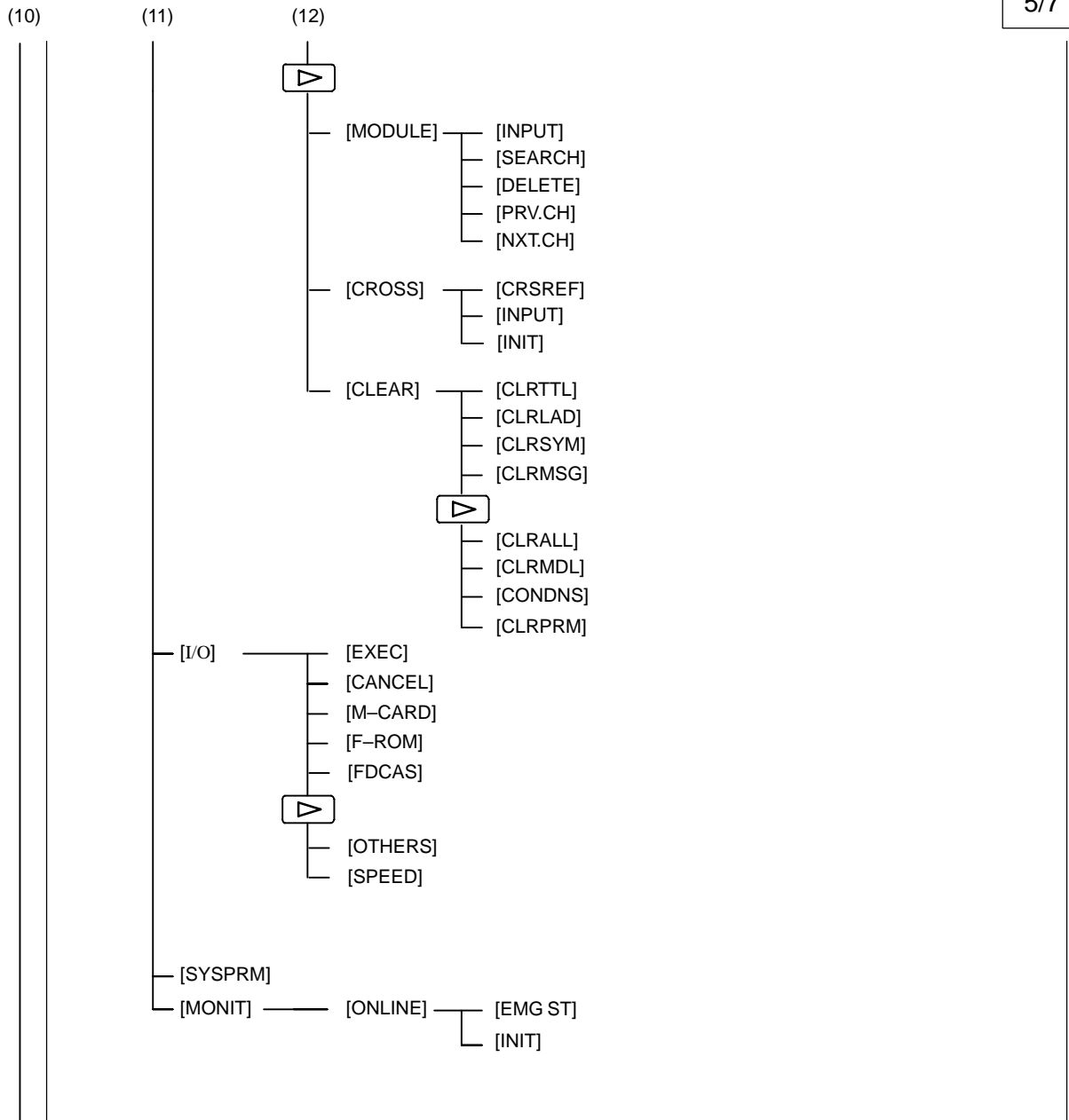

System configuration screen

[SYSTEM]

(13)
(Continued on the next page)

(13)

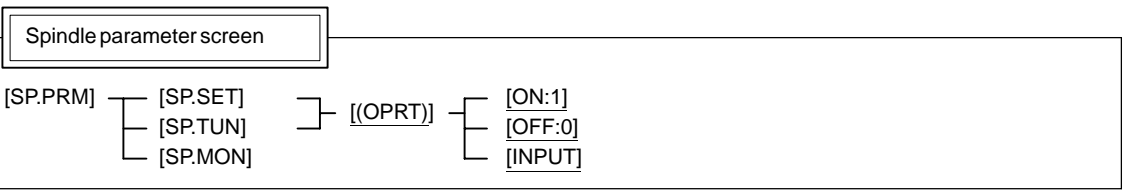
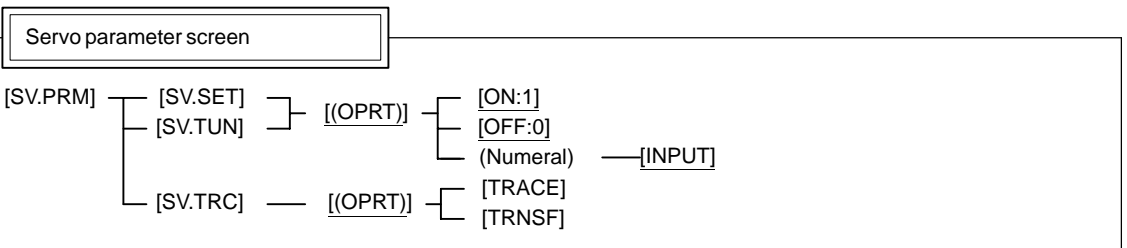
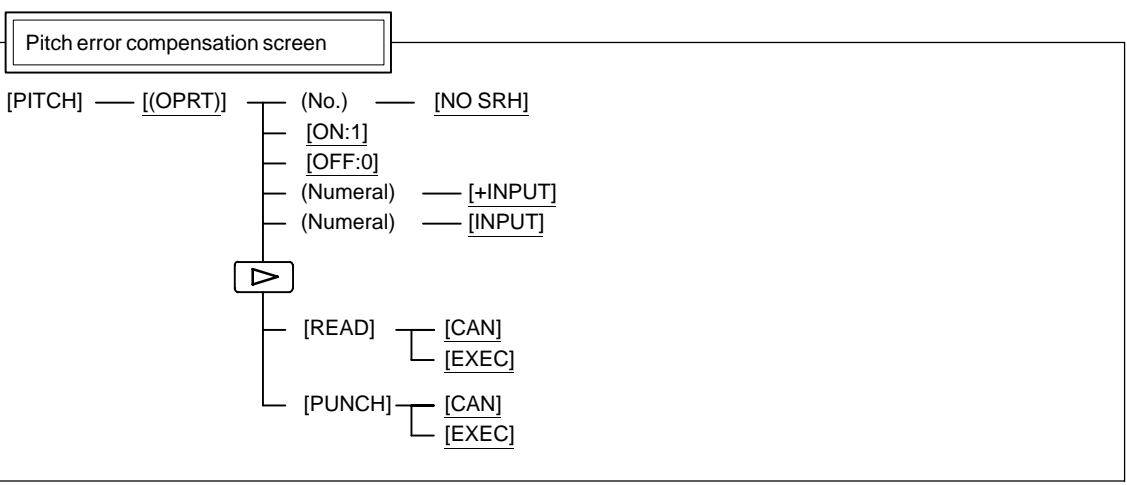
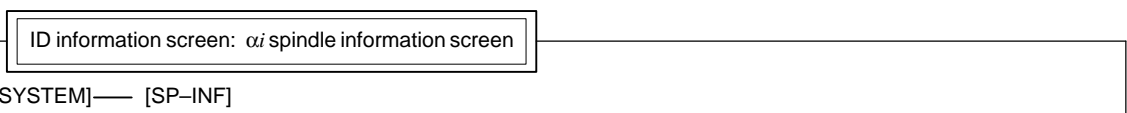
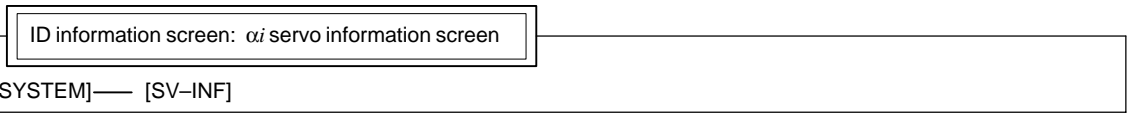

(14)

(Continued on the next page)

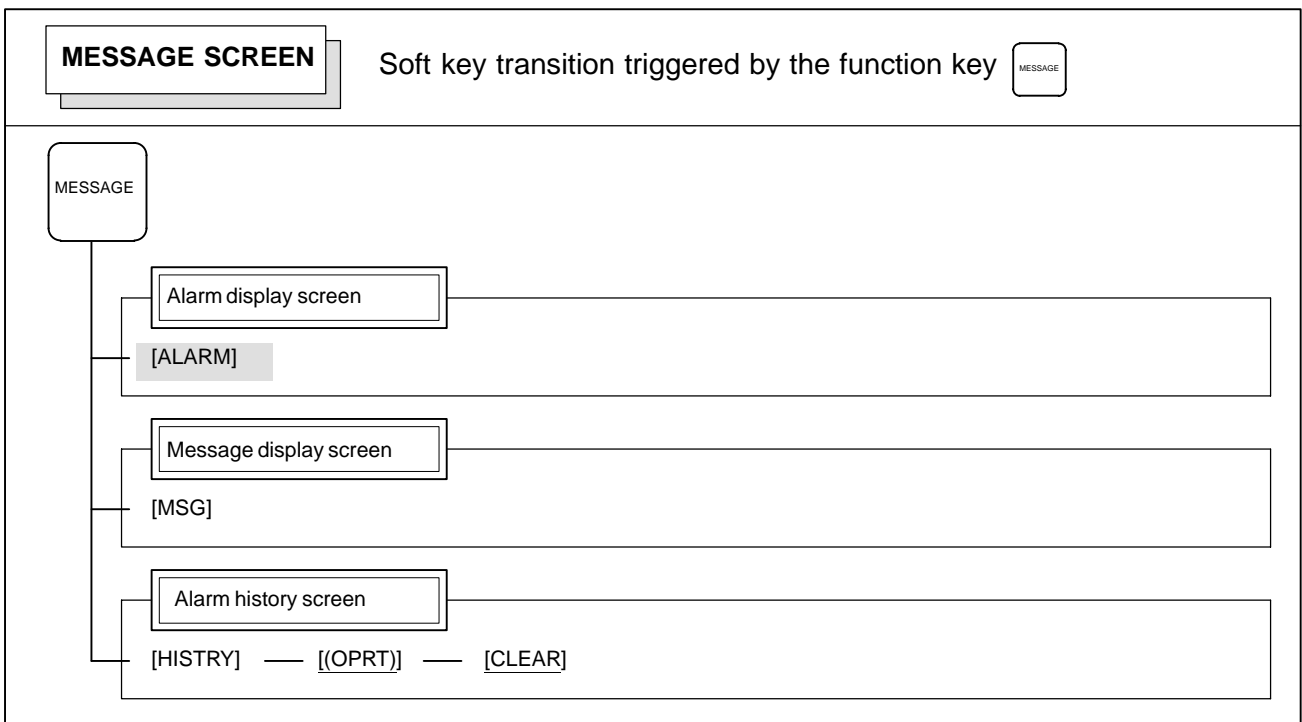
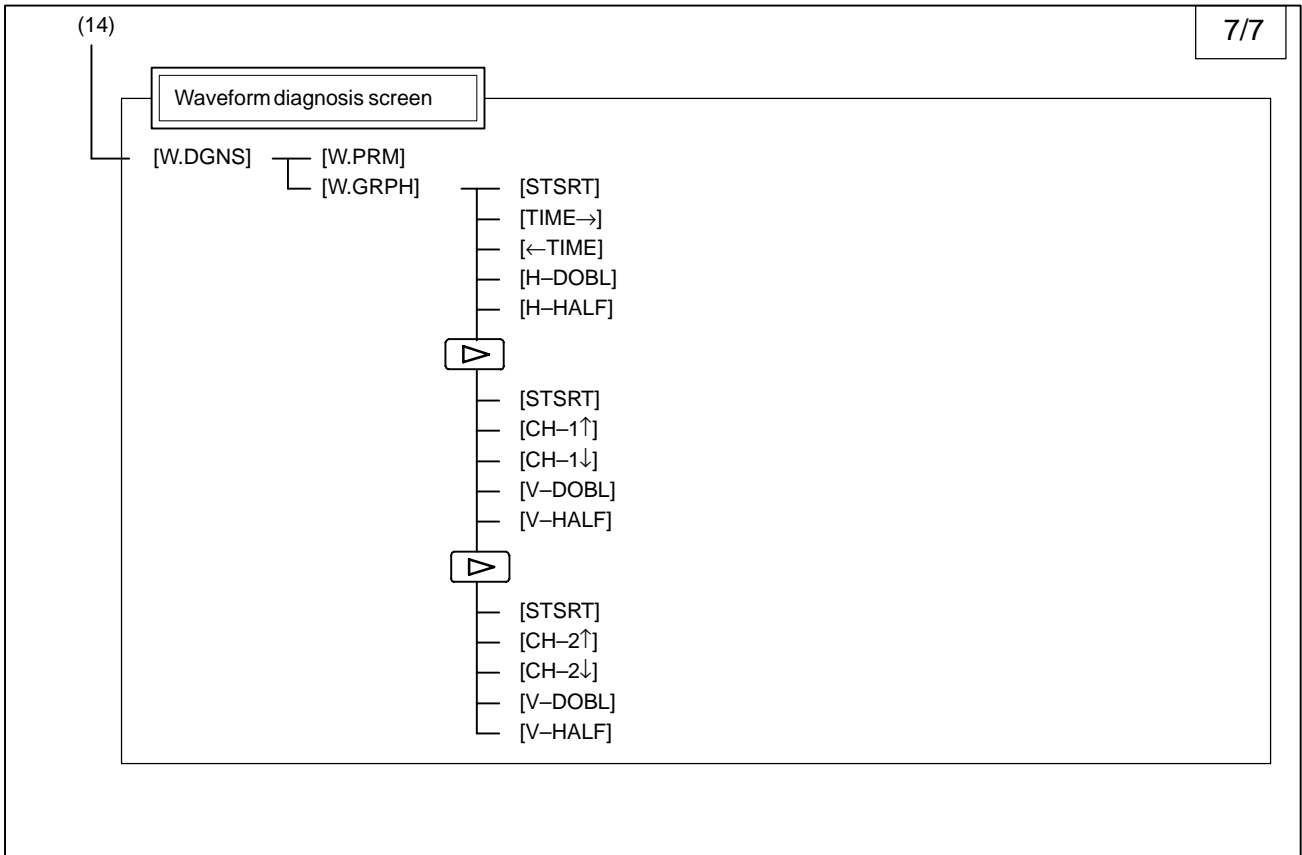

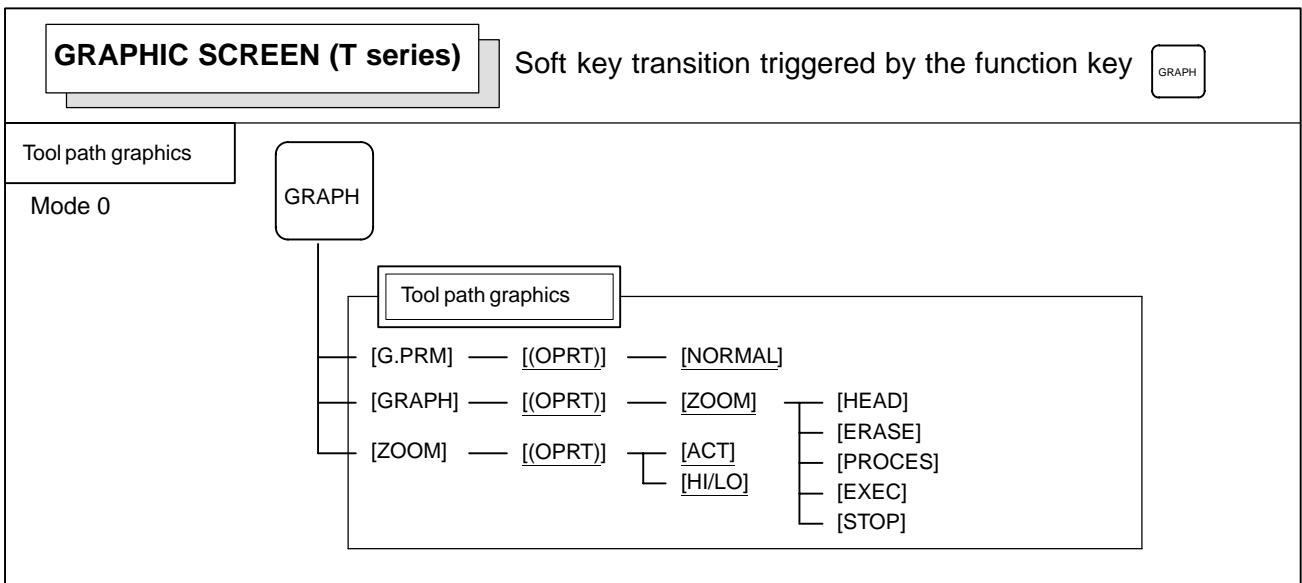
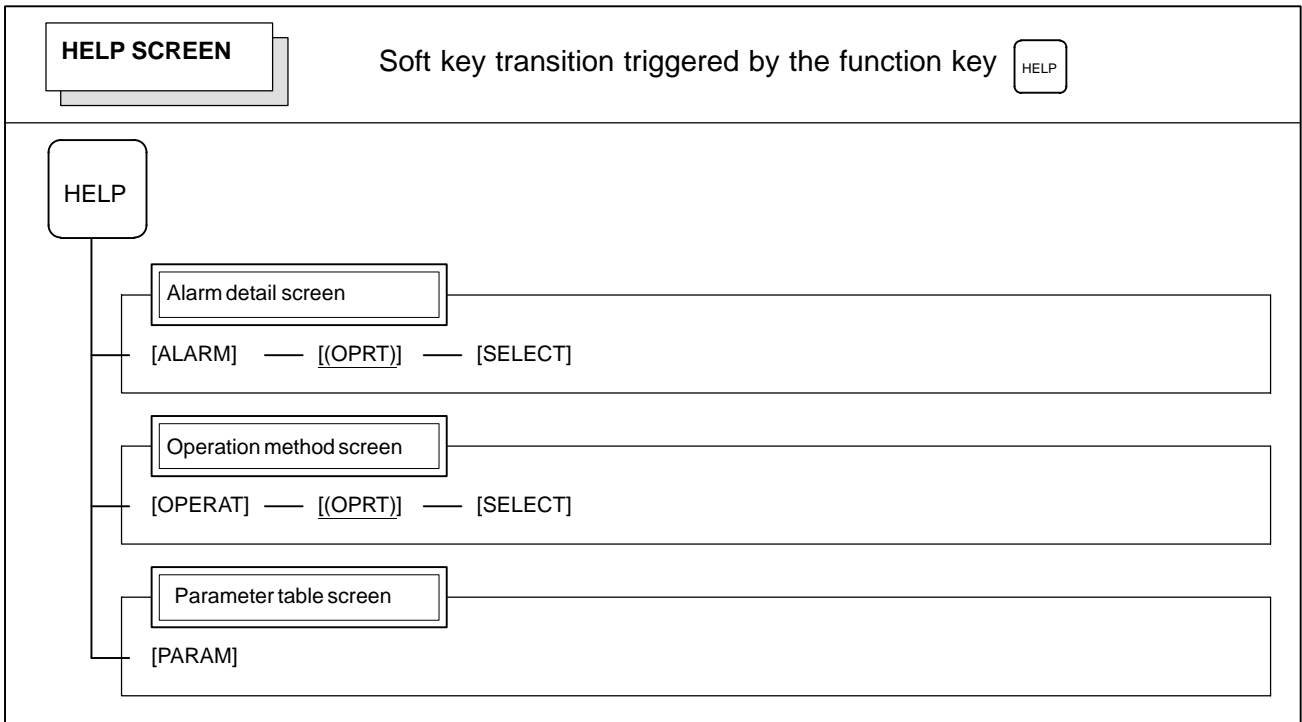

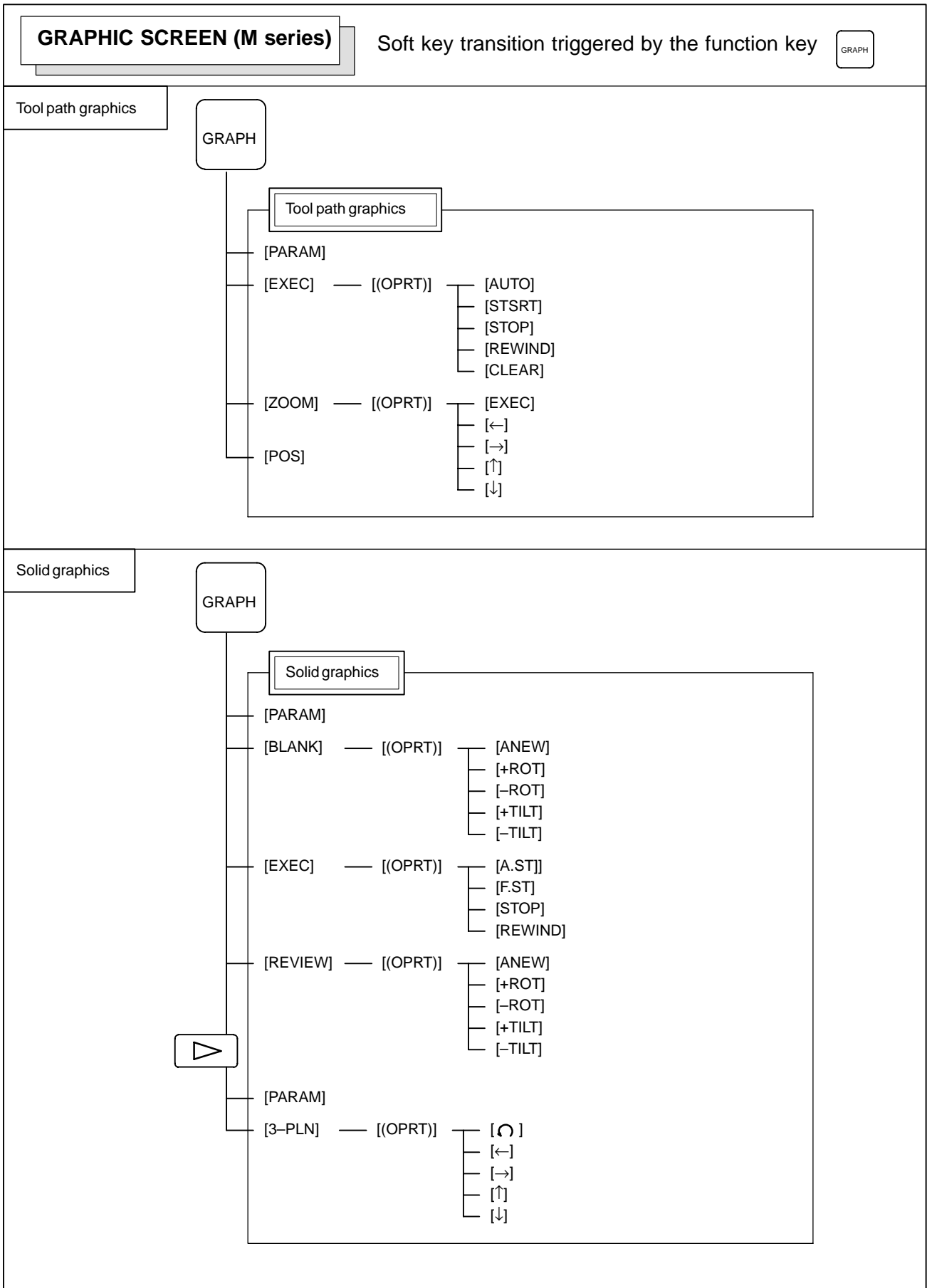

1.2 SCREEN DISPLAYED IMMEDIATELY AFTER POWER IS TURNED ON

1.2.1 Slot Status Display

Types of PCBs mounted on the slots are displayed.
If a hardware trouble or an incorrect mounting is found, this screen is displayed.

- Slot state screen

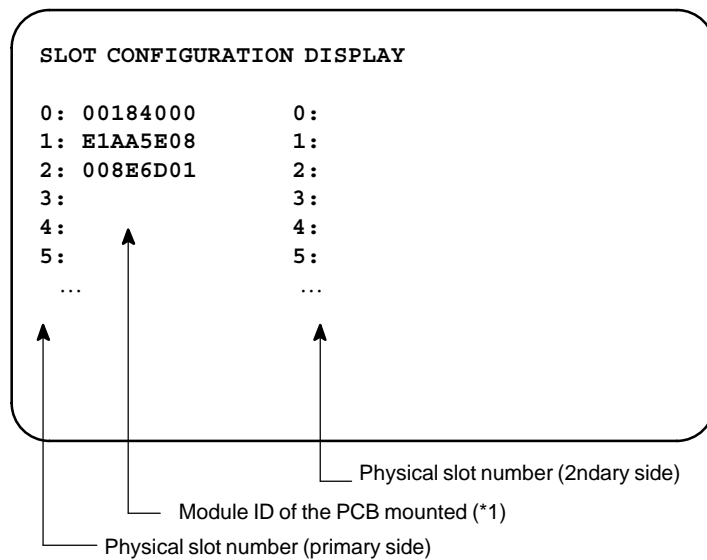

*1) Module ID of PCB

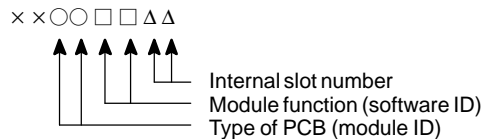

- Module ID

| ID | Name |
|----------|--|
| 18 | Series 0i-C main CPU board |
| 19 | Series 0i Mate-C main CPU board |
| 1A 1B | Series 0i-C main CPU board |
| 1C | Series 0i Mate-C main CPU board |
| 8E | Data server board, Fast Ethernet board |

NOTE

See page p-2 in "PREFACE" for information about the basic units.

- Software ID

40 : Main CPU
6D : Fast Ethernet, Data server

1.2.2 Setting Module Screen

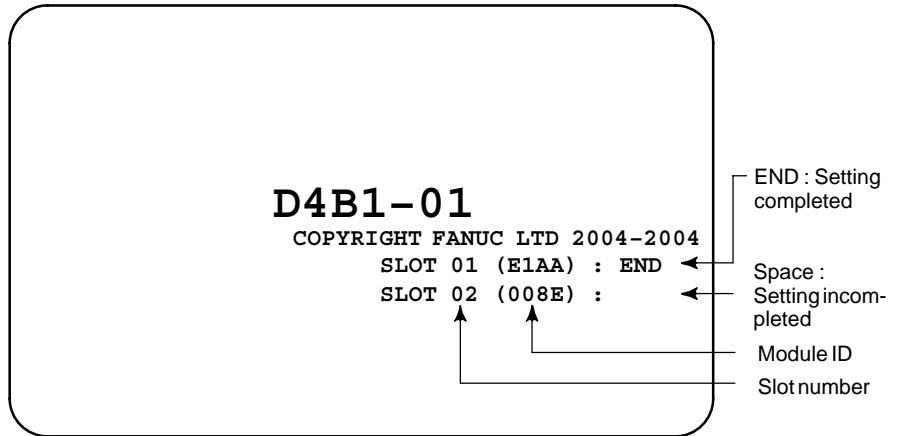

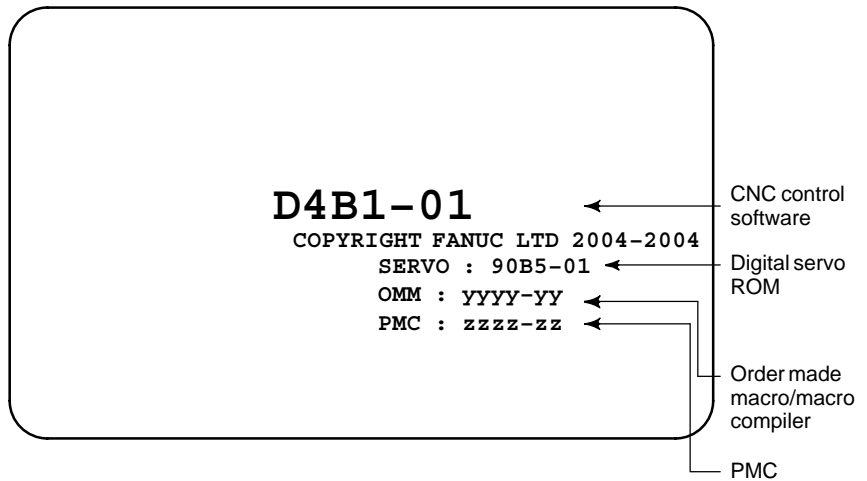

1.2.3 Configuration Display of Software



1.3 SYSTEM CONFIGURATION SCREEN

After the system has been installed correctly, you can find the PCBs installed and the softwares integrated on the system configuration screen.

1.3.1 Display Method

- (1) Press  key.
- (2) Press soft key [SYSTEM], then the system configuration screen is displayed.
- (3) The system configuration screen is composed of three screens and each of them can be selected by the page key  .

1.3.2 Configuration of PCBs

- Screen

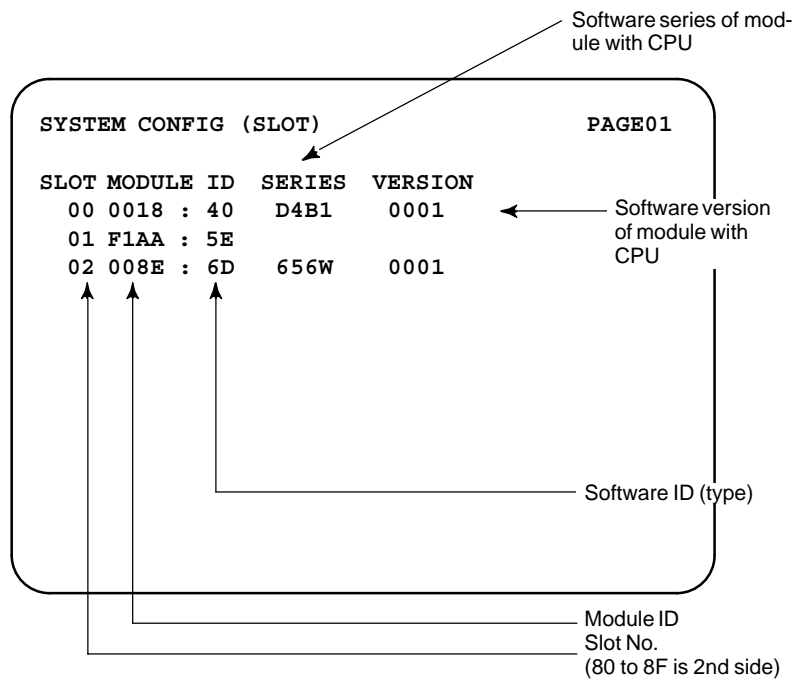

● **Module ID**

| ID | Name |
|----------|--|
| 18 | Series 0i-C main CPU board |
| 19 | Series 0i Mate-C main CPU board |
| 1A 1B | Series 0i-C main CPU board |
| 1C | Series 0i Mate-C main CPU board |
| 8E | Data server board, Fast Ethernet board |

NOTE

See page p-2 in “PREFACE” for information about the basic units.

● **Software ID**

40 : Main CPU
6D : Fast Ethernet, Data server

1.3.3 Software Configuration Screen

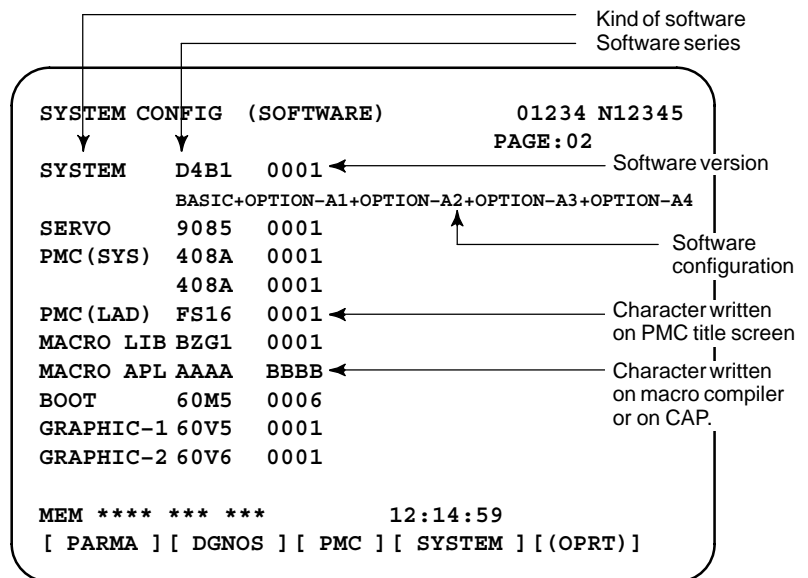

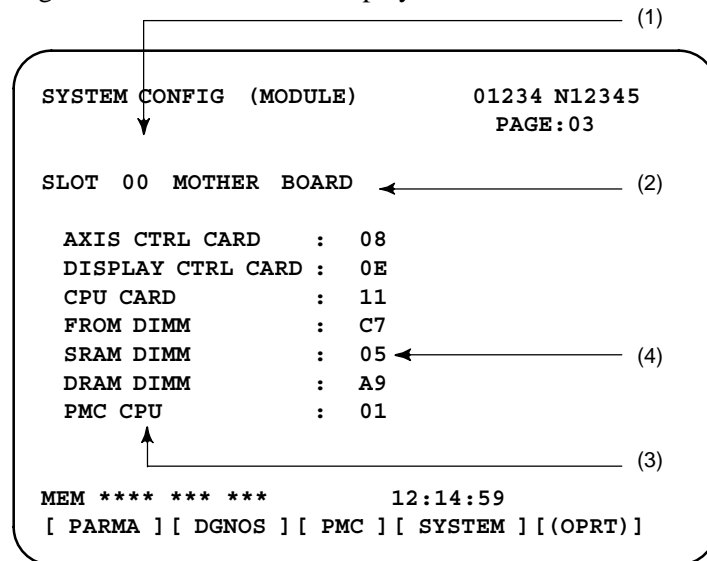

1.3.4 Module Configuration Screen

Configuration of the modules displayed on PCB.



Contents of display

- (1) Slot number (The number is corresponding to PCB configuration screen)
- (2) Type of PCB mounted
- (3) Name of card PCB or DIMM module
- (4) Hardware ID of mounted card PCB or DIMM module
Refer to “2.5.3 Printed Circuit Boards of the Control Unit” for correspondence with each hardware ID and drawing number.

Pressing the PAGE key   displays the system configuration screen of other PCBs.

1.3.5 ID Information Screen (α i Servo Information Screen/ α i Spindle Information Screen)

- α i series servo and α i series spindle
When the α i servo/ α i spindle system is connected, ID information owned by connected units (motor, amplifier, module, etc.) for α i servo/ α i spindle can be displayed on the CNC screen. See below for details.
 - α i servo information screen (Chapter 6 Digital Servo)
 - α i spindle information screen (Chapter 7 AC Spindle (Serial Spindle))

1.4 ALARM HISTORY SCREEN

1.4.1 Alarm History Screen



1.4.1.1 General

Alarms generated in the NC are recorded. The latest 50 alarms generated are recorded. The 50th and former alarms are deleted.

1.4.1.2 Screen display

(1) Press  key .

(2) Press soft key [**HISTORY**] and an alarm history screen is displayed.

(3) Other pages are displayed by  or  key.

```

ALARM HISTORY                                O1234 N12345

02/04/18 20:56:26
 506 OVERTRAVEL : +X
02/04/18 19:58:11
 000 TURN OFF POWER
02/04/18 19:52:45
 000 TURN OFF POWER
02/04/18 19:48:43
 300 APC ALARM  : X-AXIS ZERO RETURN REQUEST
02/04/18 18:10:10
 507 OVERTRAVEL : +B

[ ALARM ] [ MSG ] [ HISTORY ] [          ] [(OPRT)]

```

1.4.1.3 Clearing alarm history

(1) Press soft key [**(OPRT)**].

(2) Press soft key [**(CLEAR)**], then the alarm history is cleared.

1.4.1.4 Alarm display

When an external alarm (No. 1000 to 1999) or a macro alarm (No. 3000 to 3999) is output, the alarm history function can record both the alarm number and message if so specified in the following parameter. If recording of the message is not set or if no message is input, only an external alarm or macro alarm is displayed.

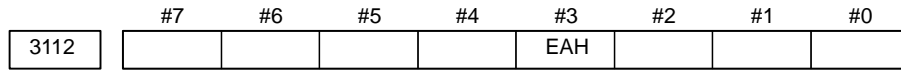

[Data type] Bit

#3 (EAH) The alarm history function:

- 0 : Does not record the messages output with external alarms or macro alarms.
- 1 : Records the messages output with external alarms or macro alarms.

1.4.2 System Alarm History

1.4.2.1 General

Up to three system alarms issued in the past are stored, and information about those alarms can be displayed on the system alarm history screen.

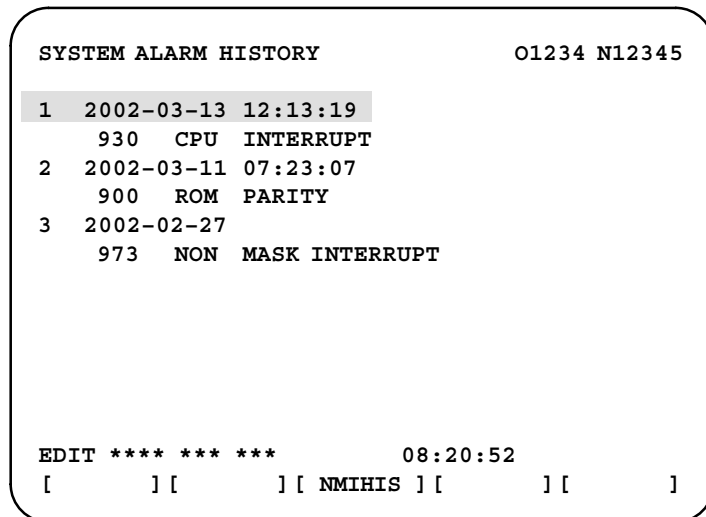

1.4.2.2 System alarm history screen (history list screen)

By setting bit 2 (NMH) of parameter No. 3103 to 1, information about up to three system alarms including the latest system alarm can be displayed. The latest system alarm information is displayed at the top of the list, and a lower item in the list indicates older system alarm information.

Procedure

- 1 Set bit 2 (NMH) of parameter No. 3103 to 1.
- 2 Press the function key <MESSAGE>.
- 3 Press the [NMIHIS] chapter selection soft key.

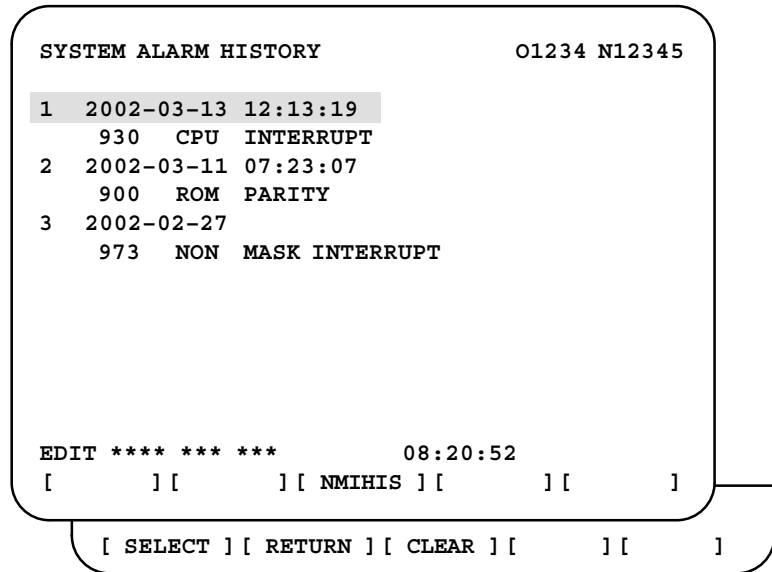

The following information is displayed:

1. System alarm occurrence date and time
2. System alarm number
3. System alarm message (No message is displayed for some system alarms.)

**[SELECT] soft key**

This soft key displays the details of a system alarm.

Procedure

- 1 Press the [(OPRT)] soft key on the system configuration screen.
- 2 By using the cursor keys  , move the cursor to the system alarm number whose details are to be displayed.
- 3 Press the [SELECT] soft key.
- 4 The details of the selected system alarm are displayed.

[CLEAR] soft key

This soft key clears all system alarm information stored.

When bit 4 (OPC) of parameter No. 3110 is set to 1, this soft key is displayed. When bit 4 (OPC) of parameter No. 3110 is set to 0, this soft key is not displayed.

Procedure

- 1 Set bit 4 (OPC) of parameter No. 3110 to 1.
- 2 Press the [(OPRT)] soft key on the system configuration screen.
- 3 Press the [CLEAR] soft key.
- 4 Information about all of the three system alarms stored is cleared.

[RETURN] soft key

Pressing the [RETURN] soft key while system alarm history screen (detail screen) is displayed returns the screen display to the system alarm list screen.

1.4.2.3 System alarm history screen (detail screen)

The system alarm history screen (detail screen) displays information items such as registers and stacks involved when a system alarm is issued.

The following items are displayed:

1. System alarm occurrence date and time
2. System alarm number
3. System alarm message (No message is displayed for some system alarms.)
4. System alarm occurrence series and edition
5. Number of display pages
6. General-purpose resistor, pointer index register, segment register, task register, LDT register, flag register, interrupt source, error code, error address
7. Contents of stacks (up to 32 stacks)
8. Contents of stacks of privilege level 3 (up to 48 stacks)
9. NMI information

You can switch among the information items 6 to 9 by the page keys



Pressing the [RETURN] soft key returns the screen display to the state alarm history list screen.

```

SYSTEM ALARM HISTORY                                01234 N12345

2  2002-03-11 07:23:07          D4B1-01(1/4)
   973 NON MASK INTERRUPT
EAX      EBX      ECX      EDX
00000000 00930063 000003E0 00000040
ESI      EDI      EBP      ESP
00000010 009404E0 0000FFB4 0000FFDC
SS  DS  ES  FS  GS  TR  LDTR
06D8 0338 0248 0440 0338 0628 0028
EFLAGS  VECT  ERRC  ERROR-ADDRESS
00003046 FFFF  0000  03E0:000009BC

EDIT **** * * * * *                08:20:52
[ SELECT ] [ RETURN ] [ CLEAR ] [      ] [      ]

```

(Detail display screen 1)

```

SYSTEM ALARM HISTORY                                01234 N12345

2  2002-03-11 07:23:07      D4B1-01(2/4)
   973 NON MASK INTERRUPT

STACK (PL0)
3646 0338 7CBA 0001 0958 FFF8 0068 0063
0346 0000 0000 02BC 08F8 52F1 2438 0338
0580 0440 0580 001F 03C0 0214 0780 0FFF
0000 0000 0000 0000 0000 0000 0000 0000

EDIT **** * * * * *                08:20:52
[ SELECT ] [ RETURN ] [ CLEAR ] [      ] [      ]
    
```

(Detail display screen 2)

```

SYSTEM ALARM HISTORY                                01234 N12345

2  2002-03-11 07:23:07      D4B1-01(3/4)
   973 NON MASK INTERRUPT
   STACK!(PL3)
SS:ESP3 =0804:00007C50
CS:EIP =1350:00001234
  1008 1408 0001 0002 0003 0004 1008 FFE4
  1008 3678 00FA 0024 0000 0000 0000 0000
  0000 0000 0000 0000 0000 0000 0000 0000
  0000 0000 0000 0000 0000 0000 0000 0000
  0000 0000 0000 0000 0000 0000 0000 0000
  0000 0000 0000 0000 0000 0000 0000 0000

EDIT **** * * * * *                08:20:52
[ SELECT ] [ RETURN ] [ CLEAR ] [      ] [      ]
    
```

(Detail display screen 3)

```

SYSTEM ALARM HISTORY                                01234 N12345

2  2002-03-11 07:23:07      D4B1-01(4/4)
   973 NON MASK INTERRUPT
NMIC
00000000 00000000 00000000 00000000
SVL
11111111 11111111
SVR
11111111 11111111 11111111 11111111
11111111 11111111 11111111 11111111
ADRS
007F0000

EDIT **** * * * * *                08:20:52
[ SELECT ] [ RETURN ] [ CLEAR ] [      ] [      ]
    
```

(Detail display screen 4)



CAUTION

In the case of an NMI on other than the main board, the registers of detail display screen 1, and the contents of detail display screen 2 and detail display screen 3 are displayed.

```

SYSTEM ALARM HISTORY                                01234 N12345

2  2002-03-11 07:23:07          D4B1-01(1/1)
    972 NMI OCCURRED IN OTHER MODULE

SLOT>  02          0080415F
        <1>          <2>

EDIT **** * * * * *                08:20:52
[ SELECT ] [ RETURN ] [ CLEAR ] [    ] [    ]
    
```

(Detail display screen 5)

<1> NMI occurrence slot number

<2> Message address set with the NMI occurrence slot (string address)

```

SYSTEM ALARM HISTORY                                01234 N12345

2  2002-03-11 07:23:07          D4B1-01(1/1)
    900 ROM PARITY

00000000      00000000
                <1>

EDIT **** * * * * *                08:20:52
[ SELECT ] [ RETURN ] [ CLEAR ] [    ] [    ]
    
```

(Detail display screen 6)

<1> ROM parity cause

- Basic ROM 2F(h)
(800000 to 97FFFF)
- Additional ROM 40(h)
(A00000 to A3FFFF)
- OMM ROM 80(h)
- Servo ROM 100(h)
- Built-in MMC ROM 200(h)
- Online Custom Screen 400(h)

1.4.2.4**Parameter**

| | | | | | | | | |
|------|----|----|----|----|----|-----|----|----|
| | #7 | #6 | #5 | #4 | #3 | #2 | #1 | #0 |
| 3103 | | | | | | NMH | | |

[Data type] Bit**NMH** The system alarm history screen is:

0 : Not displayed.

1 : Displayed.

| | | | | | | | | |
|------|----|----|----|-----|----|----|----|----|
| | #7 | #6 | #5 | #4 | #3 | #2 | #1 | #0 |
| 3110 | | | | OPC | | | | |

[Data type] Bit**OPC** On the operation history screen, the [CLEAR] soft key is:

0 : Not enabled.

1 : Enabled.

1.5 EXTERNAL OPERATOR MESSAGES RECORD

This function enables the saving of external operator messages as a record.



The record can be viewed on the external operator message history screen.

1.5.1 Screen Display

(1) Press the  function key.

(2) Press the rightmost soft key  .

(3) Press the **[MSGHIS]** soft key.

(4) To display the previous or subsequent screen, press the  or  key.

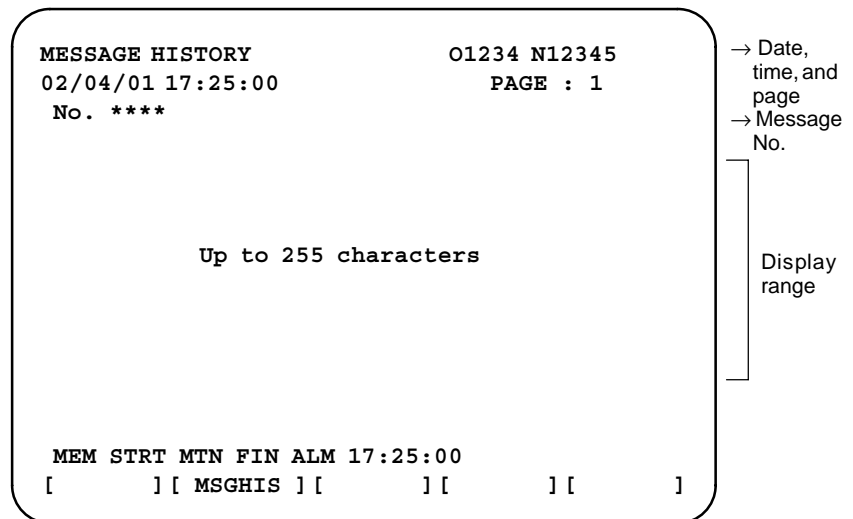

1.5.2 Deletion of External Operator Messages Record

(1) The recorded external operator message can be deleted by setting the MMC bit (bit 0 of parameter No. 3113) to 1.

Pressing the **[CLEAR]** soft key erases all the records of the external operator message.

(2) The MS1 and MS0 bits (bits 7 and 6 of parameter No. 3113) specify the number of records to be displayed on the external operator message history screen. When the bits are changed, all external operator message records retained up to that point are erased.

1.5.3 Parameter

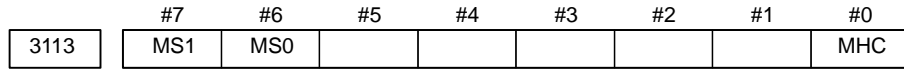

#0 (MHC) The records of an external operator message:
 0 : Cannot be erased.
 1 : Can be erased.

#6, #7 (MS0,MS1) These bits set the number of characters to be retained in each record of an external operator message, as well as the number of records, as shown in the following table:

| MS1 | MS0 | Number of characters in each record | Number of records |
|-----|-----|-------------------------------------|-------------------|
| 0 | 0 | 255 | 8 |
| 0 | 1 | 200 | 10 |
| 1 | 0 | 100 | 18 |
| 1 | 1 | 50 | 32 |

* An external operator message of up to 255 characters can be specified. Combining the MS1 bit and MS0 bit (bits 7 and 6 of parameter No. 3113) selects the number of records by limiting the number of characters to be retained as the record of an external operator message.

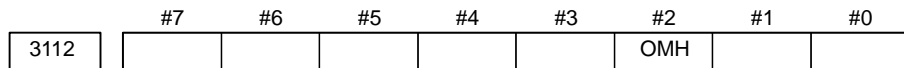

#2 (OMH) The external operator message history screen is:
 0 : Not displayed.
 1 : Displayed.

NOTE
 After setting this parameter, briefly turn the power off, then on again.

1.5.4 Notes

When the number of an external operator message is specified, the system starts updating the records of the specified message. The system continues to perform update until another external operator message is specified or until an instruction to delete the records of the external operator message is specified.

1.6 OPERATION HISTORY

This function displays the key and signal operations performed by the operator upon the occurrence of a fault or the output of an alarm, together with the corresponding alarms.

This function records the following data:

- (1) MDI key operations performed by the operator
- (2) Status changes (ON/OFF) of input and output signals (selected signals only)
- (3) Details of alarms
- (4) Time stamp (date and time)

1.6.1 Parameter Setting

| | | | | | | | | |
|------|-----|----|----|-----|----|----|----|----|
| | #7 | #6 | #5 | #4 | #3 | #2 | #1 | #0 |
| 3106 | OHS | | | OPH | | | | |

[Data type] Bit

OPH The operation history screen is:

0 : Not displayed.

1 : Displayed.

OHS The operation history is:

0 : Sampled.

1 : Not sampled.

| | |
|------|---|
| 3122 | Interval at which the clock time is recorded in the operation history |
|------|---|

[Data type] Word

[Units of data] Minutes

[Valid data range] 0 to 1439

The clock time is recorded to the operation history at specified intervals. If zero is set as the interval, ten minutes is assumed. The time is recorded only when data is recorded within the corresponding interval.

| | | | | | | | | |
|------|----|----|----|-----|----|----|----|----|
| | #7 | #6 | #5 | #4 | #3 | #2 | #1 | #0 |
| 3206 | | | | PHS | | | | |

[Data type] Bit

PHS Setting and display on the operation history signal selection screen and the parameters (No. 12801 through No. 128900) are:

0 : Not linked.

1 : Linked.

| | |
|-------|--|
| 12801 | Number of a signal symbol table for selecting an operation history signal (01) |
| 12802 | Number of a signal symbol table for selecting an operation history signal (02) |
| 12803 | Number of a signal symbol table for selecting an operation history signal (03) |
| 12804 | Number of a signal symbol table for selecting an operation history signal (04) |
| 12805 | Number of a signal symbol table for selecting an operation history signal (05) |
| 12806 | Number of a signal symbol table for selecting an operation history signal (06) |
| 12807 | Number of a signal symbol table for selecting an operation history signal (07) |
| 12808 | Number of a signal symbol table for selecting an operation history signal (08) |
| 12809 | Number of a signal symbol table for selecting an operation history signal (09) |
| 12810 | Number of a signal symbol table for selecting an operation history signal (10) |
| 12811 | Number of a signal symbol table for selecting an operation history signal (11) |
| 12812 | Number of a signal symbol table for selecting an operation history signal (12) |
| 12813 | Number of a signal symbol table for selecting an operation history signal (13) |
| 12814 | Number of a signal symbol table for selecting an operation history signal (14) |
| 12815 | Number of a signal symbol table for selecting an operation history signal (15) |
| 12816 | Number of a signal symbol table for selecting an operation history signal (16) |
| 12817 | Number of a signal symbol table for selecting an operation history signal (17) |
| 12818 | Number of a signal symbol table for selecting an operation history signal (18) |
| 12819 | Number of a signal symbol table for selecting an operation history signal (19) |
| 12820 | Number of a signal symbol table for selecting an operation history signal (20) |

[Data type] Byte

[Valid data range] 1 to 10

Set the number of a symbol table including a signal of which operation history is to be recorded for operation history channel (01) to (20) as follows:

| | | | | |
|---|---|----|----|------|
| 1 | : | G0 | to | G255 |
| 3 | : | F0 | to | F255 |
| 5 | : | Y0 | to | Y127 |
| 6 | : | X0 | to | X127 |

| | |
|-------|---|
| 12841 | Number of a signal selected as an operation history signal (01) |
| 12842 | Number of a signal selected as an operation history signal (02) |
| 12843 | Number of a signal selected as an operation history signal (03) |
| 12844 | Number of a signal selected as an operation history signal (04) |
| 12845 | Number of a signal selected as an operation history signal (05) |
| 12846 | Number of a signal selected as an operation history signal (06) |
| 12847 | Number of a signal selected as an operation history signal (07) |
| 12848 | Number of a signal selected as an operation history signal (08) |
| 12849 | Number of a signal selected as an operation history signal (09) |
| 12850 | Number of a signal selected as an operation history signal (10) |
| 12851 | Number of a signal selected as an operation history signal (11) |
| 12852 | Number of a signal selected as an operation history signal (12) |
| 12853 | Number of a signal selected as an operation history signal (13) |
| 12854 | Number of a signal selected as an operation history signal (14) |
| 12855 | Number of a signal selected as an operation history signal (15) |
| 12856 | Number of a signal selected as an operation history signal (16) |
| 12857 | Number of a signal selected as an operation history signal (17) |
| 12858 | Number of a signal selected as an operation history signal (18) |
| 12859 | Number of a signal selected as an operation history signal (19) |
| 12860 | Number of a signal selected as an operation history signal (20) |

[Data type] Word

[Valid data range] 0 to 255 (Decimal number)

Set the number of a signal of which operation history is to be recorded for operation history channel (01) to (20) with a value between 0 and 255.

| | #7 | #6 | #5 | #4 | #3 | #2 | #1 | #0 |
|-------|--|-----|-----|-----|-----|-----|-----|-----|
| 12881 | RB7 | RB6 | RB5 | RB4 | RB3 | RB2 | RB1 | RB0 |
| | History record bit settings for an operation history signal (01) | | | | | | | |
| 12882 | RB7 | RB6 | RB5 | RB4 | RB3 | RB2 | RB1 | RB0 |
| | History record bit settings for an operation history signal (02) | | | | | | | |
| 12883 | RB7 | RB6 | RB5 | RB4 | RB3 | RB2 | RB1 | RB0 |
| | History record bit settings for an operation history signal (03) | | | | | | | |
| 12884 | RB7 | RB6 | RB5 | RB4 | RB3 | RB2 | RB1 | RB0 |
| | History record bit settings for an operation history signal (04) | | | | | | | |
| 12885 | RB7 | RB6 | RB5 | RB4 | RB3 | RB2 | RB1 | RB0 |
| | History record bit settings for an operation history signal (05) | | | | | | | |
| 12886 | RB7 | RB6 | RB5 | RB4 | RB3 | RB2 | RB1 | RB0 |
| | History record bit settings for an operation history signal (06) | | | | | | | |
| 12887 | RB7 | RB6 | RB5 | RB4 | RB3 | RB2 | RB1 | RB0 |
| | History record bit settings for an operation history signal (07) | | | | | | | |
| 12888 | RB7 | RB6 | RB5 | RB4 | RB3 | RB2 | RB1 | RB0 |
| | History record bit settings for an operation history signal (08) | | | | | | | |
| 12889 | RB7 | RB6 | RB5 | RB4 | RB3 | RB2 | RB1 | RB0 |
| | History record bit settings for an operation history signal (09) | | | | | | | |
| 12890 | RB7 | RB6 | RB5 | RB4 | RB3 | RB2 | RB1 | RB0 |
| | History record bit settings for an operation history signal (10) | | | | | | | |
| 12891 | RB7 | RB6 | RB5 | RB4 | RB3 | RB2 | RB1 | RB0 |
| | History record bit settings for an operation history signal (11) | | | | | | | |
| 12892 | RB7 | RB6 | RB5 | RB4 | RB3 | RB2 | RB1 | RB0 |
| | History record bit settings for an operation history signal (12) | | | | | | | |
| 12893 | RB7 | RB6 | RB5 | RB4 | RB3 | RB2 | RB1 | RB0 |
| | History record bit settings for an operation history signal (13) | | | | | | | |
| 12894 | RB7 | RB6 | RB5 | RB4 | RB3 | RB2 | RB1 | RB0 |
| | History record bit settings for an operation history signal (14) | | | | | | | |
| 12895 | RB7 | RB6 | RB5 | RB4 | RB3 | RB2 | RB1 | RB0 |
| | History record bit settings for an operation history signal (15) | | | | | | | |

| | #7 | #6 | #5 | #4 | #3 | #2 | #1 | #0 |
|-------|-----|-----|-----|-----|-----|-----|-----|-----|
| 12896 | RB7 | RB6 | RB5 | RB4 | RB3 | RB2 | RB1 | RB0 |

History record bit settings for an operation history signal (16)

| | #7 | #6 | #5 | #4 | #3 | #2 | #1 | #0 |
|-------|-----|-----|-----|-----|-----|-----|-----|-----|
| 12897 | RB7 | RB6 | RB5 | RB4 | RB3 | RB2 | RB1 | RB0 |

History record bit settings for an operation history signal (17)

| | #7 | #6 | #5 | #4 | #3 | #2 | #1 | #0 |
|-------|-----|-----|-----|-----|-----|-----|-----|-----|
| 12898 | RB7 | RB6 | RB5 | RB4 | RB3 | RB2 | RB1 | RB0 |

History record bit settings for an operation history signal (18)

| | #7 | #6 | #5 | #4 | #3 | #2 | #1 | #0 |
|-------|-----|-----|-----|-----|-----|-----|-----|-----|
| 12899 | RB7 | RB6 | RB5 | RB4 | RB3 | RB2 | RB1 | RB0 |

History record bit settings for an operation history signal (19)

| | #7 | #6 | #5 | #4 | #3 | #2 | #1 | #0 |
|-------|-----|-----|-----|-----|-----|-----|-----|-----|
| 12900 | RB7 | RB6 | RB5 | RB4 | RB3 | RB2 | RB1 | RB0 |

History record bit settings for an operation history signal (20)

[Data type] Bit

RB7 to RB0 For the signal set in channel (01) to (20), of which operation history is to be recorded, the history of each bit is:

0 : Not recorded. (The history of this bit is not recorded.)

1 : Recorded. (The history of this bit is recorded.)

1.6.2 Screen Display

• Displaying the operation history

- (1) Press the  function key.
- (2) Press the continue menu key [▷]. The [OPEHIS] (OPERATION HISTORY) soft key are displayed.
- (3) Press the [OPEHIS] soft key twice. The operation history screen is displayed.

| OPERATION HISTORY | | | O1234 N12345 |
|-------------------|-------------|-------------|--------------|
| | | | Page : 123 |
| No. DATA | No. DATA | No. DATA | |
| 01 01/06/03 | 11 F0000.7↑ | 21 F0001.0↓ | |
| 02 08:40:00 | 12 F0000.5↑ | 22 <POS> | |
| 03 <DELETE> | 13 F0001.0↑ | 23 <PROG> | |
| 04 F0000.6↑ | 14 F0000.5↓ | 24 <RESET> | |
| 05 MEM | 15 P/S0010 | 25 EDIT | |
| 06 G0009.0↑ | 16 02/06/03 | 26 0 | |
| 07 G0009.1↑ | 17 09:27:49 | 27 1 | |
| 08 G0009.2↑ | 18 <PROG> | 28 2 | |
| 09 ST↑ | 19 <RESET> | 29 3 | |
| 10 ST↓ | 20 F0000.7↓ | 30 4 | |
| EDIT **** * * * * | | | 08:20:52 |
| [TOP] | [BOTTOM] | [] | [PG.SRH] |

On the operation history screen, the soft keys are configured as shown below:

```

⇒ [▷] [PARAM] [DGNOS] [PMC] [SYSTEM] [(OPE)] [▷]
                                     ↓push
[◁] [W.DGNS] [ ] [ ] [OPEHIS] [(OPE)] [▷]
                                     ↓push
[◁] [OPEHIS] [SG-SEL] [ ] [ ] [(OPE)] [▷]
                                     ↓push
[◁] [ TOP ] [BOTTOM] [ ] [ ] [ PG.SRH ] [▷]

```

- (4) To display the next part of the operation history, press the page down key . The next page is displayed.

To display the interface between two pages, press cursor key  or



. The screen is scrolled by one row. On a 14-inch CRT screen, pressing the cursor key scrolls the screen by half a page.

These soft keys can also be used:

- 1) Pressing the [TOP] soft key displays the first page (oldest data).
- 2) Pressing the [BOTTOM] soft key displays the last page (latest data).
- 3) Pressing the [PG.SRH] soft key displays a specified page.

Example) By entering 50 then pressing the [PG.SRH] key, page 50 is displayed.

Data displayed on the operation history screen

(1) MDI keys

Address and numeric keys are displayed after a single space.

Soft keys are displayed in square brackets ([]).

Other keys (RESET/INPUT, for example) are displayed in angle brackets (<>).

A key pressed at power-on is displayed in reverse video.

1) Function key: <POS>, <PROG>, <OFFSET>, etc.

2) Address/numeric key: A to Z, 0 to 9, ; (EOB), +, -, (, etc.

3) Page/cursor key: <PAGE↑>, <CUR↓>, <CUR←>

4) Soft key: [SF1], [SF2], etc.

5) Other key: <RESET>, <CAN>, etc.

6) Key pressed at power-on: **<RESET>**

(2) Input and output signals

General signals are displayed in the following format:

G 0 0 0 0 . 7 ↑

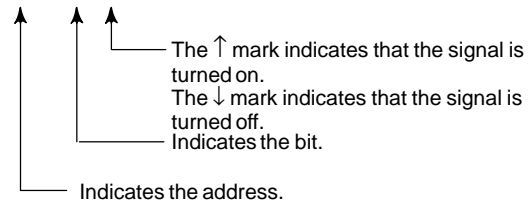

Some signals are indicated by their symbol names.

SBK ↑ (Indicates that the single block switch is turned on.)

Mode selection signals and rapid traverse override signals are displayed as indicated below:

| Input signal | | | | | Name displayed |
|--------------|-----|-----|-----|------|----------------|
| MD1 | ND2 | MD4 | REF | DNC1 | |
| 0 | 0 | 0 | 0 | 0 | MDI |
| 1 | 0 | 0 | 0 | 0 | MEM |
| 1 | 0 | 0 | 0 | 1 | RMT |
| 0 | 1 | 0 | 0 | 0 | NOMODE |
| 1 | 1 | 0 | 0 | 0 | EDT |
| 0 | 0 | 1 | 0 | 0 | H/INC |
| 1 | 0 | 1 | 0 | 0 | JOG |
| 1 | 0 | 1 | 1 | 0 | REF |
| 0 | 1 | 1 | 0 | 0 | TJOG |
| 1 | 1 | 1 | 0 | 0 | THND |

| Input signal | | Name displayed |
|--------------|------|----------------|
| ROV1 | ROV2 | |
| 0 | 0 | R100% |
| 1 | 0 | R50% |
| 0 | 1 | R25% |
| 1 | 1 | RF0% |

(3) NC alarms

NC alarms are displayed in reverse video.

P/S alarms, system alarms, and external alarms are displayed together with their numbers.

For other types of alarms, only the alarm type is displayed. (No details are displayed.)

(4) Time stamp (date and time)

The following time data (date and time) is recorded:

- 1) Date and time of power-on
- 2) Date and time of power-off
- 3) Date and time when an NC alarm occurs
- 4) The clock time is recorded at predetermined intervals, together with each new calendar day.

- 1) The power-on time is displayed as shown below:
 02/01/20 ===== Year/Month/Day
 09:15:30 ===== Hour:Minute:Second
- 2) The power-off time and the time when an NC alarm occurred are displayed in reverse video.

02/01/20 ===== Year/Month/Day
 09:15:30 ===== Hour:Minute:Second

If a system alarm occurs, the date and time are not recorded.

- 3) At predetermined intervals, the clock time is displayed in reverse video. Set the interval in minutes in parameter No. 3122. If zero is set, the time is stamped at ten-minute intervals.

09:15:30 ===== Hour:Minute:Second

Each new calendar day is displayed in reverse video.

02/01/20 ===== Year/Month/Day

 **CAUTION**

- 1 The clock time is recorded for a specified interval only when data is stored within that interval.
- 2 If a system alarm is issued, the system alarm occurrence time is used for power-off display.

● **Input signal or output signal to be recorded in the operation history**



- (1) Press the  function key.
- (2) Press the continuous menu key [▷]. The [OPEHIS] (operation history) soft key is displayed.
- (3) Press the [OPEHIS] soft key, then press the [SG-SEL] soft key. The operation history signal selection screen is displayed.

| OP_HIS SIGNAL SELECT | | | O1000 N02000 | | |
|-------------------------------------|--------|----------|--------------|--------|----------|
| No. | ADDRES | SIGNAL | No. | ADDRES | SIGNAL |
| 01 | X0000 | 00001000 | 11 | G0000 | 00000001 |
| 02 | X0004 | 10000000 | 12 | G0004 | 00000011 |
| 03 | X0008 | 00001100 | 13 | G0008 | 00000111 |
| 04 | X0009 | 00111000 | 14 | G0003 | 00001111 |
| 05 | X0012 | 00001111 | 15 | G0043 | 01100000 |
| 06 | Y0000 | 01000000 | 16 | | ***** |
| 07 | Y0004 | 00110000 | 17 | | ***** |
| 08 | Y0007 | 00011100 | 18 | | ***** |
| 09 | Y0008 | 00011100 | 19 | | ***** |
| 10 | Y0010 | 00011100 | 20 | | ***** |
| > | | | | | |
| EDIT **** * * * * 00:00:00 | | | | | |
| [OPEHIS] [SG-SEL] [] [] [(OPE)] | | | | | |

1.6.3 Setting the Input Signal or Output Signal to be Recorded in the Operation History

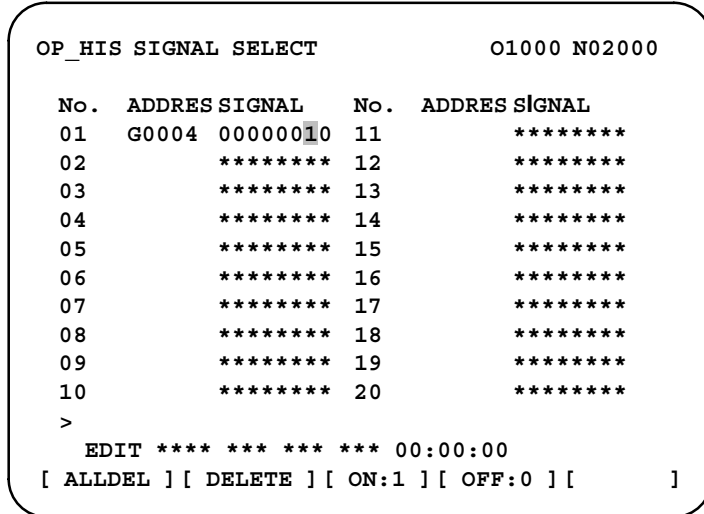
- (1) On the operation history signal selection screen, press the **[OPRT]** soft key.





- (2) Press the cursor key  or  to position the cursor to a desired position.

- (3) Key in a signal type (X, G, F, or Y) and an address, then press the  key.

Example) G0004 

Signal address G0004 is set in the ADDRESS column. The corresponding position in the SIGNAL column is initialized to 00000000.

- (4) Select the bit to be recorded.
To select all bits of the specified signal address, press the **[ON:1]** soft key while the cursor is positioned to **00000000**.
To select a particular bit, position the cursor to that bit by pressing the cursor key  or , then press the **[ON:1]** soft key. To cancel a selection made by pressing the **[ON:1]** soft key or to cancel a previously selected signal, press the **[OFF:0]** soft key.
- (5) Up to 20 addresses can be specified by means of this signal selection. These addresses need not always be specified at consecutive positions, starting from No.1.
- (6) Pressing the **[ALLDEL]** and **[EXEC]** soft keys deletes all data. If the **[ALLDEL]** key is pressed by mistake, it can be cancelled by pressing the **[CAN]** key.
- (7) To delete a selected signal address, position the cursor to the corresponding position then press the **[DELETE]** and **[EXEC]** soft keys. In the SIGNAL column, asterisks ********* are displayed in place of the deleted data. In the ADDRESS column, the corresponding position is cleared.
If the **[DELET]** key is pressed by mistake, it can be cancelled by pressing the **[CAN]** key.
- (8) Pressing the return menu key **[<]** causes the **[OPEHIS]** (OPE) soft key to be displayed again.

● **Parameter-based setting**

By setting bit 4 (PHS) of parameter No. 3206, setting and display on the operation history signal selection screen can be linked with parameter No. 12801 through No. 12900. By this linking, setting information related to input and output signals subject to operation history processing can be input and output in the same way as ordinary parameters.

● **Input signals and output signals to be recorded in the history**

NOTE

- 1 A cross (×) indicates that a signal will not be recorded. Also, any signal for which an address is not specified will not be recorded, either.
- 2 A circle (○) indicates that a signal can be recorded.
- 3 A signal indicated by its symbol name will also be displayed by its symbol name.

1. M/T addresses

MT→PMC

| | #7 | #6 | #5 | #4 | #3 | #2 | #1 | #0 |
|------|----|----|----|----|----|----|----|----|
| X000 | ○ | ○ | ○ | ○ | ○ | ○ | ○ | ○ |
| to | | | | | | | | |
| X127 | ○ | ○ | ○ | ○ | ○ | ○ | ○ | ○ |

PMC→CNC

| | #7 | #6 | #5 | #4 | #3 | #2 | #1 | #0 |
|------|-------|------|-------|------|------|------|------|------|
| G000 | ○ | ○ | ○ | ○ | ○ | ○ | ○ | ○ |
| to | | | | | | | | |
| G003 | ○ | ○ | ○ | ○ | ○ | ○ | ○ | ○ |
| G004 | ○ | ○ | ○ | ○ | FIN | ○ | ○ | ○ |
| G005 | ○ | ○ | ○ | ○ | TFIN | SFIN | ○ | MFIN |
| G006 | ○ | ○ | ○ | ○ | ○ | *ABS | ○ | SRN |
| G007 | RLSOT | EXLM | *FLUP | ○ | ○ | ST | STLK | ○ |
| G008 | ERS | RRW | *SP | *ESP | ○ | ○ | ○ | *IT |
| G009 | ○ | ○ | ○ | ○ | ○ | ○ | ○ | ○ |
| to | | | | | | | | |
| G013 | ○ | ○ | ○ | ○ | ○ | ○ | ○ | ○ |
| G014 | ○ | ○ | ○ | ○ | ○ | ○ | ○ | ○ |
| G015 | ○ | ○ | ○ | ○ | ○ | ○ | ○ | ○ |
| to | | | | | | | | |
| G018 | ○ | ○ | ○ | ○ | ○ | ○ | ○ | ○ |
| G019 | RT | ○ | ○ | ○ | ○ | ○ | ○ | ○ |

| | #7 | #6 | #5 | #4 | #3 | #2 | #1 | #0 |
|------|------|------|------|------|------|------|------|------|
| G020 | ○ | ○ | ○ | ○ | ○ | ○ | ○ | ○ |
| to | | | | | | | | |
| G042 | ○ | ○ | ○ | ○ | ○ | ○ | ○ | ○ |
| G043 | ○ | × | ○ | × | × | ○ | ○ | ○ |
| G044 | ○ | ○ | ○ | ○ | ○ | ○ | MLK | BDT1 |
| G045 | BDT9 | BDT8 | BDT7 | BDT6 | BDT5 | BDT4 | BDT3 | BDT2 |
| G046 | DRN | KEY4 | KEY3 | KEY2 | KEY1 | ○ | SBK | ○ |
| G047 | ○ | ○ | ○ | ○ | ○ | ○ | ○ | ○ |
| to | | | | | | | | |
| G060 | ○ | ○ | ○ | ○ | ○ | ○ | ○ | ○ |
| G061 | ○ | ○ | ○ | ○ | ○ | ○ | ○ | RGTA |
| G062 | ○ | ○ | ○ | ○ | ○ | ○ | ○ | ○ |
| to | | | | | | | | |
| G099 | ○ | ○ | ○ | ○ | ○ | ○ | ○ | ○ |
| G100 | +J8 | +J7 | +J6 | +J5 | +J4 | +J3 | +J2 | +J1 |
| G101 | ○ | ○ | ○ | ○ | ○ | ○ | ○ | ○ |
| G102 | -J8 | -J7 | -J6 | -J5 | -J4 | -J3 | -J2 | -J1 |
| G103 | ○ | ○ | ○ | ○ | ○ | ○ | ○ | ○ |
| to | | | | | | | | |
| G105 | ○ | ○ | ○ | ○ | ○ | ○ | ○ | ○ |
| G106 | MI8 | MI7 | MI6 | MI5 | MI4 | MI3 | MI2 | MI1 |
| G107 | ○ | ○ | ○ | ○ | ○ | ○ | ○ | ○ |
| G108 | MLK8 | MLK7 | MLK6 | MLK5 | MLK4 | MLK3 | MLK2 | MLK1 |
| G109 | ○ | ○ | ○ | ○ | ○ | ○ | ○ | ○ |
| G110 | +LM8 | +LM7 | +LM6 | +LM5 | +LM4 | +LM3 | +LM2 | +LM1 |
| G111 | ○ | ○ | ○ | ○ | ○ | ○ | ○ | ○ |
| G112 | -LM8 | -LM7 | -LM6 | -LM5 | -LM4 | -LM3 | -LM2 | -LM1 |
| G113 | ○ | ○ | ○ | ○ | ○ | ○ | ○ | ○ |
| G114 | *+L8 | *+L7 | *+L6 | *+L5 | *+L4 | *+L3 | *+L2 | *+L1 |

| | #7 | #6 | #5 | #4 | #3 | #2 | #1 | #0 |
|------|--------------------------|--------------------------|--------------------------|--------------------------|--------------------------|--------------------------|--------------------------|--------------------------|
| G115 | <input type="checkbox"/> | <input type="checkbox"/> | <input type="checkbox"/> | <input type="checkbox"/> | <input type="checkbox"/> | <input type="checkbox"/> | <input type="checkbox"/> | <input type="checkbox"/> |
| G116 | *-L8 | *-L7 | *-L6 | *-L5 | *-L4 | *-L3 | *-L2 | *-L1 |
| G117 | <input type="checkbox"/> | <input type="checkbox"/> | <input type="checkbox"/> | <input type="checkbox"/> | <input type="checkbox"/> | <input type="checkbox"/> | <input type="checkbox"/> | <input type="checkbox"/> |
| G118 | *+ED8 | *+ED7 | *+ED6 | *+ED5 | *+ED4 | *+ED3 | *+ED2 | *+ED1 |
| G119 | <input type="checkbox"/> | <input type="checkbox"/> | <input type="checkbox"/> | <input type="checkbox"/> | <input type="checkbox"/> | <input type="checkbox"/> | <input type="checkbox"/> | <input type="checkbox"/> |
| G120 | *-ED8 | *-ED7 | *-ED6 | *-ED5 | *-ED4 | *-ED3 | *-ED2 | *-ED1 |
| G121 | <input type="checkbox"/> | <input type="checkbox"/> | <input type="checkbox"/> | <input type="checkbox"/> | <input type="checkbox"/> | <input type="checkbox"/> | <input type="checkbox"/> | <input type="checkbox"/> |
| to | | | | | | | | |
| G125 | <input type="checkbox"/> | <input type="checkbox"/> | <input type="checkbox"/> | <input type="checkbox"/> | <input type="checkbox"/> | <input type="checkbox"/> | <input type="checkbox"/> | <input type="checkbox"/> |
| G126 | SVF8 | SVF7 | SVF6 | SVF5 | SVF4 | SVF3 | SVF2 | SVF1 |
| G127 | <input type="checkbox"/> | <input type="checkbox"/> | <input type="checkbox"/> | <input type="checkbox"/> | <input type="checkbox"/> | <input type="checkbox"/> | <input type="checkbox"/> | <input type="checkbox"/> |
| to | | | | | | | | |
| G129 | <input type="checkbox"/> | <input type="checkbox"/> | <input type="checkbox"/> | <input type="checkbox"/> | <input type="checkbox"/> | <input type="checkbox"/> | <input type="checkbox"/> | <input type="checkbox"/> |
| G130 | *IT8 | *IT7 | *IT6 | *IT5 | *IT4 | *IT3 | *IT2 | *IT1 |
| G131 | <input type="checkbox"/> | <input type="checkbox"/> | <input type="checkbox"/> | <input type="checkbox"/> | <input type="checkbox"/> | <input type="checkbox"/> | <input type="checkbox"/> | <input type="checkbox"/> |
| G132 | <input type="checkbox"/> | <input type="checkbox"/> | <input type="checkbox"/> | <input type="checkbox"/> | +MIT4 | +MIT3 | +MIT2 | +MIT1 |
| G133 | <input type="checkbox"/> | <input type="checkbox"/> | <input type="checkbox"/> | <input type="checkbox"/> | <input type="checkbox"/> | <input type="checkbox"/> | <input type="checkbox"/> | <input type="checkbox"/> |
| G134 | <input type="checkbox"/> | <input type="checkbox"/> | <input type="checkbox"/> | <input type="checkbox"/> | -MIT4 | -MIT3 | -MIT2 | -MIT1 |
| G135 | <input type="checkbox"/> | <input type="checkbox"/> | <input type="checkbox"/> | <input type="checkbox"/> | <input type="checkbox"/> | <input type="checkbox"/> | <input type="checkbox"/> | <input type="checkbox"/> |
| to | | | | | | | | |
| G255 | <input type="checkbox"/> | <input type="checkbox"/> | <input type="checkbox"/> | <input type="checkbox"/> | <input type="checkbox"/> | <input type="checkbox"/> | <input type="checkbox"/> | <input type="checkbox"/> |

PMC→MT

| | #7 | #6 | #5 | #4 | #3 | #2 | #1 | #0 |
|------|--------------------------|--------------------------|--------------------------|--------------------------|--------------------------|--------------------------|--------------------------|--------------------------|
| Y000 | <input type="checkbox"/> | <input type="checkbox"/> | <input type="checkbox"/> | <input type="checkbox"/> | <input type="checkbox"/> | <input type="checkbox"/> | <input type="checkbox"/> | <input type="checkbox"/> |
| to | | | | | | | | |
| Y127 | <input type="checkbox"/> | <input type="checkbox"/> | <input type="checkbox"/> | <input type="checkbox"/> | <input type="checkbox"/> | <input type="checkbox"/> | <input type="checkbox"/> | <input type="checkbox"/> |

CNC→PMC

| | #7 | #6 | #5 | #4 | #3 | #2 | #1 | #0 |
|------|--------------------------|--------------------------|--------------------------|--------------------------|--------------------------|--------------------------|--------------------------|--------------------------|
| F000 | <input type="checkbox"/> | <input type="checkbox"/> | <input type="checkbox"/> | <input type="checkbox"/> | <input type="checkbox"/> | <input type="checkbox"/> | <input type="checkbox"/> | <input type="checkbox"/> |
| to | | | | | | | | |
| F255 | <input type="checkbox"/> | <input type="checkbox"/> | <input type="checkbox"/> | <input type="checkbox"/> | <input type="checkbox"/> | <input type="checkbox"/> | <input type="checkbox"/> | <input type="checkbox"/> |

1.6.4 Inputting and Outputting the Operation History Data

Recorded data can be output to an input/output unit connected via a reader/punch interface. An output record can be input from the input/output unit.

Set the input/output unit to be used in setting parameters No. 0020 and 0100 to 0135.

To output the data, set a code in the ISO bit of a setting parameter (bit 1 of parameter No. 0020).

• Output

(1) Select EDIT mode.

(2) Press the  key, then select the operation history display screen.

(3) Press the soft keys [(OPRT)], , [PUNCH], and [EXEC] in this order.

The data output to the FANUC Floppy Cassette or FANUC FA Card is stored under file name OPERATION HISTORY.

• Input

(1) Select EDIT mode.

(2) Press the  key, then select the operation history display screen.

(3) Press the soft keys [(OPRT)], , [READ], and [EXEC] in this order.

• Output data format

1. MDI/soft key
2. Signal
3. Alarm
4. For extension (date or time)

The header and recorded operation data are output, in this order. The operation history data is divided into four parts by identifier words. Data other than the identifier words depends on the type.

| T(identifier word) | |
|--------------------|--------------------------------|
| T0 | : Header |
| T50 | : MDI/soft key |
| T51 | : Signal |
| T52 | : Alarm |
| T53 | : For extension (date or time) |

1) Header

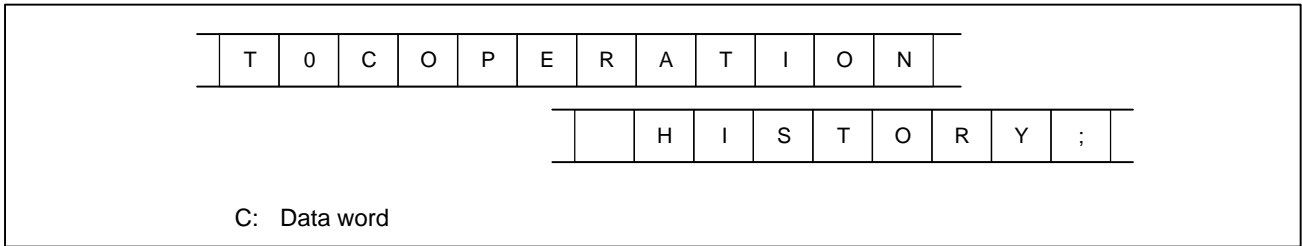

2) MDI/soft key

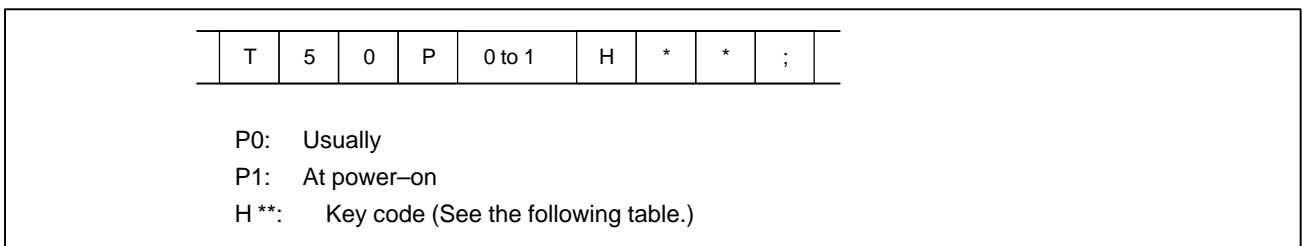

3) Signal

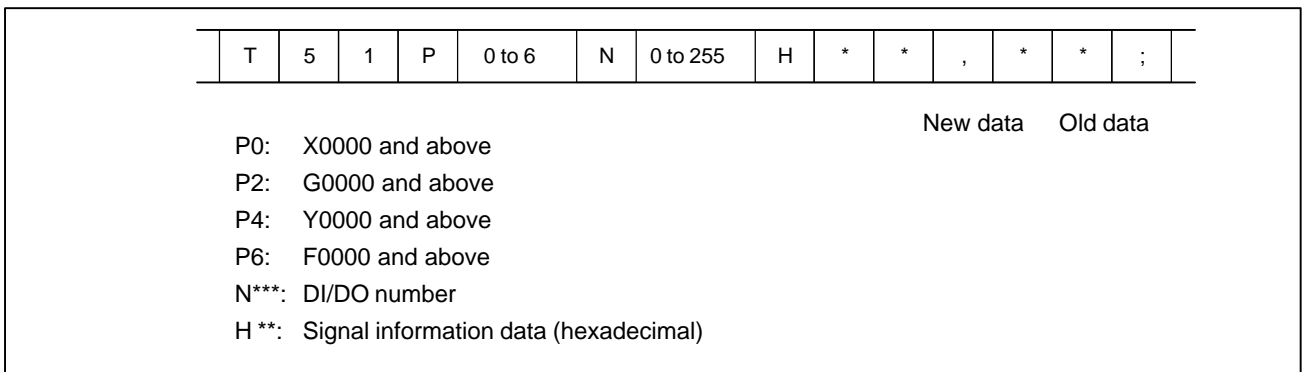

4) Alarm

| | | | | | | | | | | |
|---|---|---|---|---------|---|---|---|---|---|---|
| T | 5 | 2 | P | 0 to 10 | N | * | * | * | * | : |
|---|---|---|---|---------|---|---|---|---|---|---|

- P0: P/S No. 100
- P1: P/S No. 000
- P2: P/S No. 101
- P3: P/S No. 0001 to 254
- P4: Overtravel alarm
- P5: Overheat alarm
- P6: Servo alarm
- P7: System alarm
- P8: APC alarm
- P9: Spindle alarm
- P10: P/S alarm No. 5000 to 5999
- P15: External alarm
- N****: Alarm number (for P/S alarm, system alarm, and external alarm only)

5) For extension (date or time)

Date

| | | | | | | | | | | | | | | | | |
|---|---|---|---|--------|---|---|---|---|---|---|---|---|---|---|---|---|
| T | 5 | 3 | P | 0 to 1 | E | 0 | D | * | * | * | * | * | * | * | * | : |
|---|---|---|---|--------|---|---|---|---|---|---|---|---|---|---|---|---|

Time

| | | | | | | | | | | | | | | |
|---|---|---|---|--------|---|---|---|---|---|---|---|---|---|---|
| T | 5 | 3 | P | 0 to 1 | E | 1 | D | * | * | * | * | * | * | : |
|---|---|---|---|--------|---|---|---|---|---|---|---|---|---|---|

- P0: Usually
- P1: At power-on
- E0: Date
- E1: Time
- D*..*: Data Example) June 29, 2002



| | | | | | | | | |
|---|---|---|---|---|---|---|---|---|
| D | 2 | 0 | 0 | 2 | 0 | 6 | 2 | 9 |
|---|---|---|---|---|---|---|---|---|

Key codes (MDI/soft key)
(00H to 7FH)

| | 0 | 1 | 2 | 3 | 4 | 5 | 6 | 7 |
|---|------------|---|-------|---|---|---|---|---|
| 0 | | | Space | 0 | @ | P | | |
| 1 | | | ! | 1 | A | Q | | |
| 2 | | | " | 2 | B | R | | |
| 3 | | | # | 3 | C | S | | |
| 4 | | | \$ | 4 | D | T | | |
| 5 | | | % | 5 | E | U | | |
| 6 | | | & | 6 | F | V | | |
| 7 | | | ' | 7 | G | W | | |
| 8 | | | (| 8 | H | X | | |
| 9 | | |) | 9 | I | Y | | |
| A | ; (EOB) | | * | : | J | Z | | |
| B | | | + | | K | [| | |
| C | | | ' | < | L | ¥ | | |
| D | | | - | = | M |] | | |
| E | | | . | > | N | | | |
| F | | | / | ? | O | - | | |

(80H to FFH)

| | 8 | 9 | A | B | C | D | E | F |
|---|---------|----------|---|---|---|---|------------------------|------|
| 0 | | Reset * | | | | | | F0 * |
| 1 | | MMC * | | | | | | F1 * |
| 2 | | CNC * | | | | | | F2 * |
| 3 | | | | | | | | F3 * |
| 4 | Shift | Insert * | | | | | | F4 * |
| 5 | | Delete * | | | | | | F5 * |
| 6 | CAN | Alter * | | | | | | F6 * |
| 7 | | | | | | | | F7 * |
| 8 | Cur→ * | Input * | | | | | POS * | F8 * |
| 9 | Cur← * | | | | | | PROG * | F9 * |
| A | Cur↓ * | Help * | | | | | OFFSET SETTING * | |
| B | Cur↑ * | | | | | | SYSTEM * | |
| C | | | | | | | MESSAGE * | |
| D | | | | | | | CUSTOM GRAPH *1* | |
| E | Page↓ * | | | | | | CUSTOM * | FR * |
| F | Page↑ * | | | | | | Fapt * | FL * |

*1: On the small-sized keyboard, ED corresponds to the  key. On a standard keyboard, ED corresponds to the  key and EE to the  key.

*: Command key

1.6.5 Notes

- (1) While the operation history screen is displayed, no information can be recorded to the history.
- (2) An input signal having an on/off width of up to 16 msec is not recorded in the history. Some signals are not recorded in the history.
- (3) Once the storage becomes full, old data is deleted, starting from the oldest record. Up to about 8000 key information items can be recorded.
- (4) The recorded data is retained even after the power is turned off. A memory all clear operation, however, erases the recorded data.
- (5) The operation history function cannot execute sampling when the OHS bit (bit 7 of parameter No. 3106) is set to 1.
- (6) Set the date and time on the setting screen.
- (7) The time needed to input and output 6000 operation records at a rate of 4800 baud is as follows:
Output: About 5 minutes
Input: About 2 minutes and 30 seconds
This file corresponds to a paper tape of about 180 m in length.

1.7 HELP FUNCTION

1.7.1 General

The help function displays alarm information, operation method and a table of contents for parameters. This function is used as a handbook.

1.7.2 Display Method

- Display of help screen

Press  key on any screen other than PMC screen, then a help screen appears.
(However, it is not available when PMC screen/CUSTOM screen is displaying)

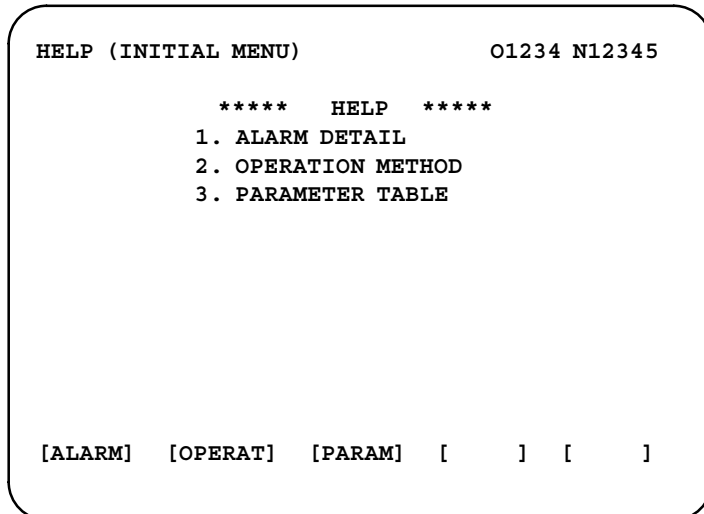

- Help for alarm

(1) When an alarm is generated, press soft key **[ALARM]**, then a help message of the alarm is displayed.

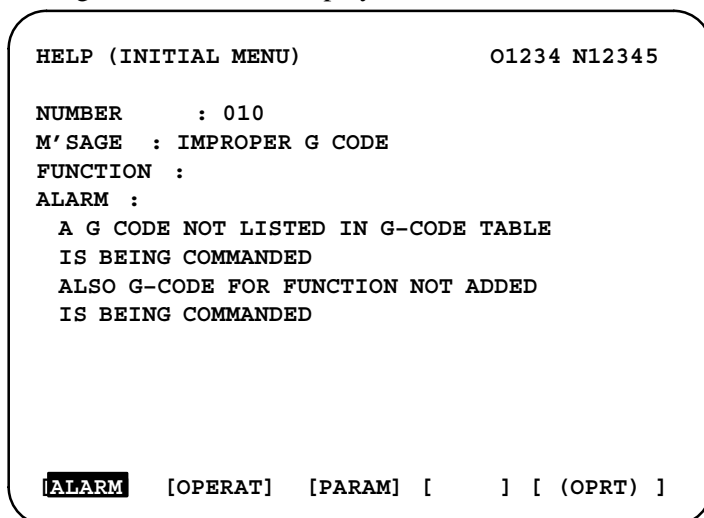

(2) Pressing soft key **[OPERAT]**, (alarm No.), and soft key **[SELECT]** in this order, a help message corresponding to the input alarm number is displayed.

● **Help for operation**

(1) Press **[(OPRT)]**, then a menu for operation method is displayed.

```



HELP (OPERATION METHOD)                O1234 N12345

1. PROGRAM EDIT
2. SEARCH
3. RESET
4. DATA INPUT WITH MDI
5. DATA INPUT WITH TAPE
6. OUTPUT
7. INPUT WITH FANUC CASSETTE
8. OUTPUT WITH FANUC CASSETTE
9. MEMORY CLEAR

[ALARM] [OPREPRAT] [PARAM] [ ] [(OPRT)]

```

(2) Press **[(OPRT)]**, (an item number) and soft key **[SELECT]**, then an operation method of the item is displayed.

Pressing PAGE key  or  displays another pages.

```

HELP (OPERATION METHOD)                O1234 N12345
<<1.PROGRAM EDIT>>                    1/4 ← Current
DELETE ALL PROGRAMS                    page/ Total
MODE :EDIT                             page
SCREEN :PROGRAM
OPR  :(0-9999) - (DELETE)

DELETE ONE PROGRAM
MODE : EDIT
SCREEN : PROGRAM
OPR  :(0+PROGRAM NUMBER) - <DELETE>



[ ] [ ] [ ] [ ] [SELECT]

```

● **Parameter table**

Press soft key **[PARAM]**, then a parameter table is displayed.

| | | |
|--|--------------|--------------------------|
| HELP (PARAMETER TABLE) | O1234 N12345 | |
| | 1/4 ← | Current page/ Total page |
| • SETTING | (NO. 0000~) | |
| • READER/PUNCHER INTERFACE | (NO. 0100~) | |
| • AXIS CONTROL/SETTING UNIT | (NO. 1000~) | |
| • COORDINATE SYSTEM | (NO. 1200~) | |
| • STROKE LIMIT | (NO. 1300~) | |
| • FEED RATE | (NO. 1400~) | |
| • ACCEL/DECELERATION CTRL | (NO. 1600~) | |
| • SERVO RELATED | (NO. 1800~) | |
| • DI/DO | (NO. 3000~) | |
| [ALARM] [OPERAT] [PARAM] [] [SELECT] | | |

Another screen can be selected by the PAGE key  or .

1.8 DISPLAYING DIAGNOSTIC PAGE

1.8.1 Displaying Diagnostic Page

(1) Press  key.

(2) Press soft key [DGNOS], then a diagnostic screen is displayed.

1.8.2 Contents Displayed

- **Causes when the machine does not travel in spite of giving a command**

| | |
|------------------------------------|---|
| 000 WAITING FOR FIN SIGNAL | An auxiliary function is being executed. |
| 001 MOTION | Travel command of cycle operation is being executed. |
| 002 DWELL | DWELL Dwell is being executed. |
| 003 IN-POSITION CHECK | In-position check is being done. |
| 004 FEEDRATE OVERRIDE 0% | Feedrate override is 0%. |
| 005 INTERLOCK/START LOCK | Interlock or start lock is input. |
| 006 SPINDLE SPEED ARRIVAL CHECK | Waiting for spindle speed arrival signal. |
| 010 PUNCHING | Data is being output through reader/puncher interface. |
| 011 READING | Data is being input through reader/puncher interface. |
| 012 WAITING FOR (UN) CLAMP | Waiting for the end of index table indexing |
| 013 JOG FEEDRATE OVERRIDE 0% | Manual feedrate override is 0%. |
| 014 WAITING FOR RESET, ESP,RRW OFF | NC is in reset state. |
| 015 EXTERNAL PROGRAM NUMBER SEARCH | External Program Number Search External program number search is being done |
| 016 BACKGROUND ACTIVE | Background is being used. |

● Cause of the cycle start LED turned off

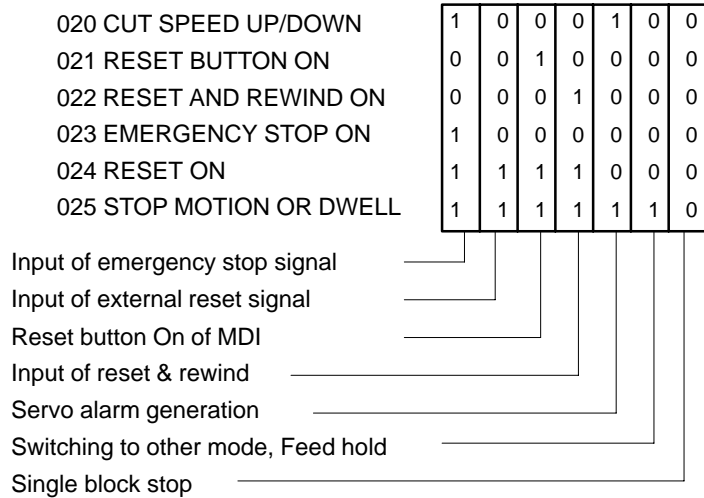

● State of TH alarm

030 CHARACTER NUMBER TH ALARM Position of the character that caused TH alarm. The position is counted from the head.

031 TH DATA Data of the character that caused TH alarm.

● Screen hardcopy status

| | #7 | #6 | #5 | #4 | #3 | #2 | #1 | #0 |
|-----|-----|----|----|-------|-------|-------|-------|-------|
| DGN | 035 | | | HCRE3 | HCRE2 | HCRE1 | Hcab3 | hcend |

- #4(HCRE3): Memory card writing failure (P/S5214)
- #3(HCRE2): Memory card exclusive right acquisition failure (P/S5213)
- #2(HCRE1): Hardcopy parameter setting error (P/S5212)
- #1(Hcab3): Hardcopy interrupt request acceptance
- #0(hcend): Hardcopy normal end

| | | | |
|-----|-----|--|--|
| DGN | 040 | | } Not used in the FANUC Series 0i/0i Mate-MODEL C. |
| | to | | |
| DGN | 046 | | |

● Details of serial pulse coder

| | #7 | #6 | #5 | #4 | #3 | #2 | #1 | #0 | |
|-----|-----|-----|----|-----|-----|-----|-----|-----|-----|
| DGN | 200 | OVL | LV | OVC | HCA | HVA | DCA | FBA | OFA |

- #7(OVL): Overload alarm
- #6(LV): Insufficient voltage alarm
- #5(OVC): Over current alarm
- #4(HCA): Abnormal current alarm
- #3(HVA): Overvoltage alarm
- #2(DCA): Discharge alarm
- #1(FBA): Disconnection alarm
- #0(OFA): Overflow alarm

| | | | | | | | | | |
|---------------------|-----|-----|----|----|-----|----|----|----|--|
| DGN | 201 | #7 | #6 | #5 | #4 | #3 | #2 | #1 | #0 |
| | | ALD | | | EXP | | | | |
| | | ↓ | | | ↓ | | | | |
| Overload alarm | 0 | – | – | – | | | | | Amplifier overheat |
| | 1 | – | – | – | | | | | Motor overheat |
| Disconnection alarm | 1 | – | – | 0 | | | | | Built-in pulse coder (hand) |
| | 1 | – | – | 1 | | | | | Disconnection of separated type pulse coder (hard) |
| | 0 | – | – | 0 | | | | | Disconnection of pulse coder (software) |

| | | | | | | | | | |
|-----|-----|----|-----|-----|-----|-----|-----|-----|-----|
| DGN | 202 | #7 | #6 | #5 | #4 | #3 | #2 | #1 | #0 |
| | | | CSA | BLA | PHA | RCA | BZA | CKA | SPH |

- #6(CSA): Hardware of serial pulse coder is abnormal
- #5(BLA): Battery voltage is low (warning)
- #4(PHA): Serial pulse coder or feedback cable is erroneous.
Counting of feedback cable is erroneous.
- #3(RCA): Serial pulse coder is faulty.
Counting of feedback cable is erroneous.
- #2(BZA): Battery voltage became 0.
Replace the battery and set the reference position.
- #1(CKA): Serial pulse coder is faulty.
Internal block stopped.
- #0(SPH): Serial pulse coder or feedback cable is faulty.
Counting of feedback cable is erroneous.

| | | | | | | | | | |
|-----|-----|-----|-----|-----|-----|----|----|----|----|
| DGN | 203 | #7 | #6 | #5 | #4 | #3 | #2 | #1 | #0 |
| | | DTE | CRC | STB | PRM | | | | |

- #7(DTE): Communication failure of serial pulse coder.
There is no response for communication.
- #6(CRC): Communication failure of serial pulse coder.
Transferred data is erroneous.
- #5(STB): Communication failure of serial pulse coder.
Transferred data is erroneous.
- #4(PRM): The alarm is detected by the servo, the values specified in the parameter is not correct.

| | | | | | | | | | |
|-----|-----|----|-----|-----|-----|-----|----|----|----|
| DGN | 204 | #7 | #6 | #5 | #4 | #3 | #2 | #1 | #0 |
| | | | OFS | MCC | LDA | PMS | | | |

- #6(OFS): Abnormal current value result of A/D conversion of digital
- #5(MCC): Contacts of MCC of servo amplifier is melted.
- #4(LDA): Serial pulse coder LED is abnormal
- #3(PMS): Feedback is not correct due to faulty serial pulse coder C or feedback cable.

● **Details of separate serial pulse coder alarms**

| | | | | | | | | | |
|-----|-----|-----|-----|-----|-----|-----|-----|-----|-----|
| | | #7 | #6 | #5 | #4 | #3 | #2 | #1 | #0 |
| DGN | 205 | OHA | LDA | BLA | PHA | CMA | BZA | PMA | SPH |

- #7(OHA): Overheat occurred in the separate pulse coder.
- #6(LDA): An LED error occurred in the separate pulse coder.
- #5(BLA): A low battery voltage occurred in the separate pulse coder.
- #4(PHA): A phase data error occurred in the separate linear scale.
- #3(CMA): A count error occurred in the separate pulse coder.
- #2(BZA): The battery voltage for the separate pulse coder is zero.
- #1(PMA): A pulse error occurred in the separate pulse coder.
- #0(SPH): A soft phase data error occurred in the separate pulse coder.

| | | | | | | | | | |
|-----|-----|-----|-----|-----|----|----|----|----|----|
| | | #7 | #6 | #5 | #4 | #3 | #2 | #1 | #0 |
| DGN | 206 | DTE | CRC | STB | | | | | |

- #7(DTE): A data error occurred in the separate pulse coder.
- #6(CRC): A CRC error occurred in the separate pulse coder.
- #5(STB): A stop bit error occurred in the separate pulse coder.

● **Details of invalid servo parameter alarms (on the CNC side)**

If servo alarm No. 417 is generated and bit 4 of diagnosis No. 203 is 0, indicates the cause.
 If bit 4 of diagnosis No. 203 is 1, refer to diagnosis No. 352.

| | | | | | | | | | |
|-----|-----|----|-----|----|-----|-----|-----|----|-----|
| | | #7 | #6 | #5 | #4 | #3 | #2 | #1 | #0 |
| DGN | 280 | | AXS | | DIR | PLS | PLC | | MOT |

- #0(MOT): The motor type specified in parameter No. 2020 falls outside the predetermined range.
- #2(PLC): The number of velocity feedback pulses per motor revolution, specified in parameter No. 2023, is zero or less. The value is invalid.
- #3(PLS): The number of position feedback pulses per motor revolution, specified in parameter No. 2024, is zero or less. The value is invalid.
- #4(DIR): The wrong direction of rotation for the motor is specified in parameter No. 2022 (the value is other than 111 or -111).
- #6(AXS): In parameter No. 1023 (servo axis number), a value that falls outside the range of 1 to the number of controlled axes is specified. (For example, 4 is specified instead of 3.) Alternatively, the values specified in the parameter are not consecutive.

● **Position error amount**

| | | |
|-----|-----|---|
| DGN | 300 | Position error of an axis in detection unit |
|-----|-----|---|

$$\text{Position error} = \frac{\text{Feed rate [mm/min]}}{60 \times \text{servo loop gain [1/sec]}} \times \frac{1}{\text{Detection unit}}$$

- **Machine position**

DGN

- **Reference position shift function**

DGN

[Data type] Two-word axis

[Units of data] 0.001 mm (metric output), 0.0001 inch (inch output)

[Valid data range] -99999999 to 99999999

- **Position deviation with fine acceleration/ deceleration enabled**

DGN

[Data type] Two-word axis

[Unit of data] Detection unit

[Valid data range] -99999999 to 99999999

- **Reference counter**

DGN

[Data type] Two-word axis

[Unit of data] Detection unit

[Valid data range] -99999999 to 99999999

- **Displacement detection**

DGN

[Data type] Two-word axis

[Unit of data] Detection unit

[Valid data range] -99999999 to 99999999

If displacement detection is enabled, the feedback data between the Z phases of different axes is represented in the detection unit.

● **Machine coordinates of angular axis/orthogonal axis**

| | | |
|-----|-----|--|
| DGN | 306 | Machine coordinates of a slant axis in the Cartesian coordinate system |
| DGN | 307 | Machine coordinates of an orthogonal axis in the Cartesian coordinate system |

[Data type] Two-word

[Unit of data]

| Increment system | IS-A | IS-B | IS-C | Unit |
|------------------|-------|-------|-------|------|
| Metric input | 0.01 | 0.01 | 0.01 | mm |
| Inch input | 0.001 | 0.001 | 0.001 | inch |
| Rotation axis | 0.01 | 0.01 | 0.01 | deg |

[Valid data range] -99999999 to 99999999

These parameters are updated only when bit 0 (AAC) of parameter No. 8200 is set to 1, and any of the parameters below is set to 1:

- Bit 0 (AOT) of parameter No. 8201
- Bit 1 (AO2) of parameter No. 8201
- Bit 2 (AO3) of parameter No. 8201
- Bit 3 (QSA) of parameter No. 5009 (T series only)
- The interference check option is selected.

● **Motor temperature information**

| | | |
|-----|-----|-------------------------|
| DGN | 308 | Servo motor temperature |
|-----|-----|-------------------------|

[Data type] Byte axis

[Unit of data] °C

[Valid data range] 0 to 255

The αi servo motor coil temperature is indicated.

When the temperature reaches 140°C, an alarm about motor overheat is issued.

| | | |
|-----|-----|-------------------------|
| DGN | 309 | Pulse coder temperature |
|-----|-----|-------------------------|

[Data type] Byte axis

[Unit of data] °C

[Valid data range] 0 to 255

The temperature of the pulse coder printed circuit board is indicated.

When the temperature reaches 100°C (85°C for the atmosphere temperature in the pulse coder), an alarm about motor overheat is issued.

NOTE

- 1 The temperature data must fall within the following ranges.
 50°C to 160°C ± 5°C
 160°C to 180°C ± 10°C
- 2 The temperature at which an overheat alarm is issued has a maximum error of 5°C.
- 3 Information on axes other than the α i servo axis is not indicated. (Indicated by "0°C.")

● **Cause of the APZ bit (bit 4 of parameter 1815) brought to 0**

With reference to the diagnosis below, you can determine the cause why the reference position return completion parameter was brought to 0.

| | | | | | | | | | |
|-----|-----|----|-----|-----|-----|-----|-----|-----|-----|
| | | #7 | #6 | #5 | #4 | #3 | #2 | #1 | #0 |
| DGN | 310 | | DTH | ALP | NOF | BZ2 | BZ1 | PR2 | PR1 |

- #0(PR1): The setting of the following parameters has been changed: Parameters 1821, 1850, 1860, 1861.
- #1(PR2): The setting of the ATS bit (bit 1 of parameter No. 8302) has been changed.
- #2(BZ1): The detected APC battery voltage is 0 V (Inductosyn).
- #3(BZ2): The detected APC battery voltage is 0 V (separate position detector).
- #4(NOF): The Inductosyn output no offset data.
- #5(ALP): Before the α pulse coder detects a full single rotation, reference position establishment by parameters was attempted.
- #6(DTH): A controlled axis detach signal/parameter was input.

| | | | | | | | | | |
|-----|-----|----|-----|-----|-----|-----|-----|-----|-----|
| | | #7 | #6 | #5 | #4 | #3 | #2 | #1 | #0 |
| DGN | 311 | | DUA | XBZ | GSG | AL4 | AL3 | AL2 | AL1 |

- #0(AL1): An APC alarm was issued.
- #2(AL3): The detected APC battery voltage is 0 V (serial pulse coder).
- #3(AL4): An abnormal rotation speed (RCAL) was detected.
- #4(GSG): The G202 signal was brought from 0 to 1.
- #1(AL2): A disconnection was detected.
- #6(DUA): While the dual position feedback function was being used, the difference in error between the semi-closed loop side and the closed loop side became too large.
- #5(XBZ): The detected APC battery voltage is 0 V (serial separate position detector).

● **FSSB status**

| | | | | | | | | | |
|-----|-----|-----|----|----|-----|-----|-----|-----|-----|
| | | #7 | #6 | #5 | #4 | #3 | #2 | #1 | #0 |
| DGN | 320 | CFE | | | ERP | OPN | RDY | OPP | CLS |

Indicates the internal status of the FSSBC.

- #0(CLS): Closed.
- #1(OPP): Running OPEN protocol.
- #2(RDY): Open and ready.
- #3(OPN): Open.
- #4(ERP): Running ERROR protocol.
- #7(CFE): Encountered configuration error.
(The actual slave type does not match the one specified in the conversion table.)

| | | | | | | | | | |
|-----|-----|-----|-----|-----|-----|-----|-----|-----|-----|
| | | #7 | #6 | #5 | #4 | #3 | #2 | #1 | #0 |
| DGN | 321 | XE3 | XE2 | XE1 | XE0 | ER3 | ER2 | ER1 | ER0 |

Indicates the cause of an FSSBC error.

- #0(ER0): INFORMED ERROR
- #1(ER1): (RESERVE)
- #2(ER2): Master port disconnection
- #3(ER3): External EMG input

Indicates the cause of an FSSBC error resulting from a request from a slave.

- #4(XE0): (RESERVE)
- #5(XE1): Slave port disconnection
- #6(XE2): Master port disconnection
- #7(XE3): External EMG input

| | | | | | | | | | |
|-----|-----|----|----|----|----|-----|-----|-----|-----|
| | | #7 | #6 | #5 | #4 | #3 | #2 | #1 | #0 |
| DGN | 330 | | | | | EXT | DUA | ST1 | ST0 |

| | | | | | | | | | |
|-----|-----|----|----|----|----|-----|-----|-----|-----|
| | | #7 | #6 | #5 | #4 | #3 | #2 | #1 | #0 |
| DGN | 332 | | | | | EXT | DUA | ST1 | ST0 |

| | | | | | | | | | |
|-----|-----|----|----|----|----|-----|-----|-----|-----|
| | | #7 | #6 | #5 | #4 | #3 | #2 | #1 | #0 |
| DGN | 348 | | | | | EXT | DUA | ST1 | ST0 |

#0, #1(ST0, ST1): Indicates the type code for an actually connected slave.

| ST1 | ST0 | Type | Address |
|-----|-----|--------------|--|
| 0 | 0 | A | Servo amplifier |
| 0 | 1 | (B: RESERVE) | (Currently nonexistent) |
| 1 | 0 | C | Stand-alone type detector interface unit |
| 1 | 1 | (RESERVE) | (Currently nonexistent) |

#2(DUA): 0 : The slave of interest is not on the first axis of the two-axis amplifier.
 1 : The slave of interest is on the first axis of the two-axis amplifier.

#3(EXT): 0 : The slave of interest does not exist.
 1 : The slave of interest exists.

| | | | | | | | | | |
|-----|-----|----|----|-----|-----|-----|-----|-----|-----|
| DGN | 331 | #7 | #6 | #5 | #4 | #3 | #2 | #1 | #0 |
| | | | | DMA | TP1 | TP0 | HA2 | HA1 | HA0 |
| DGN | 333 | #7 | #6 | #5 | #4 | #3 | #2 | #1 | #0 |
| | | | | DMA | TP1 | TP0 | HA2 | HA1 | HA0 |
| | to | | | | | | | | |
| DGN | 349 | #7 | #6 | #5 | #4 | #3 | #2 | #1 | #0 |
| | | | | DMA | TP1 | TP0 | HA2 | HA1 | HA0 |

#0, #1, #2(HA0, HA1, HA2): Indicates the host LSI address specified as a DMA destination.

#3, #4 (TP0, TP1): Indicates the type code of a specified slave.
 (See the above descriptions about ST0 and ST1.)

#5(DMA): Indicates a value determining whether to allow DMA to occur.

NOTE

A combination of parameter Nos. 330 and 331 corresponds to one FSSB slave unit. Up to ten slave units are available.

Slave units and the associated diagnosis numbers

| | | |
|---------------|---|----------------------------|
| Slave unit 00 | → | Diagnosis No. 330, No. 331 |
| Slave unit 01 | → | Diagnosis No. 332, No. 333 |
| Slave unit 02 | → | Diagnosis No. 334, No. 335 |
| Slave unit 03 | → | Diagnosis No. 336, No. 337 |
| Slave unit 04 | → | Diagnosis No. 338, No. 339 |
| Slave unit 05 | → | Diagnosis No. 340, No. 341 |
| Slave unit 06 | → | Diagnosis No. 342, No. 343 |
| Slave unit 07 | → | Diagnosis No. 344, No. 345 |
| Slave unit 08 | → | Diagnosis No. 346, No. 347 |
| Slave unit 09 | → | Diagnosis No. 348, No. 349 |

● **Details of invalid servo parameter setting alarms (on the servo side)**

| | | | |
|-----|-----|---|--|
| DGN | 350 | | } Not used in the FANUC Series 0i/0i Mate-MODEL C. |
| DGN | 351 | | |
| DGN | 352 | Detail number for invalid servo parameter setting alarm | |

Indicates information that can be used to identify the location (parameter) and cause of an invalid servo parameter setting alarm (servo alarm No. 417).

This diagnosis information is valid when the following conditions are satisfied.

- Servo alarm No. 417 has occurred.
- Bit 4 of diagnosis No. 203 (PRM) = 1

See the following table for the displayed detail numbers and the corresponding causes. For further detail information that could be used to take measures, refer to FANUC AC Servo Motor α iS/ α iF/ β iS series Parameter Manual (B-65270EN).

● **Detailed descriptions about invalid servo parameter setting alarms**

| Detail number | Parameter number | Cause | Measure |
|----------------------|------------------|---|---|
| 0233 | 2023 | A value specified as the number of velocity pulses is greater than 13100 when initialization bit 0 = 1. | Decrease the value specified as the number of velocity pulses to within 13100. |
| 0243 | 2024 | A value specified as the number of position pulses is greater than 13100 when initialization bit 0 = 1. | Decrease the value specified as the number of position pulses to within 13100. |
| 0434 0435 | 2043 | The internal value of the velocity loop integration gain has overflowed. | Decrease the value specified in the velocity loop integration gain parameter. |
| 0444 0445 | 2044 | The internal value of the velocity loop proportional gain has overflowed. | Use a function for changing the internal format of the velocity loop proportional gain. |
| 0474 0475 | 2047 | The internal value of the observer parameter (POA1) has overflowed. | Change the setting to: $(-1) \times (\text{desired setting})/10$ |
| 0534 0535 | 2053 | The internal value of the dead zone compensation parameter has overflowed. | Decrease the setting until the invalid parameter setting alarm will not occur any longer. |
| 0544 0545 | 2054 | The internal value of the dead zone compensation parameter has overflowed. | Decrease the setting until the invalid parameter setting alarm will not occur any longer. |
| 0686 0687 0688 | 2068 | The internal value of the feedforward coefficient has overflowed. | Use the position gain magnification function. |

| Detail number | Parameter number | Cause | Measure |
|------------------------------|------------------|--|---|
| 0694 0695 0696 0699 | 2069 | The interval value of the velocity feedforward coefficient has overflowed. | Decrease the velocity feedforward coefficient. |
| 0754 0755 | 2075 | The setting of the parameter listed at the left has overflowed. | This parameter is presently not in use. Specify 0 in it. |
| 0764 0765 | 2076 | The setting of the parameter listed at the left has overflowed. | This parameter is presently not in use. Specify 0 in it. |
| 0783 | 2078 | The conversion coefficient parameter listed at the left has not been set up for a full-closed loop linear motor (for the Series 9080 only). | Set a value in this parameter. |
| 0793 | 2079 | The conversion coefficient parameter listed at the left has not been set up for a full-closed loop linear motor (for the Series 9080 only). | Set a value in this parameter. |
| 0843 | 2084 | No positive value has been set for the flexible feed gear numerator. Alternatively, the following condition exists: Feed gear numerator > denominator | Specify a positive value as the flexible feed gear numerator. Alternatively, satisfy the following condition: Feed gear numerator \leq denominator (except for phase A-/B-specific stand-alone type detector). |
| 0853 | 2085 | No positive value has been set as the flexible feed gear denominator. | Specify a positive value as the flexible feed gear denominator. |
| 0884 0885 0886 | 2088 | The internal value of the machine velocity feedback coefficient has overflowed. | Decrease the machine velocity feedback coefficient. Alternatively, use the damping control function, which has an equivalent effect. |
| 0883 | 2088 | A value of 100 or greater was specified in the machine velocity feedback coefficient for an axis with a serial stand-alone type detector. | The maximum allowable value for the machine velocity feedback coefficient for axes with a serial stand-alone type detector is 100. Decrease the setting to within 100. |
| 0926 0927 0928 | 2092 | The interval value of the advance feedforward coefficient has overflowed. | Use the position gain magnification function. |
| 0996 | 2099 | The internal value for suppressing N pulses has overflowed. | Decrease the setting of the parameter listed at the left. |
| 1123 | 2112 | No value has been entered for the AMR conversion coefficient parameter when a linear motor is in use. | Specify the AMR conversion coefficient. |
| 1183 | 2118 | No value has been specified in the semi-/full-closed loop error threshold parameter for a full-closed loop linear motor (for the Series 9080 only). | Specify a semi-/full-closed loop error threshold value for the parameter listed at the left. |
| 1284 1285 | 2128 | If the value specified as the number of velocity pulses is small, the internal value of the current control parameter overflows. | Decrease the value for the parameter listed at the left to within a range where no alarm will occur any longer. |

| Detail number | Parameter number | Cause | Measure |
|------------------------------|------------------|--|--|
| 1294 1295 | 2129 | If the value specified as the number of velocity pulses is large, the internal value of the current control parameter overflows. | Re-set "a" to a smaller value when the setting of the parameter listed at the left is broken up into: $a \times 256 + b$ |
| 1393 | 2139 | The setting of the linear motor AMR offset has exceeded ± 45 . | Decrease the setting of the parameter listed at the left to within ± 45 . |
| 1446 1447 1448 | 2144 | The cutting feedforward coefficient for the cutting-/rapid traverse-specific FAD function has overflowed. | Use the position gain magnification function. |
| 1454 1455 1456 1459 | 2145 | The cutting velocity feedforward coefficient for the cutting-/rapid traverse-specific FAD function has overflowed. | Decrease the velocity feedforward coefficient. |
| 8213 | 1821 | No positive value has been set in the reference counter capacity parameter. | Specify a positive value in the parameter listed at the left. |
| 8254 8255 8256 | 1825 | The internal value of the position gain has overflowed. | Use the position gain magnification function. |
| 10016 10019 | 2200 bit 0 | The internal value of a parameter used to detect runaway has overflowed. | Do not use the runaway detection function (specify bit 0 = 1). |
| 10043 | 1815#1 2010#2 | A full-closed loop has been set up for a linear motor (except for the Series 9080). | A full-closed loop cannot be specified for linear motors. |
| 10053 | 2018#0 | The scale reverse connection bit has been set up for a linear motor. | The scale reverse connection bit cannot be used for linear motors. |
| 10062 | 2209#4 | The amplifier in use does not support the HC alarm avoidance function. | If you want to use this amplifier, reset the function bit listed at the left to 0. If you want to use the HC alarm avoidance function, use an amplifier that supports it. |

• Error detection

| | | | |
|-----|-----|-------------------------------------|--|
| DGN | 353 | | } Not used in the FANUC Series 0i/0i Mate-MODEL C. |
| | to | | |
| DGN | 358 | | |
| DGN | 360 | Cumulative command pulse count (NC) | |

[Data type] Two-word axis

[Unit of data] Detection unit

[Valid data range] -99999999 to 99999999

Indicates the cumulative count of movement commands distributed from the CNC since the power was switched on.

DGN 361 Cumulative compensation pulse count (NC)

[Data type] Word axis

[Unit of data] Detection unit

[Valid data range] -32767 to 32767

Indicates the cumulative count of compensation pulses (backlash compensation, pitch error compensation, etc.) distributed from the CNC since the power was switched on.

DGN 362 Cumulative command pulse count (SV)

[Data type] Two-word axis

[Unit of data] Detection unit

[Valid data range] -99999999 to 99999999

Indicates the cumulative count of movement command and compensation pulses received at the servo section since the power was switched on.

DGN 363 Cumulative feedback pulse count (SV)

[Data type] Two-word axis

[Unit of data] Detection unit

[Valid data range] -99999999 to 99999999

Indicates the cumulative count of position feedback pulses received from the pulse coder by the servo section.

| | | | | |
|-----|-----|--|---|---|
| DGN | 364 | | } | Not used in the FANUC Series 0i/0i Mate-MODEL C. |
| DGN | 370 | | | |
| | to | | | |
| DGN | 379 | | | |

● **Diagnostic data related to the Inductosyn absolute position detector**

DGN 380 Difference between the absolute position of the motor and offset data

[Data type] Two-word axis

[Units of data] Detection units

$$\frac{M(\text{absolute position of the motor}) - S(\text{offset data})}{\lambda(\text{pitch interval})}$$

The remainder resulting from the division is displayed.

| | | |
|-----|-----|---------------------------------|
| DGN | 381 | Offset data from the Inductosyn |
|-----|-----|---------------------------------|

[Data type] Two-word axis

[Units of data] Detection units

Off set data is displayed when CNC calculates the machine position.

● Serial spindle

| | | | | | | | | | |
|-----|-----|----|----|----|-----|-----|-----|-----|-----|
| | | #7 | #6 | #5 | #4 | #3 | #2 | #1 | #0 |
| DGN | 400 | | | | SAI | SS2 | SSR | POS | SIC |

#4(SAI) 0 : Spindle analog control is not used.

1 : Spindle analog control is used.

#3(SS2) 0 : Spindle serial doesn't control 2nd spindle.

1 : Spindle serial control 2nd spindle.

#2(SSR) 0 : Spindle serial control is not performed.

1 : Spindle serial control is performed.

#1 (POS) A module required for spindle analog control is

0 : not mounted

1 : mounted

#0 (SIC) A module required for spindle serial control is

0 : not mounted

1 : mounted

| | | |
|-----|-----|---|
| DGN | 401 | Serial spindle alarm state of First spindle |
|-----|-----|---|

| | | |
|-----|-----|--|
| DGN | 402 | Serial spindle alarm state of Second spindle |
|-----|-----|--|

| | | |
|-----|-----|---------------------------------|
| DGN | 403 | First spindle motor temperature |
|-----|-----|---------------------------------|

| | | |
|-----|-----|----------------------------------|
| DGN | 404 | Second spindle motor temperature |
|-----|-----|----------------------------------|

[Data type] Byte

[Unit of data] °C

[Valid data range] 0 to 255

The α_i spindle motor coil temperature is indicated.

This temperature is used as a guideline for occurrence of the spindle overheat alarm.

(However, the temperature at which overhear occurs varies with the motor.)

NOTE

- 1 The temperature data must fall within the following ranges.
 - 50°C to 160°C ± 5°C
 - 160°C to 180°C ± 10°C
- 2 The indicated temperature and the temperature at which overheat occurs have the following errors.
 - 160°C or less Up to 5°C
 - 160°C to 180°C Up to 10°C
- 3 For spindles older than the αi spindle, this function is invalid.
- 4 When the system configuration of the spindle (even another spindle) includes an additional spindle older than the αi spindle, this function is invalid.

| | | | | | | | | | |
|-----|-----|----|----|----|----|----|----|-----|-----|
| | | #7 | #6 | #5 | #4 | #3 | #2 | #1 | #0 |
| DGN | 407 | | | | | | | S2C | S1C |

[Data type] Bit

Indicates the cause of the generation of alarm 749 on the first/second spindle.

S1C: An error occurred in the communication data for the first spindle.

S2C: An error occurred in the communication data for the second spindle.

| | | | | | | | | | |
|-----|-----|-----|----|-----|-----|-----|-----|-----|-----|
| | | #7 | #6 | #5 | #4 | #3 | #2 | #1 | #0 |
| DGN | 408 | SSA | | SCA | CME | CER | SNE | FRE | CRE |

#0 (CRE): A CRC error occurred. (Warning)

#1 (FRE): A framing error occurred. (Warning)

#2 (SNE): The transmission/reception target is invalid.

#3 (CER): An error occurred during reception.

#4 (CME): No response was returned during automatic scanning.

#5 (SCA): A communication alarm occurred on the spindle amplifier side.

#7 (SSA): A system alarm occurred on the spindle amplifier side.

(These problems cause spindle alarm 749. Such problems are mainly caused by noise, disconnection, or instantaneous power-off).

| | | | | | | | | | |
|-----|-----|----|----|----|----|-----|-----|-----|-----|
| | | #7 | #6 | #5 | #4 | #3 | #2 | #1 | #0 |
| DGN | 409 | | | | | SPE | S2E | S1E | SHE |

Refer to this diagnosis when alarm 750 has generated.

#3 (SPE) In spindle serial control serial spindle parameters

0 : Satisfy start condition of spindle unit

1 : Do not satisfy start condition of spindle unit

#2 (S2E) 0 : 2nd spindle started normally in spindle serial control.

1 : 2nd spindle did not start normally in spindle serial control.

#1 (S1E) 0 : 1st spindle started normally in spindle serial control.

1 : 1st spindle did not start normally in spindle serial control.

#0 (SHE) 0 : Serial communication module is correct on CNC side.

1 : An error occurred in serial communication module on CNC side

| | | |
|-----|-----|--|
| DGN | 410 | Load meter of 1st spindle [%] |
| DGN | 411 | Speed meter of 1st spindle [min ⁻¹] |
| DGN | 412 | Load meter of 2nd spindle [%] |
| DGN | 413 | Speed meter of 2nd spindle [min ⁻¹] |
| DGN | 414 | Position error in 1st spindle synchronous control mode |
| DGN | 415 | Position error in 2nd spindle synchronous control mode |
| DGN | 416 | Absolute value of synchronization error between 1st and 2nd spindles |
| DGN | 417 | Feedback information of 1st spindle position coder |
| DGN | 418 | Position error of 1st spindle position loop mode |
| DGN | 419 | Feedback information of 2nd spindle position coder |
| DGN | 420 | Feedback information of 2nd spindle position coder |
| DGN | 421 | } Not used in the FANUC Series 0i/0i Mate-MODEL C. |
| | to | |
| DGN | 424 | |
| | | |
| DGN | 425 | First-spindle synchronization error |
| DGN | 426 | Second-spindle synchronization error |
| DGN | 427 | } Not used in the FANUC Series 0i/0i Mate-MODEL C. |
| DGN | 428 | |

No. 425 to 428: Indicates the absolute value of a synchronization error in synchronization mode where each spindle is treated as a slave axis.

NOTE

- 1 The temperature data must fall within the following ranges.
 - 50°C to 160°C ± 5°C
 - 160°C to 180°C ± 10°C
- 2 The indicated temperature and the temperature at which overheat occurs have the following errors.
 - 160°C or less Up to 5°C
 - 160°C to 180°C Up to 10°C
- 3 For spindles older than the αi spindle, this function is invalid.
- 4 When the system configuration of the spindle (even another spindle) includes an additional spindle older than the αi spindle, this function is invalid.

| | | |
|-----|-----|------------------------------|
| DGN | 445 | First-spindle position data |
| DGN | 446 | Second-spindle position data |

[Data type] Word

[Unit of data] Pulse

[Valid data range] 0 to 4095

This parameter is valid when bit 1 of parameter No. 3117 = 1.

To display the position data of a spindle, execute spindle orientation.

| | | |
|-----|-----|---|
| DGN | 447 | } Not used in the FANUC Series 0i/0i Mate-MODEL C. |
| DGN | 448 | |

● **Diagnostic data related to rigid tapping**

| | | |
|-----|-----|---|
| DGN | 450 | Spindle position error during rigid tapping |
|-----|-----|---|

[Data type] Word

[Unit of data] Detection units

| | | |
|-----|-----|---|
| DGN | 451 | Spindle distribution during rigid tapping |
|-----|-----|---|

[Data type] Word

[Unit of data] Detection units

DGN 452 Momentary error difference between the spindle and tapping axis during rigid tapping (signed)

[Unit of data] %

NOTE

This data item is displayed only when bit 0 (DGN) of parameter No. 5204 is set to 1.

DGN 453 Maximum error difference between the spindle and tapping axis during rigid tapping (absolute value)

[Unit of data] %

NOTE

This data item is displayed only when bit 0 (DGN) of parameter No. 5204 is set to 1.

DGN 454 Accumulated spindle distribution during rigid tapping

[Data type] Two-word

[Unit of data] Detection units

DGN 455 Instantaneous difference for the move command, calculated in terms of the spindle, during rigid tapping (signed, accumulated value)

[Data type] Two-word

[Unit of data] Detection units

DGN 456 Instantaneous difference for the travel error, calculated in terms of the spindle, during rigid tapping (signed)

[Data type] Word

[Unit of data] Detection units

DGN 457 Width of synchronization error during rigid tapping (maximum value)

[Data type] Word

[Unit of data] Detection units

● Open CNC

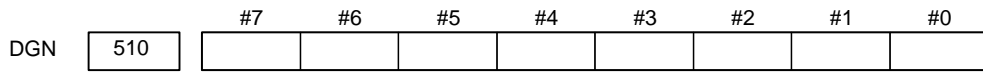

This data indicates the internal Open CNC information (not available to general users).

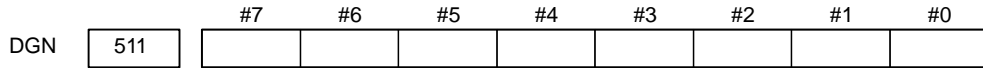

This data indicates the internal Open CNC information (not available to general users).

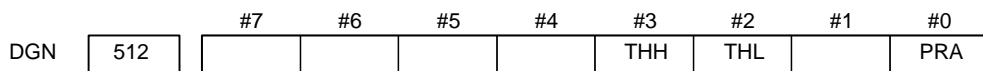

This data indicates the cause of a system alarm that has occurred in Open CNC.

- #0(PRA) 0 : Normal
- 1 : A RAM parity error occurred in shared RAM.

#3, #2(THL, THH):

| THL | THH | Status |
|-----|-----|--|
| 0 | 0 | A battery alarm has occurred in the PANEL <i>i</i> or CNC display unit with PC functions. |
| 1 | 0 | A high-temperature condition has occurred in the PANEL <i>i</i> or CNC display unit with PC functions. |
| 0 | 1 | A low-temperature condition has occurred in the PANEL <i>i</i> or CNC display unit with PC functions. |
| 1 | 1 | Normal (connected to the PC) |

- #4 0 : Normal
- 1 : An NMI has occurred in HSSB.

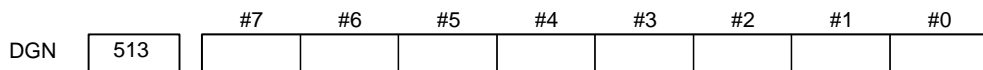

Indicates the internal information about the HSSB (open CNC). (Hidden function)

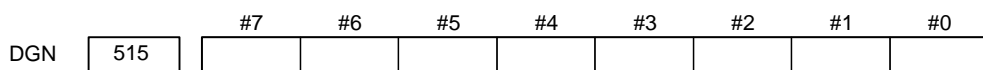

Indicates the internal information about the HSSB (channel 2). (Hidden function)

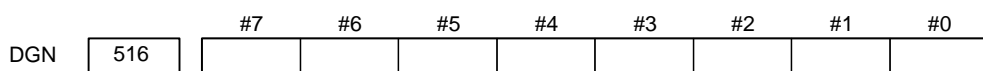

Indicates the internal information about the HSSB (channel 2). (Hidden function)

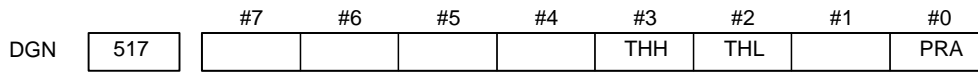

Indicates the internal information about the HSSB (channel 2) as follows.

#0(PRA): 0 : Normal

1 : A RAM parity error has occurred in shared RAM.

#3, #2(THL, THH):

| THL | THH | Status |
|-----|-----|--|
| 0 | 0 | A battery alarm has occurred in the PANEL <i>i</i> or CNC display unit with PC functions. |
| 1 | 0 | A high-temperature condition has occurred in the PANEL <i>i</i> or CNC display unit with PC functions. |
| 0 | 1 | A low-temperature condition has occurred in the PANEL <i>i</i> or CNC display unit with PC functions. |
| 1 | 1 | Normal (connected to the PC) |

#4: 0 : Normal

1 : An NMI has occurred in the HSSB.

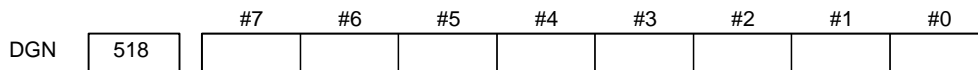

Indicates the internal information about the HSSB (channel 2). (Hidden function)

● **Diagnostic data related to a small-diameter peck drilling cycle (M series only)**

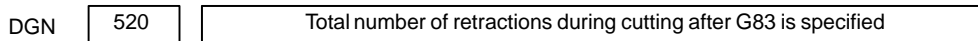

Executing the G83 command clears the value to zero.

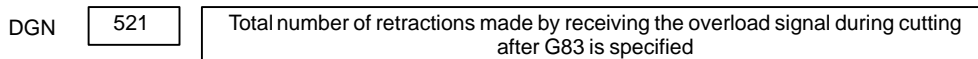

Executing the G83 command clears the value to zero.

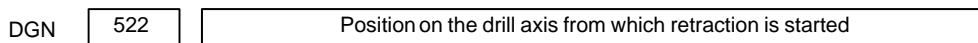

The units are the same as the minimum input increment.

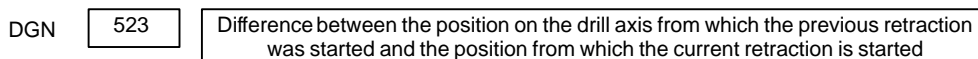

The units are the same as the minimum input increment.

● **Diagnostic data related to simple synchronous control**

| | | |
|-----|-----|--|
| DGN | 540 | Difference in the position error between the master and slave axes in simple synchronous control |
| DGN | 541 | Difference in the position error between the master and slave axes in simple synchronous control |

DGN 540 indicates the difference in the position error between the master and slave axes when a single axis pair is subjected to simple synchronous control. DGN 541 is used when two or more pairs are subjected to simple synchronous control. The position error is indicated for the master axis.

DGN 540 and 541 indicate values in detection units. They are displayed only with the M series.

● **Status after execution of manual tool compensation (for the T series only)**

| | | |
|-----|-----|--|
| DGN | 560 | Status after execution of manual tool compensation |
|-----|-----|--|

- 0 : Manual tool compensation ended normally.
- 1 : The data of the T code command is out of the allowable range.
- 2 : The offset value is out of the allowable range.
- 3 : The offset number is out of the allowable range.
- 4 : The CNC is running automatically or moving the axes.
- 5 : The CNC is in tool tip radius compensation mode.
- 6 : The CNC is not in JOG or HNDL (INCR) mode.
- 7 : The setting of a CNC parameter is invalid.

● **FSSB2 status**

| | | | | | | | | | |
|-----|-----|-----|----|-----|-----|-----|-----|-----|-----|
| | | #7 | #6 | #5 | #4 | #3 | #2 | #1 | #0 |
| DGN | 620 | CFE | | ERR | ERP | OPN | RDY | OPP | CLS |

Indicates the internal status of the FSSBC2.

- #0(CLS):** Closed.
- #1(OPP):** Running OPEN protocol.
- #2(RDY):** Open and ready.
- #3(OPN):** Open.
- #4(ERP):** Running ERROR protocol.
- #7(CFE):** Encountered configuration error.
(The actual slave type does not match the one specified in the conversion table.)

| | | | | | | | | | |
|-----|-----|-----|-----|-----|-----|-----|-----|-----|-----|
| | | #7 | #6 | #5 | #4 | #3 | #2 | #1 | #0 |
| DGN | 621 | XE3 | XE2 | XE1 | XE0 | ER3 | ER2 | ER1 | ER0 |

Indicates the cause of an FSSBC2 error.

- #0(ER0): INFORMED ERROR
- #1(ER1): (RESERVE)
- #2(ER2): Master port disconnection
- #3(ER3): External EMG input

Indicates the cause of an FSSBC2 error resulting from a request from a slave.

- #4(XE0): (RESERVE)
- #5(XE1): Slave port disconnection
- #6(XE2): Master port disconnection
- #7(XE3): External EMG input

| | | | | | | | | | |
|-----|-----|----|----|----|----|-----|-----|-----|-----|
| | | #7 | #6 | #5 | #4 | #3 | #2 | #1 | #0 |
| DGN | 630 | | | | | EXT | DUA | ST1 | ST0 |

| | | | | | | | | | |
|-----|-----|----|----|----|----|-----|-----|-----|-----|
| | | #7 | #6 | #5 | #4 | #3 | #2 | #1 | #0 |
| DGN | 632 | | | | | EXT | DUA | ST1 | ST0 |

to

| | | | | | | | | | |
|-----|-----|----|----|----|----|-----|-----|-----|-----|
| | | #7 | #6 | #5 | #4 | #3 | #2 | #1 | #0 |
| DGN | 648 | | | | | EXT | DUA | ST1 | ST0 |

#0, #1(ST0, ST1): Indicates the type code for an actually connected slave.

| ST1 | ST0 | Type | Address |
|-----|-----|--------------|--|
| 0 | 0 | A | Servo amplifier |
| 0 | 1 | (B: RESERVE) | (Currently nonexistent) |
| 1 | 0 | C | Stand-alone type detector interface unit |
| 1 | 1 | (RESERVE) | (Currently nonexistent) |

- #2(DUA): 0 : The slave of interest is not on the first axis of the two-axis amplifier.
1 : The slave of interest is on the first axis of the two-axis amplifier.
- #3(EXT): 0 : The slave of interest does not exist.
1 : The slave of interest exists.

| | | | | | | | | | |
|-----|-----|----|----|-----|-----|-----|-----|-----|-----|
| | | #7 | #6 | #5 | #4 | #3 | #2 | #1 | #0 |
| DGN | 631 | | | DMA | TP1 | TP0 | HA2 | HA1 | HA0 |
| | | #7 | #6 | #5 | #4 | #3 | #2 | #1 | #0 |
| DGN | 633 | | | DMA | TP1 | TP0 | HA2 | HA1 | HA0 |
| | to | #7 | #6 | #5 | #4 | #3 | #2 | #1 | #0 |
| DGN | 649 | | | DMA | TP1 | TP0 | HA2 | HA1 | HA0 |

#0, #1, #2(HA0, HA1, HA2): Indicates the host LSI address specified as a DMA destination.

#3, #4 (TP0, TP1): Indicates the type code of a specified slave.
(See the above descriptions about ST0 and ST1.)

#5(DMA): Indicates a value determining whether to allow DMA to occur.

NOTE

A combination of parameter Nos. 630 and 631 corresponds to one FSSB2 slave unit. Up to ten slave units are available.

Slave units and the associated diagnosis numbers

| | | |
|---------------|---|----------------------------|
| Slave unit 00 | → | Diagnosis No. 630, No. 631 |
| Slave unit 01 | → | Diagnosis No. 632, No. 633 |
| Slave unit 02 | → | Diagnosis No. 634, No. 635 |
| Slave unit 03 | → | Diagnosis No. 636, No. 637 |
| Slave unit 04 | → | Diagnosis No. 638, No. 639 |
| Slave unit 05 | → | Diagnosis No. 640, No. 641 |
| Slave unit 06 | → | Diagnosis No. 642, No. 643 |
| Slave unit 07 | → | Diagnosis No. 644, No. 645 |
| Slave unit 08 | → | Diagnosis No. 646, No. 647 |
| Slave unit 09 | → | Diagnosis No. 648, No. 649 |

| Number | Message | Contents |
|--------|--------------------|--|
| 680 | POWER ON CHECK SUM | Displays the parameter checksum at power on. The checksum is displayed only if CKS, bit 0 of parameter No. 13730, is 1. |
| 681 | STANDARD CHECK SUM | Displays the checksum value when CKS, bit 0 of parameter No. 13730, is set from 0 to 1. The value is always displayed once you create a reference checksum. |
| 682 | CALCULATION DATE | Displays the date when CKS, bit 0 of parameter No. 13730, is set to 0 to 1. The value is always displayed once you create a reference checksum. |
| 683 | CALCULATION TIME | Displays the time when CKS, bit 0 of parameter No. 13730, is set to 0 to 1. The value is always displayed once you create a reference checksum. |

The checksum is calculated not by adding all parameters together but by excluding specific parameters. The parameters to be excluded are those listed below.

- <1> Parameters that enable input of settings
- <2> Parameters that FANUC decided to be excluded in advance
- <3> Parameters specified in parameters Nos. 13731 to 13750
- <4> Parameters whose ranges are specified in parameters No. 13751 to 13770

For information on parameters described in <2>, see the table below.

Nos. of the parameters not included in the checksum (M series)

| Parameter number | Contents |
|------------------|---|
| 1220 to 1226 | Workpiece zero point offset value |
| 1244 | Coordinate of the floating reference position |
| 1320 to 1321 | Coordinates of the boundary of stored stroke check 1 |
| 1322 to 1323 | Coordinates of the boundary of stored stroke check 2 |
| 1860 to 1861 | Counter of the absolute-position detector |
| 3120 | Period of time from the time a wave diagnosis error occurs until sampling stops |
| 3271 | LCD number when the power supply unit connected to two LCD units is turned off |
| 4911 to 4914 | Spindle speed fluctuation detection |
| 6350 | Fine torque sensing |
| 6360 to 6363 | Fine torque sensing |
| 6561 to 6575 | VGA graphic color number |
| 6581 to 6595 | VGA character color number |
| 6750 | Accumulated power-on time |
| 7220 to 7283 | Names of the general-purpose switches on the operating panel |
| 8182 | Axis recomposition Display of the sync error amount |
| 8370 | Chopping axis number |
| 8371 to 8374 | Chopping reference point/upper dead point/lower dead point/velocity |
| 8860 to 8861 | Fault prediction level of the fault diagnosis function |
| 8900 | PWE |
| 12801 to 12820 | Signal symbol table number for selecting an operation history signal |
| 12841 to 12860 | Signal number for selecting an operation history signal |
| 12881 to 12900 | Mask pattern for selecting an operation history signal |
| 12901 to 12925 | Signal symbol table number for selecting an operation history signal |

Nos. of the parameters not included in the checksum (M series)

| Parameter number | Contents |
|------------------|---|
| 12930 to 12955 | Signal number for selecting an operation history signal |
| 12961 to 12985 | Mask pattern for selecting an operation history signal |

Nos. of the parameters not included in the checksum (T series)

| Parameter number | Contents |
|------------------|--|
| 1220 to 1226 | Workpiece zero point offset value |
| 1244 | Coordinate of the floating reference position |
| 1320 to 1321 | Coordinates of the boundary of stored stroke check 1 |
| 1322 to 1323 | Coordinates of the boundary of stored stroke check 2 |
| 1330 to 1348 | Chuck/tailstock barrier |
| 1860 to 1861 | Counter of the absolute-position detector |
| 3120 | Period of time from the time a wave diagnosis error occurs until sampling stops |
| 3271 | LCD number when the power supply unit connected to two LCD units is turned off |
| 4911 to 4914 | Spindle speed fluctuation detection |
| 5130 | Amount of chamfering in the threading cycle (G96 or G92) |
| 5132 to 5133 | Dept of cut/clearance in the multiple repetitive canned cycle G71 or G72 |
| 5135 | Clearance on the X-axis in the multiple repetitive canned cycle G73 |
| 5136 | Clearance on the Z-axis in the multiple repetitive canned cycle G73 |
| 5137 | Number of divisions in the multiple repetitive canned cycle G73 |
| 5139 | Amount of return in the multiple repetitive canned cycle G74 or G75 |
| 5140 | Minimum depth of cut in the multiple repetitive canned cycle G76 |
| 5141 | Finishing allowance in the multiple repetitive canned cycle G76 |
| 5142 | Number of repetitions of the last finish in the multiple repetitive canned cycle G76 |
| 5143 | Tool nose angle in the multiple repetitive canned cycle G76 |
| 6350 | Fine torque sensing |
| 6360 to 6363 | Fine torque sensing |
| 6500 | Graphic display |
| 6561 to 6575 | VGA graphic color number |
| 6581 to 6595 | VGA character color number |
| 6750 | Accumulated power-on time |

Nos. of the parameters not included in the checksum (T series)

| Parameter number | Contents |
|------------------|--|
| 7220 to 7283 | Names of the general-purpose switches on the operating panel |
| 7625 | Polygon turning speed |
| 8182 | Axis recomposition Display of the sync error amount |
| 8860 to 8861 | Fault prediction level of the fault diagnosis function |
| 8900 | PWE |
| 12801 to 12820 | Signal symbol table number for selecting an operation history signal |
| 12841 to 12860 | Signal number for selecting an operation history signal |
| 12881 to 12900 | Mask pattern for selecting an operation history signal |

If you use the cutting condition selection function, the parameters listed in the table below are also excluded.

Nos. of the parameters not included in the checksum (when the cutting condition selection function is used)

| Parameter number | Contents |
|------------------|---|
| 1432 | Maximum cutting feedrate for each axis in advanced preview control/AI contour control/high-precision contour control mode |
| 1730 | Upper limit on the feedrate with the arc radius R |
| 1731 | Arc radius corresponding to the upper limit on the feedrate |
| 1769 | Time constant for cutting feedrate linear/bell-shaped acceleration/deceleration for each axis |
| 1770 | Parameter 1 for setting the acceleration for linear acceleration/deceleration before interpolation |
| 1771 | Parameter 2 for setting the acceleration for linear acceleration/deceleration before interpolation |
| 1772 | Time constant for bell-shaped acceleration/deceleration with a constant time of look-ahead acceleration before interpolation |
| 1783 | Per-axis permissible velocity difference for automatic corner deceleration with a velocity difference (for linear acceleration/deceleration before interpolation) |
| 1785 | Parameter for deciding on the permissible acceleration in velocity determination with acceleration |
| 1788 | Permissible acceleration change for each axis in velocity control with acceleration changes in jerk control |
| 1789 | Permissible acceleration change for each axis in velocity control with acceleration changes in jerk control during continuous linear interpolation |
| 1790 | Ratio of the jerk change time in smooth bell-shaped acceleration/deceleration before interpolation |
| 8400 | Parameter 1 for setting the acceleration for linear acceleration/deceleration before interpolation |

Nos. of the parameters not included in the checksum (when the cutting condition selection function is used)

| Parameter number | Contents |
|------------------|--|
| 8401 | Parameter 2 for setting the acceleration for linear acceleration/deceleration before interpolation |
| 8410 | Permissible velocity difference in velocity determination with a corner velocity difference |
| 8416 | Look-ahead bell-shaped acceleration/deceleration before interpolation |
| 8470 | Parameter for deciding on the permissible acceleration in velocity determination with acceleration |
| 13634 | Currently selected level in advanced preview control/AI contour control |
| 13680 | Currently selected level when high-precision contour control is used |
| 19522 | Permissible acceleration change for each axis in velocity control with acceleration changes in jerk control |
| 19523 | Permissible acceleration change for each axis in velocity control with acceleration changes in jerk control during continuous linear interpolation |
| 19524 | Ratio of the jerk change time in smooth bell-shaped acceleration/deceleration before interpolation |

Nos. of the parameters not included in the checksum (when the cutting condition selection function is used)

| Parameter number |
|--|
| Number of the parameter set in parameter No. 13628 (parameter number corresponding to arbitrary item 1 when advanced preview control/AI contour control is used) |
| Number of the parameter set in parameter No. 13629 (parameter number corresponding to arbitrary item 2 when advanced preview control/AI contour control is used) |
| Number of the parameter set in parameter No. 13674 (parameter number corresponding to arbitrary item 1 when high precision contour control is used) |
| Number of the parameter set in parameter No. 13675 (parameter number corresponding to arbitrary item 2 when high precision contour control is used) |

NOTE

- 1 If you do not use the cutting condition selection function, these parameters are included in the checksum.
- 2 Parameters whose numbers are set in parameters Nos. 13628, 13629, 13674, and 13675 are excluded, but parameters 13628, 13629, 13674, and 13675 themselves are not excluded.

● **State of high-speed HRV current control**

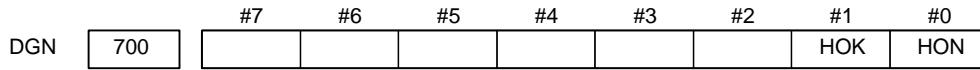

[Data type] Bit axis

The state of high-speed HRV current control is displayed.

HON: The motor is controlled in the high-speed HRV current control mode.

HOK: This bit is set to 1 when high-speed HRV current control is enabled.

High-speed HRV current control is enabled when the following conditions are satisfied:

- Bit 0 (HR3) of parameter No. 2013 is set to 1.
- Servo software, servo modules, and servo amplifiers suitable for high-speed HRV current control are used.
- When a separate detector interface unit is used, the separate detector interface unit is suitable for high-speed HRV current control.

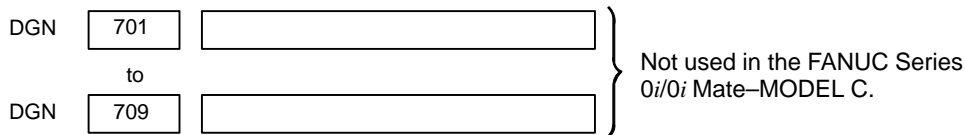

● **Error and warning statuses of the α i spindle**

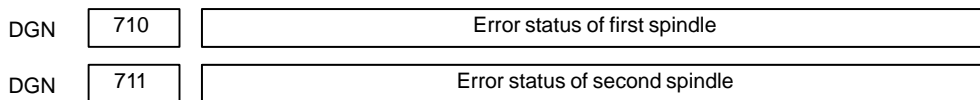

[Data type] Word

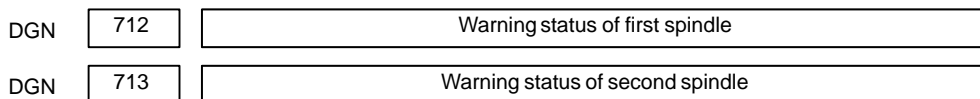

[Data type] Word

If an error (the yellow LED flashes and the error number appears) or warning occurred in the α i spindle amplifier module (SPM), the number is displayed on the diagnostic screen.

When there is no error or warning, "0" is indicated.

NOTE

- 1 For spindles older than the α i spindle, this function is invalid.
- 2 When the system configuration of the spindle (even another spindle) includes an additional spindle older than the α i spindle, this function is invalid.

Refer to the FANUC SERVO MOTOR α i series Maintenance Manual (B-65285EN) for errors on the α i spindle.

See Subsection 7.1.4, "Warning Interface for the α i Spindle" in this manual for warnings.

1.9 CNC STATE DISPLAY

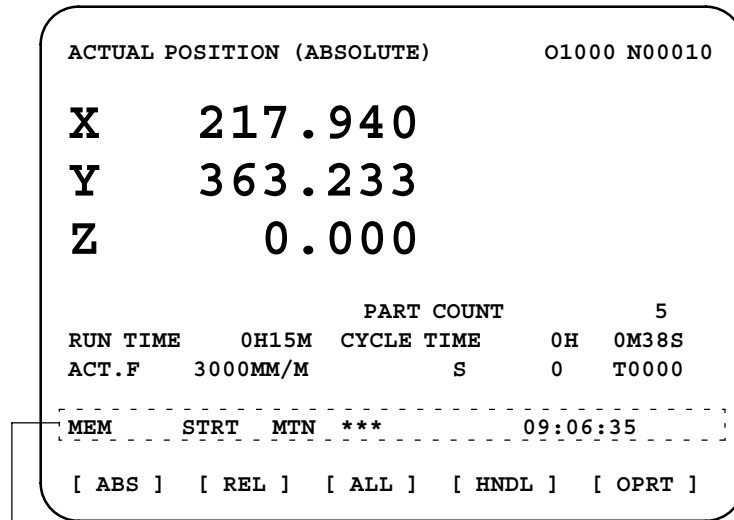

- Indicates the current status of the CNC.
- Display example and explanation

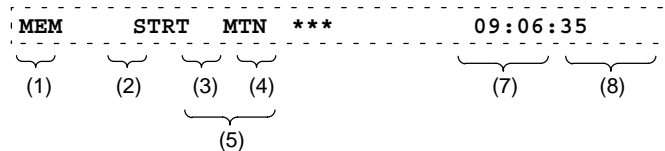

(1) Mode selection status

MEM: Automatic operation (memory operation)

MDI: Manual data input/MDI operation

EDIT: Program editing

RMT: Remote operation

JOG: Jog feed

REF: Reference position return

INC: Incremental feed mode = step feed (if no manual pulse generator is available)

HND: Manual handle feed mode

TJOG: Teaching in jog feed mode

THND: Teaching in handle feed mode

(2) Automatic operation status

STRT: Automatic operation has started (and program execution is under way).

HOLD: Automatic operation has been suspended (execution of a block has been discontinued, and automatic operation has stopped).

STOP: Automatic operation has stopped (a block has been finished, and automatic operation has stopped).

MSTR: The tool is returning or being repositioned when the tool retract and return function is executed.

****: Other status (when the power is switched on, or automatic operation has ended)

- (3) Automatic operation status
 MTN: Program-specified axis movement is under way.
 DWL: Program-specified dwell command (G04) is being executed.
 ***: Other status
- (4) Auxiliary function status
 FIN: The completion signal FIN for an auxiliary function is being awaited.
 ***: Other status
- (5) Emergency stop and reset status (displayed at the location of items mentioned in (3) and (4))
 —EMG— : Emergency stop status
 —RESET—: CNC reset status (The state in which the reset signal or the MDI RESET key remains active.)
- (6) Alarm status
 ALM : An alarm condition has been detected.
 BAT : The lithium battery (CNC back-up battery) voltage is low (the battery is to be replaced).
 Blank: Other status
- (7) Clock display: Hour:minute:second
- (8) Program editing/running status
 Input: Data is being input.
 Output: Data is being output.
 SRCH: A data search is under way.
 EDIT: Editing such as insertion or modification is under way.
 LSK: Label skip enabled at data input (until valid information is read).
 AI APC: AI advanced preview control mode
 AI CC: AI contour control mode
 Blank: Editing is not under way.

1.10 WAVEFORM DIAGNOSTIC FUNCTION

Tuning becomes easier by graphically displaying servo error amount and torque command, etc. (Graphic option is required).

The following two types of waveform diagnosis functions are supported:

(1) One-shot type

The one-shot type waveform diagnosis function can graphically display, as a waveform, any variation in those data items listed below. The start of data sampling can be triggered by the rising or falling edge of a machine signal. This function facilitates the adjustment of the servo and spindle motors.

- a. Error, pulse distribution amount, torque, speed, current, and thermal simulation data for the servo motor of each axis
- b. Composite speed for the first, second, and third axes
- c. Spindle motor speed and load meter value
- d. On/off state of a machine signal specified with a signal address

(2) Storage type

The storage type waveform diagnosis function enables the storing of any variation in the data items listed below and, if a servo alarm occurs, the graphical display (as a waveform) of the stored data. The end of data sampling can be triggered by the rising or falling edge of a machine signal. This function facilitates the estimation of erroneous locations. Stored data can be output via the reader/punch interface.

- a. Error, pulse distribution amount, torque, speed, current, and thermal simulation data for the servo motor for each axis

NOTE

- 1 To output stored waveform data, the optional reader/punch interface must have been installed.
- 2 The waveform diagnosis function is enabled when bit 0 (SGD) of parameter No. 3112 is set to 1. Note, however, that a graphics card is necessary to display waveforms.

1.10.1 Setting Parameters

| | | | | | | | | | |
|-----|------|----|----|----|----|----|----|----|-----|
| | | #7 | #6 | #5 | #4 | #3 | #2 | #1 | #0 |
| DGN | 3112 | | | | | | | | SGD |

- #0(SGD) 0 : Do not display servo waveform (usual graphic display).
- 1 : Displays servo waveform (usual graphic display function cannot be used).

| | | |
|-----|------|---|
| DGN | 3120 | Time between servo alarm and sampling stop (storage type) |
|-----|------|---|

[Data type] Word

[Unit of data] ms

[Valid data range] 1 to 32760



DGN 3121 Selection of data of waveform diagnosis storage type



[Data type] Byte

The sixth-type sampling data of storage type of the waveform diagnosis function is:

- 0 : Thermal simulation data
- 1 : Spindle load meter data of the first spindle

1.10.2 Waveform Diagnostic Parameter Screen

1. Press the  key to display a system screen such as a parameter.
2. Press the continuous menu key  several times, and the soft key [W.DGNS] is displayed.
3. Press [W.DGNS], then the parameter screen for the waveform diagnosis is displayed.

Set the necessary data items. Position the cursor to the item to be set, enter the corresponding data, then press . Data items for which ***** is displayed cannot be set. To assist in data setting, the frame on the right side of the screen displays help information for that data to which the cursor is positioned. Help information which cannot fit into a single frame is split into several pages, which the user can scroll through using the page keys  and .

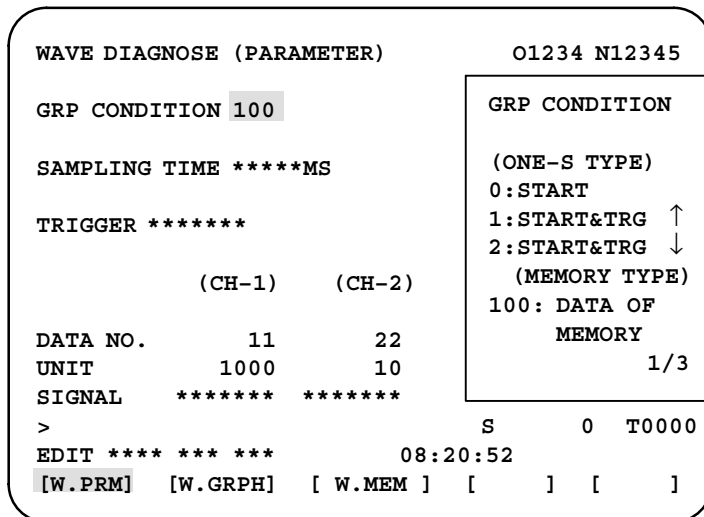

● **Waveform diagnosis parameters (one-shot type)**

- (1) Display start condition
 - 0 : Starts data sampling upon the [START] key being pressed, samples data for the specified period, then draws a waveform.
 - 1 : Starts data sampling upon the detection of the first rising edge of the trigger signal after the [START] key is pressed, samples data for the specified period, then draws a waveform.
 - 2 : Starts data sampling upon the detection of the first falling edge of the trigger signal after the [START] key is pressed, samples data for the specified period, then draws a waveform.

(2) Sampling period: Set the period during which data will be sampled.

Valid data range: 10 to 32760

Units: ms

(3) Trigger: Set the PMC address and bit for the signal used to trigger the start of data sampling, when 1 or 2 is set for the start condition.

Example) G0007.2: ST signal

(4) Data number: The table below lists the numbers of the data items for which a waveform can be displayed (n = 1 to 4).

| Data No. | Description | Units |
|----------|--|--|
| 00 | Does not display a waveform. | — |
| 0n | Servo error (8 ms) for the n–th axis (positional deviation) | Pulses (detection units) |
| 1n | Pulse distribution for the n–th axis (move command) | Pulses (input increments) |
| 2n | Torque for the n–th axis (actual current) | % (relative to maximum current) |
| 3n | Servo error (2 ms) for the n–th axis (positional deviation) | Pulses (detection units) |
| 5n | Actual speed for the n–th axis | min ⁻¹ |
| 6n | Command current for the n–th axis | % (relative to maximum current) |
| 7n | Thermal simulation data for the n–th axis | % (OVC alarm ratio) |
| 90 | Composite speed for the first, second, and third axes | Pulses (input increments) |
| 99 | On/off state of a machine signal specified with a signal address | None |
| 10n | Actual spindle speed for the n–th axis | % (relative to maximum rotation speed) |
| 11n | Load meter for the n–th spindle | % (relative to maximum output) |
| 161 | Difference in position error calculated on the spindle basis | Pulses (detection unit) |

(5) Data units: Weight of data when 1 is specified. The data units are automatically specified for each data item and need not be set unless the units must be changed for some reason.

[Valid data range] 1 to 1000

[Unit] 0.001

(6) Signal address: PMC address and bit number. Set in the same way as that for trigger, when the data number is 99.

● **Waveform diagnosis parameters (storage type)**

(1) Display start condition

100 : Draws a waveform for the stored data.

(2) Sampling period: Invalid

(3) Trigger: Invalid

(4) Data number: The table below lists the numbers of the data items for which a waveform can be displayed (n = 1 to 4). Numbers for which no data is stored cannot be specified.

| Data No. | Description | Units |
|----------|---|---------------------------------|
| 00 | Does not display a waveform. | — |
| 0n | Servo error (8 ms) for the n–th axis (positional deviation) | Pulses (detection units) |
| 1n | Pulse distribution for the n–th axis (move command) | Pulses (input increments) |
| 2n | Torque for the n–th axis (actual current) | % (relative to maximum current) |
| 5n | Actual speed for the n–th axis | min ⁻¹ |
| 6n | Command current for the n–th axis | % (relative to maximum current) |
| 7n | Thermal simulation data for the n–th axis (when the parameter No.3121 is set to 0.) | % (OVC alarm ratio) |
| 111 | Load meter for the n–th spindle (when the parameter No.3121 is set to 1.) | % (relative to maximum output) |

(5) Data units: Weight of data when 1 is specified. The data units are automatically specified for each data item and need not be set unless the units must be changed for some reason.

[Valid data range] 1 to 1000

[Unit] 0.001

(6) Signal address: Invalid

1.10.3 Graphic of Wave Diagnosis Data

1. Press soft key [**W.GRPH**], then graph of waveform diagnosis is displayed.

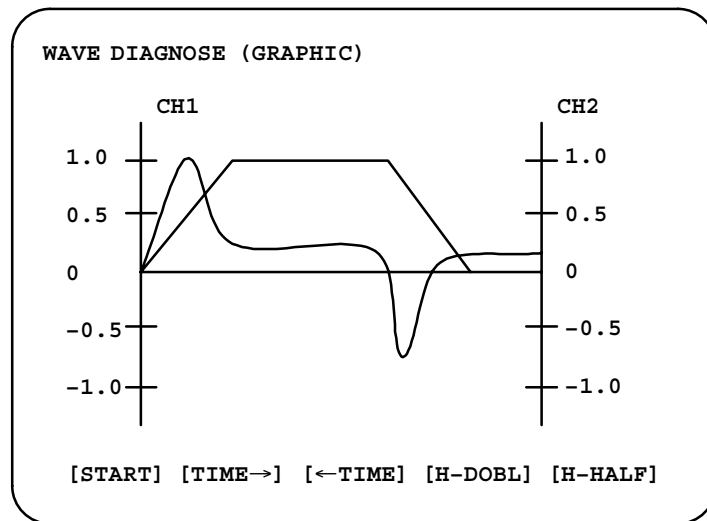

2. Press soft key [(**OPRT**)], then the following soft keys are displayed. The following three sets of soft keys are displayed by the  key.

[START] [TIME→] [←TIME] [H-DOBL] [H-DOBL]

[START] [CH-1↑] [CH-1↓] [V-DOBL] [V-HALF]

[START] [CH-2↑] [CH-2↓] [V-DOBL] [V-HALF]

- 1) [**START**] : Starts Graphic data
- 2) [**TIME→**] : Shift the waveform of channel 1 and 2 rightward
- 3) [**←TIME**] : Shift the waveform of channel and 2 leftward
- 4) [**H-DOBL**] : Double the time scale of the waveform of channel 1 and 2
- 5) [**H-HALF**] : Half the time scale of the waveform of channel 1 and 2
- 6) [**H-DOBL**] : Double the height of waveform of channel 1 and 2
- 7) [**V-HALF**] : Half the height of waveform of channel 1 and 2
- 8) [**CH-1↑**] : Shift the zero point of channel 1 upward
- 9) [**CH-1↓**] : Shift the zero point of channel 1 downward
- 10) [**CH-2↑**] : Shift the zero point of channel 2 upward
- 11) [**CH-2↓**] : Shift the zero point of channel 2 downward

- **Drawing a waveform for one-shot type waveform diagnosis**

The one-shot type waveform diagnosis function draws a waveform for a specified data item in real time as the data is sampled. The sampled data, however, is not stored and thus cannot be output later.

To sample data for one-shot type waveform diagnosis, press the [**START**] key on the WAVE DIAGNOS. (GRAPHIC) screen. Then, data is sampled when the specified start condition is satisfied. Data sampling continues for the specified period.

Pressing the [**SATART**] soft key starts data sampling. While sampling is being performed, **SAMPLING** blinks at the top of the screen. Once data sampling has been completed, a waveform is automatically displayed.

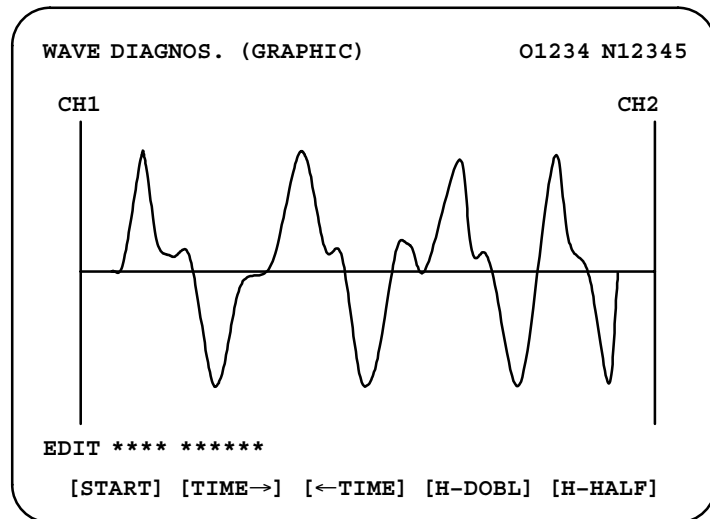

- **Drawing a waveform for storage type waveform diagnosis**

To use storage type waveform diagnosis, set 100 for the display start condition. The maximum data width for storage type waveform diagnosis is 32760 ms. Data must be sampled before starting drawing. The next page explains sampling in detail.

Pressing the [**START**] soft key loads stored data. While the data is being loaded, **SAMPLING** blinks at the top of the screen. Once the data has been loaded, a waveform is displayed. The date on which the data was stored is displayed at the top left of the screen. If the [**START**] soft key is pressed while data is being stored, storage is stopped and the waveform for the data stored up to that point is displayed. The **WAVE DIAGNOS. (MEMORY)** screen indicates whether data is being stored.

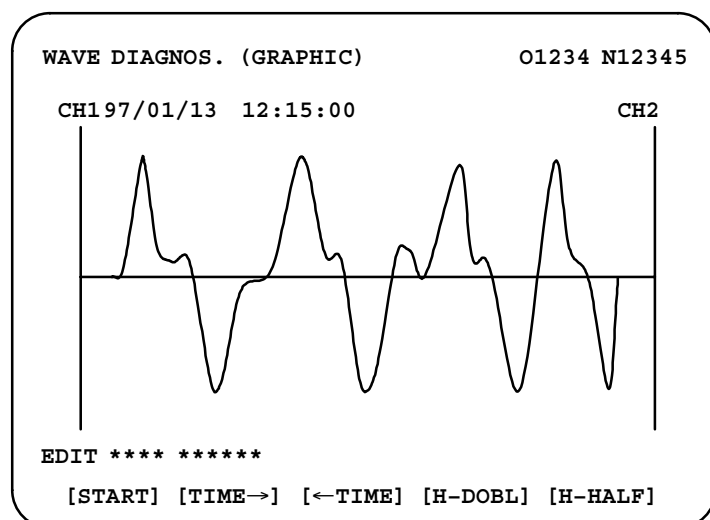

1.10.4 Data Sampling for Storage Type Waveform Diagnosis

- (1) Press the function key. Pressing the menu continuation key [▷] displays the [W.DGNS] soft key. Press this soft key to display the WAVE DIAGNOS. (PARAMETER) screen.
- (2) Press the [W.MEM] soft key to display the WAVE DIAGNOS. (MEMORY) screen. The operation selection soft keys appear. The configuration of the operation selection soft keys is as follows:

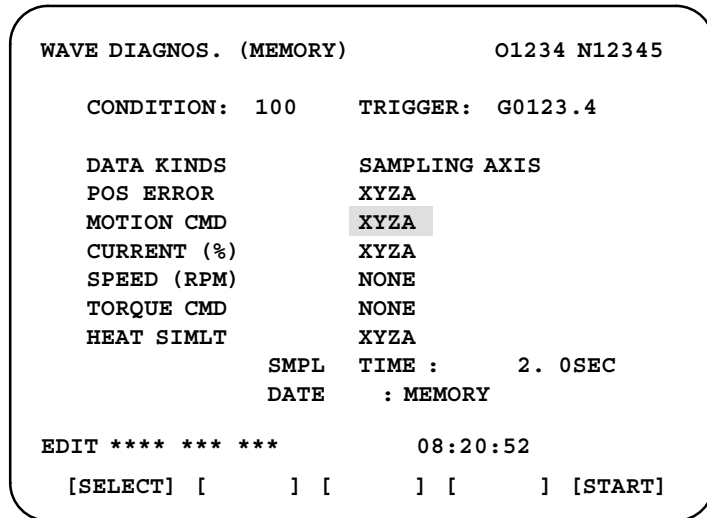

- (3) The configuration of the operation selection soft keys is as follows:

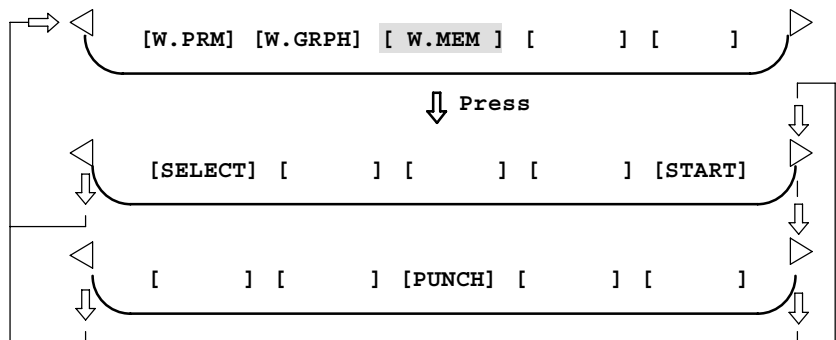

Fig. 1.10.4 Soft keys

- (4) Using the cursor, set the necessary data items. To set the sampling axes, position the cursor to the data item to be set, enter the names of the axes for which data will be sampled for that data item, then press [SELECT] or . The axis names are displayed to the right of the data items.

Example) XYZ + [SELECT] or

- (5) Once the sampling axes have been selected, the sampling period for each axis is displayed. Subsequently pressing the [START] soft key starts data sampling.

**CAUTION**

- 1 Data items for which ***** is displayed cannot be set.
- 2 To change the sampling axes, enter new axis names then press the [SELECT] soft key. Pressing the [SLELCT] soft key without entering an axis name results in no sampling axis being set.
- 3 If the sampling axes are changed during data sampling, data sampling is stopped. In this case, press the [START] soft key to restart data sampling for the new sampling axes.
- 4 Initially, no sampling axis is set.
- 5 When the sixth-type sampling data is spindle load meter data (parameter No. 3121 = 1), set the axis name S.

- **Storage data parameters**

(1) Storage stop condition

100: Stops data storage upon the issue of a servo alarm.

101: Stops data storage upon the issue of a servo alarm or the detection of the rising edge of the trigger signal.

102: Stops data storage upon the issue of a servo alarm or the detection of the falling edge of the trigger signal.

The maximum stored data width is 32760 ms. If the storage stop condition is not satisfied within 32760 ms, data is overwritten, starting with the oldest data.

Parameter No. 3120 can be used to delay data storage being stopped by a specified period (ms), after the issue of a servo alarm.

(2) Trigger: Set the PMC address and bit for the signal used to trigger the stopping of data storage, when 101 or 102 is set for the stop condition.

Example) G0007.2: ST signal

(3) Data type: The following table lists the types of data for which a waveform can be displayed.

| Data type | Description | Units |
|-------------|--|---------------------------------|
| POS ERROR | Servo error (8 ms) for the n-th axis | Pulses (detection units) |
| MOTION CMD | Pulse distribution for the n-th axis | Pulses (input increments) |
| CURRENT (%) | Torque for the n-th axis | % (relative to maximum current) |
| SPEED (RPM) | Actual speed for the n-th axis | min ⁻¹ |
| TORQUE CMD | Command current for the n-th axis | % (relative to maximum current) |
| HEAT SIMLT | Thermal simulation data for the n-th axis (when the parameter No.3121 is set to 0.) | % (OVC alarm ratio) |
| LOAD METER | Load meter for the n-th spindle (when the parameter No.3121 is set to 1.) | % (relative to maximum output) |

NOTE

With parameter No. 3121, choose whether the sixth-type sampling data is thermal simulation data or spindle load meter data. When spindle load meter is selected, the spindle data of the first axis is stored with each path.

- (4) Sampling axis: The axes along which data will be sampled are displayed.
- (5) Sampling period: The sampling period for each axis is displayed.
- (6) Date of storage: While data is being sampled, MEMORY blinks in this field. When data sampling stops, the date at that point appears in this field.

**1.10.5
Outputting Waveform
Diagnosis Data
(Storage Type)**

Waveform diagnosis data of servo alarm format can be output to an I/O device, as follows:

- 1) Select EDIT mode.
- 2) Press the  key, then display the WAVE DIAGNOS. (MEMORY) screen.
- 3) Press the [W.MEM], \triangleright , [PUNCH], and [EXEC] soft keys, in this order.

For details of input/output to/from the Handy File, see “Output to Handy File,” below.

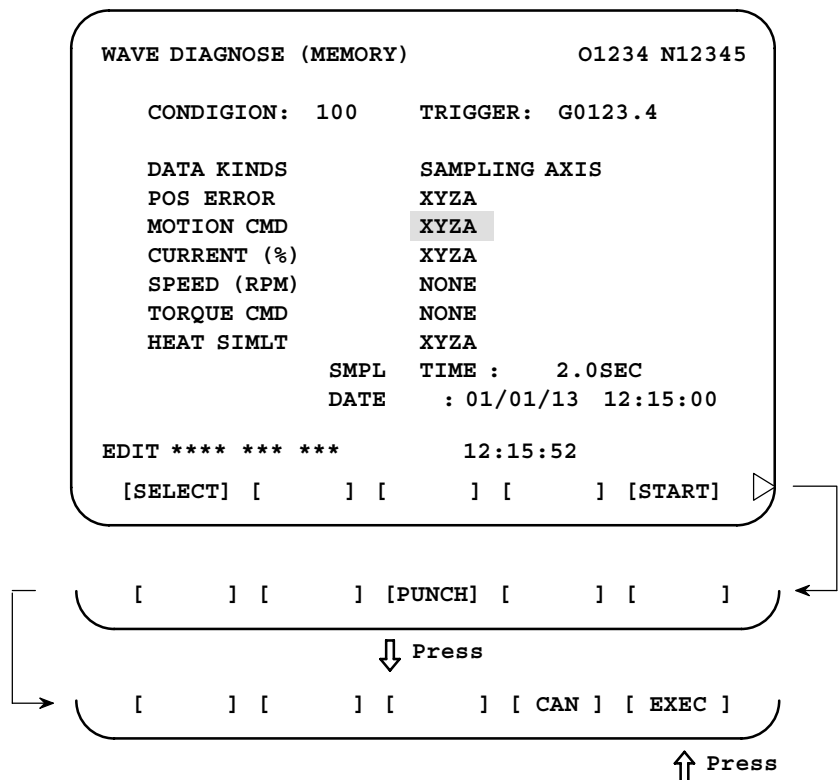

● Output to Handy File



- 1) Select EDIT mode.
- 2) Press the  key, then display the WAVE DIAGNOS. (MEMORY) screen.
- 3) Open the write protect tab on the cassette.
- 4) Press the [W.MEM], \triangleright , [PUNCH], and [EXEC] soft keys, in this order.

The waveform diagnosis data is output to a file named WAVE DIAGNOS, to which the number of the last file is assigned.

If a file named WAVE DIAGNOS already exists in the cassette, P/S alarm 86 is issued. A cassette can contain only one file for waveform diagnosis data. If the existing WAVE DIAGNOS file contains unnecessary waveform diagnosis data of servo alarm format, delete that file before attempting to output new data. The procedure for deleting a file is described later.

● Directory display

The directory in the cassette is displayed by means of the following procedure:

- 1) Select EDIT mode.
- 2) Press the  function key to select the program screen.
- 3) Press the continuous menu key , then press [FLOPPY].
- 4) Press page key .

The directory is displayed.

● Deleting a file

A file stored on a cassette is deleted by means of the following procedure:

- 1) Select EDIT mode.
- 2) Press the  function key to select the program screen.
- 3) Set the write protect switch on the cassette to enable writing.
- 4) Press [FLOPPY].
- 5) Press [DELETE].
- 6) Enter the file number, then press [F SET].
- 7) Press [EXEC].

The file corresponding to the specified file number is deleted. The number of each file subsequent to the deleted file is decremented by one.

● **Output format**

In the servo alarm format, the header, date and time, selected axes, and waveform diagnosis data are output in this order. Data items are identified by ten identifier words. Output data other than the identifier words varies with the data type.

| | |
|--------------------|------------------------------|
| T(identifier word) | |
| T0 | : Header |
| T60 | : Positional deviation |
| T61 | : Move command |
| T62 | : Actual current |
| T63 | : Actual speed |
| T64 | : Command current |
| T65 | : Thermal simulation |
| T66 | : Load meter for the spindle |
| T68 | : Selected axes |
| T69 | : Date and time |

1) Header

| | | | | | | | | | | | | | | | |
|--------------|---|---|---|---|---|---|--|---|---|---|---|---|---|---|---|
| T | 0 | C | W | A | V | E | | D | I | A | G | N | O | S | ; |
| C: Data word | | | | | | | | | | | | | | | |

2) Data word

| | | | | | | | | | | | | | | | | | | | |
|--|---|---|---|---|---|---|---|---|---|---|---|---|---|---|---|---|---|---|---|
| T | 6 | 9 | D | * | * | * | * | * | * | , | * | * | * | * | * | * | ; | | |
| D*..*: Data Example: 12:14 59 seconds on June 23, 2002 | | | | | | | | | | | | | | | | | | | |
| T | 6 | 9 | D | 2 | 0 | 0 | 2 | 0 | 6 | 2 | 3 | , | 1 | 2 | 1 | 4 | 5 | 9 | ; |

3) Selected axes

| | | | | | | | | | | | | | | | | |
|---|---|---|---|---|---|---|---|---|---|---|---|---|----|---|---|---|
| T | 6 | 8 | P | * | * | D | * | * | , | * | * | , | to | * | * | , |
| P0: Positional deviation P1: Actual speed P2: Move command P3: Command current P4: Actual current P5: Thermal simulation D*.. *: Axis number (1 to 4) | | | | | | | | | | | | | | | | |

4) Waveform diagnosis data

| | | | | | | | | | | | | | | | | | | |
|---|---|---|---|---|---|---|---|---|---|---|---|---|--|----|---|---|---|--|
| T | 6 | 0 | D | * | * | , | * | * | , | * | * | , | | to | * | * | , | |
| T | 6 | 1 | D | * | * | , | * | * | , | * | * | , | | to | * | * | , | |
| T | 6 | 2 | D | * | * | , | * | * | , | * | * | , | | to | * | * | , | |
| T | 6 | 3 | D | * | * | , | * | * | , | * | * | , | | to | * | * | , | |
| T | 6 | 4 | D | * | * | , | * | * | , | * | * | , | | to | * | * | , | |
| T | 6 | 5 | D | * | * | , | * | * | , | * | * | , | | to | * | * | , | |
| T | 6 | 6 | D | * | * | , | * | * | , | * | * | , | | to | * | * | , | |

D*..*: Waveform diagnosis data x number of axes

NOTE

- 1 Records are classified into header records and data records.
- 2 “%” is used as an end-of-record code.
- 3 Each record starts with an identifier and ends with an end-of-block code.
- 4 Either the ISO or EIA code system is used.
- 5 The output code type is specified with parameter ISO (bit 1 of No. 0100). For ISO code, parameter NCR (bit 3 of No. 0100) is used to specify whether the end-of-block code is <LF> only, or a sequence of <LF> <CR> <CR>.
- 6 Parameter NFD (bit 7 of No. 01X1, where X is the channel number) is used to specify whether a feed code is output before and after the data.
- 7 No identifier word is output for a data item for which no axis is selected.
- 8 The above file corresponds to a paper tape of about 200 m in length.



**1.10.6
Notes**

- (1) Once the storage is full, the oldest data is overwritten.
- (2) Stored-type waveform diagnostic data is not lost, even when the power is turned off.
- (3) The waveform diagnostic function is disabled when parameter SGD (bit 0 of No. 3112) is set to 0.
- (4) Set the correct date and time using the setting screen.

1.11 OPERATING MONITOR

Load meter of the servo axis and the serial spindle and the speed meter can be displayed.

1.11.1 Display Method

1. Set a parameter to display operating monitor. (Bit 5 (OPM) of parameter No.3111)
2. Press the  key to display the position display screen.
3. Press continuous menu key , then soft key [MONI] is displayed.
4. Press the soft key [MONI], then the operating monitor screen is displayed.

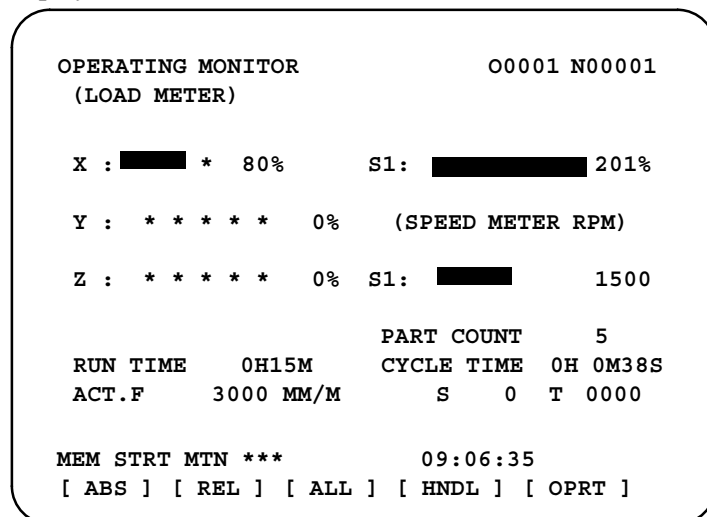

CAUTION

- 1 The bar graph for the load meter shows load up to 200%.
- 2 The bar graph for the speed meter shows the ratio of the current spindle speed to the maximum spindle speed (100%). Although the speed meter normally indicates the speed of the spindle motor, it can also be used to indicate the speed of the spindle by setting bit 6. (OPS) of parameter 3111 to 1.
- 3 The servo axes for their load meters are displayed are set to parameter No. 3151 to 3. If parameters 3151 to 3153 are all zero, the load meter of the basic axes are displayed.
- 4 For color display, the bar of the load meter that exceed 100% shows purple color.

1.11.2 Parameters

| | | #7 | #6 | #5 | #4 | #3 | #2 | #1 | #0 |
|-----|------|----|-----|-----|----|----|----|----|----|
| DGN | 3111 | | OPS | OPM | | | | | |

[Data type] Bit

OPM Operating monitor display is:

0 : Disabled

1 : Enabled

OPS The speed meter on the operating monitor screen displays:

0 : Spindle motor speed

1 : Spindle speed

| | | |
|-----|------|--|
| DGN | 3151 | Axis number for which the first servo motor load meter is displayed |
| DGN | 3152 | Axis number for which the second servo motor load meter is displayed |
| DGN | 3153 | Axis number for which the third servo motor load meter is displayed |
| DGN | 3154 | Axis number for which the fourth servo motor load meter is displayed |







[Data type] Byte

[Valid data range] 0, 1, ... number of controlled axes











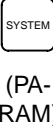

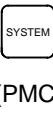

These parameters specify the numbers of the axes for which load meters for servo motors are to be displayed. Up to four load meters can be displayed. Set 0 for those axes for which no load meter is to be displayed.

1.12 LIST OF OPERATIONS







Reset

| Function | Data protection key | Parameter write=1 | Mode | Function button | Operation |
|---------------------------------|---------------------|-------------------|-------------|---|--|
| Resetting run hour | | | – |  | [(OPRT)][RUNPRE]→[EXEC] |
| Resetting no. of machined parts | | | – |  | [(OPRT)][PTSPRE]→[EXEC] |
| Resetting OT alarm | | | At Power ON | – |  and  |
| Resetting alarm 100 | | | – | – |  and  |











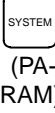

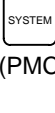



Registration from MDI

| Function | Data protection key | Parameter write=1 | Mode | Function button | Operation |
|---|---------------------|-------------------|---------------|---|--|
| Inputting parameters | | ○ | MDI or E.Stop |  | Parameter no.→[NO.SRH]→Data→  → PWE =0 →  |
| Inputting offset values | OFF | | – |  | Offset number→[NO.SRH]→Offset value→  |
| Inputting setting data | OFF | | MDI |  | Setting no.→[NO.SRH]Data→  |
| Input of PMC parameters, counter and data table | OFF or ○ | | MDI or E.Stop |  | [PMCPRM]→[COUNTR] or [DATA]→Data→  |
| Inputting PMC parameters (Timer, keep relay) | | ○ | MDI or E.Stop |  | [PMCPRM]→[TIMER] or [KEEPRL]→Data→  |
| Tool length measurement | | | JOG |  →  |  (Display of relative coordinate)<AXIS>→ [ORIGIN] →  →Jog the tool to measuring position Offset no.→[NO.SRH]→<AXIS>→[IN.P.C] |







Input/Output with FANUC Cassette

| Function | Data protection key | Parameter write=1 | Mode | Function button | Operation |
|---------------------|---------------------|-------------------|------|---|--|
| Heading a file | | | EDIT |  | N →File no.→[]→[F SRH]→[EXEC] |
| Deleting a file | OFF | | EDIT |  | N →File no.→[]→[DELETE]→[EXEC] |
| Collating a program | | | EDIT |  | Heading a file→  →Program number→[(OPRT)] →[]→[READ]→[EXEC] |

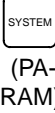





Inputting From FANUC Cassette

| Function | Data protection key | Parameter write=1 | Mode | Function button | Operation |
|---------------------------|---------------------|-----------------------|----------------|---|--|
| Inputting parameters | | <input type="radio"/> | EDIT or E.Stop |  | [(OPRT)]→[]→[READ]→[EXEC] |
| Inputting PMC parameters | | <input type="radio"/> | E.Stop |  | []→[I/O]→(CANNEL NO) 1  → (DEVICE NAME) [FDCAS]→(KIND OF DATA) [PARAM]→[READ]→(FILE NO) File no.  →[EXEC] |
| Inputting offset values | OFF | | EDIT |  | (Heading a file no.)→[(OPRT)]→[]→[READ]→[EXEC] |
| Registering a program | OFF | | EDIT |  | N →File no.→  →[]→[READ]→[EXEC] |
| Inputting macro variables | OFF | | EDIT |  | N →File no.→  →[]→  → Program no. → [READ]→[EXEC] |
| | | | MEMORY |  | <START> (Note) After loading into the program by assigning an appropriate program number, this function performs execution in MEM mode. Then, it deletes the program. |

Output to FANUC Cassette

| Function | Data protection key | Parameter write=1 | Mode | Function button | Operation |
|---------------------------|---------------------|-------------------|------------------------|---|--|
| Output of parameter | | | EDIT or Emergency Stop |  | [(OPRT)]→[▶]→[PUNCH]→[EXEC] |
| Output of PMC parameter | | | EDIT |  | [▶]→[I/O]→(CHANNEL NO) <input type="text" value="1"/> <input type="text" value="INPUT"/> →(DEVICE NAME) [FDCAS] →(KIND OF DATA) [PARAM] → [WRITE] → (FILE NO) <input type="text" value="-"/> <input type="text" value="1"/> <input type="text" value="INPUT"/> →[EXEC] |
| Output of offset | | | EDIT |  | [(OPRT)]→[▶]→[PUNCH]→[EXEC] |
| Output of all programs | | | EDIT |  | <input type="text" value="O"/> →-9999→[▶]→[PUNCH]→[EXEC] |
| Output of one program | | | EDIT |  | <input type="text" value="O"/> →Program no.→[▶]→[PUNCH]→[EXEC] |
| Output of macro variables | | | EDIT |  | [▶]→[MACRO]→[(OPRT)]→[▶]→[PUNCH]→[EXEC] |

Search

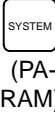
| Function | Data protection key | Parameter write=1 | Mode | Function button | Operation |
|-------------------------------|---------------------|-------------------|----------------|---|--|
| Searching a program number | | | MEMORY or EDIT |  | <input type="text" value="O"/> →Program no.→[O SRH] |
| Searching a sequence number | | | MEMORY |  | Program no. search→ <input type="text" value="N"/> →Sequence number→[NSRH] |
| Searching an address word | | | EDIT |  | Data to be searched→[SRH↑] or [SRH↓] or <input type="text" value="↑"/> <input type="text" value="↓"/> (cursor key) |
| Searching an address only | | | EDIT |  | Address to be searched [SRH↑] or [SRH↓] or <input type="text" value="↑"/> <input type="text" value="↓"/> (Cursor key) |
| Searching an offset number | | | - |  | Offset no.→[NO.SRH] |
| Searching a diagnostic number | | | - |  | Diagnostic number→[NO.SRH] |
| Searching a parameter number | | | - |  | Parameter no.→[NO.SRH] |

Edit

| Function | Data protection key | Parameter write=1 | Mode | Function button | Operation |
|---------------------------------|---------------------|-------------------|------|-----------------|---|
| Display of memory capacity used | | | EDIT | | [LIB] |
| Deleting all programs | OFF | | EDIT | | → -9999 → |
| Deleting a program | OFF | | EDIT | | → Program no. → |
| Deleting several blocks | OFF | | EDIT | | → Sequence no. → (Deleted up to a block with a specified sequence no.) |
| Deleting a block | OFF | | EDIT | | → |
| Deleting a word | OFF | | EDIT | | Searching a word to be deleted → |
| Changing a word | OFF | | EDIT | | Searching a word to be changed → New Data → |
| Inserting a word | OFF | | EDIT | | Searching a word immediately before a word to be searched → New Data → |











Collation

| Function | Data protection key | Parameter write=1 | Mode | Function button | Operation |
|------------------|---------------------|-------------------|------|-----------------|----------------------------------|
| Collating memory | ON | | EDIT | | [(OPRT)] → [▶] → [READ] → [EXEC] |

Playback

| Function | Data protection key | Parameter write=1 | Mode | Function button | Operation |
|------------------|---------------------|-------------------|--------------------------------|-----------------|--|
| Input of NC data | OFF | | TEACH -IN JOG/ HANDLE | | Jog the machine → , or → → NC data → → → |

Clear









| Function | Data protection key | Parameter write=1 | Mode | Function key | Operation |
|---|---------------------|-----------------------|-------------|--------------|--|
| Memory all clear | | | At power ON | |  AND  |
| Parameter/offset clear | | <input type="radio"/> | At Power ON | |  |
| Clearing a program | | <input type="radio"/> | At Power ON | |  |
| Program under edition at power off(PS101) | | | – | |  AND  |
| PMC RAM * | | | At Power ON | |  AND  (O) |
| Additional SRAM area clear | | | At Power ON | |  (O) AND  |

* PMC ladder program is not cleared in FROM.



Manual operation

| Function | KEY SW | PWE =1 | Mode | Function key | Operation |
|-------------------------------|--------|--------|------|--------------|---|
| Manual reference point return | | | JOG | | Turn on Reference point return switch → Turn on +X, -X, +Z, or -Z → Reference point return switch LED lit. |
| Jog feed | | | JOG | | Turn on +X, -X, +Z, or -Z → Use JOG FEEDRATE to set jog feedrate → Press Rapid traverse button, if required. |
| Incremental feed | | | INC | | Use Move distance selection switch to select move distance → Turn on +X, -X, +Z, or -Z → Press Rapid traverse button, if required. |
| Manual handle feed | | | HND | | Use Axis selection switch to select axis to be operated → Use Handle magnification selection to select magnification → Turn manual pulse generator. |



Display

| Function | KEY SW | PWE =1 | Mode | Function key | Operation |
|--|--------|--------|------------|---|---|
| Amount of program memory in use | | | EDIT |  | [DIR] |
| Command value display | | | MEM or MDI |  | Command value being executed, and previously specified modal value |
| | | | | | [CURRNT] |
| | | | | | Command value being executed, and next command value to be executed |
| | | | | | [NEXT] |
| | | | | | Command value entered from MDI, and previously specified modal value |
| | | | | | [MDI] |
| | | | | | Program in memory being executed |
| | | | | | [PRGRM] |
| Current-position display | | | |  | Representation of the position in the workpiece coordinate system |
| | | | | | [ABS] |
| | | | | | Representation of the position in the relative coordinate system |
| | | | | | [REL] |
| | | | | | General position indication |
| [ALL] | | | | | |
| Alarm display | | | — |  | [ALARM] when an alarm condition has occurred. |
| Alarm history display | | | |  | [HISTORY] |
| Screen erase | | | — | — | Press the  and function keys simultaneously. The function key causes re-display. |
| Screen switching between NC and loader | | | | |  and  |





Graphics functions (T series)

| Function | KEY SW | PWE =1 | Mode | Function key | Operation |
|-------------------|--------|--------|------|---|--|
| Parameter setting | | | |  | [G.PRM] |
| Tool path drawing | | | |  | Select a graphics drawing screen. |
| | | | | | [GRAPH] |
| | | | | | Begins and ends drawing. |
| | | | | | During automatic operation or manual operation |
| | | | | | Erase a drawing screen. |
| | | | | | [[OPRT] → [ERASE] |
| | | | | | Enlarge graphics. |
| [ZOOM] | | | | | |





NOTE



For the small-size MDI, read the  function key in this table as the  function key.

Graphics function (M series)





| Function | KEY SW | PWE =1 | Mode | Function key | Operation |
|--------------------------------|--------|--------|------|---|--|
| Parameter setting | | | |  | [PARAM] |
| Tool path drawing | | | |  | Select a graphics drawing screen. |
| | | | | | [GRAPH] |
| | | | | | Begin and end drawing. |
| | | | | | During automatic operation or manual operation |
| Tool path diagram data setting | | | |  | Press the  key several times → Display "PATH GRAPHIC (PARAMETER)" screen → [PARAM] → Enter numerals using numeric keys →  |

| Function | KEY SW | PWE =1 | Mode | Function key | Operation | |
|--|--------|--------|------|--------------|---|----------------------|
| Tool path drawing | | | MEM | GRAPH | Press the GRAPH key several times → Display “PATH GRAPHIC (PARAMETER)” screen → [EXEC] → [(OPRT)] → [AUTO] or [START] | |
| | | | | | Suspend drawing | |
| | | | | | [STOP] | |
| | | | | | Suspend drawing | Execute. |
| | | | | | | [START] |
| Draw starting at the top of the program. | | | | | | |
| [REWIND] → [START] | | | | | | |
| Enlarging part of the tool path drawing | | | | GRAPH | Press the GRAPH key several times → Display “PATH GRAPHIC (PARAMETER)” screen → [SCALE] → [(OPRT)][←][→][↓][↑] → P C or M # → [EXEC] | |
| Current-tool position mark display | | | | GRAPH | Press the GRAPH key several times → Display “SOLID GRAPHIC (PARAMETER)” screen → [POS] | |
| Machining profile drawing data setting | | | | GRAPH | Press the GRAPH key several times → “SOLID GRAPHIC (PARAMETER)” screen → Enter numerals using numeric keys → INPUT | |
| Blank figure drawing | | | | GRAPH | Press the GRAPH key several times → “SOLID GRAPHIC (PARAMETER)” screen → [BLANK] → [(OPRT)] → [ANEW] → [+ ROT][– ROT][+TILT][–TILT] | |
| Machining profile drawing | | | MEM | GRAPH | Press the GRAPH key several times → “SOLID GRAPHIC (PARAMETER)” screen → [EXEC] → [(OPRT)] → [A.ST] or [F.ST] | |
| | | | | | Suspend drawing | |
| | | | | | [STOP] | |
| | | | | | After drawing is suspended | Execute. |
| | | | | | | [A.ST] or [F.ST] |
| Display the start of part program. | | | | | | |
| [REWIND] → [A.ST] or [F.ST] | | | | | | |



| Function | KEY SW | PWE =1 | Mode | Function key | Operation |
|--|--------|--------|------|---|--|
| Re-drawing of "SOLID GRAPHIC (PARAMETER)" in a different orientation | | | |  | Press the  key several times → "SOLID GRAPHIC (PARAMETER)" screen → [REVIEW] → [(OPRT)] → [ANEW] → [+ ROT][- ROT][+TILT][-TILT] |
| 3-plane drawing | | | |  | Press the  key several times → "SOLID GRAPHIC (PARAMETER)" screen → [▶] → [3-PLN] → [(OPRT)] → [◯] [←][→][↑][↓] |

NOTE
 For the small-size MDI, read the  function key in this table as the  function key.

Help function

| Function | KEY SW | PWE =1 | Mode | Function key | Operation |
|--|--------|--------|------|---|---|
| Initial menu screen display | | | |  |  |
| Alarm detail screen display | | | |  | [ALARM] → Alarm No. → [SELECT] |
| Operation method screen display | | | |  | [OPERAT] → Operation method item No. → [SELECT] |
| Parameter table-of-contents screen display | | | |  | [PARAM] |

Self-diagnosis function

| Function | KEY SW | PWE =1 | Mode | Function key | Operation |
|-------------------------------|--------|--------|------|---|--|
| Self-diagnosis screen display | | | |  | [DGNOS] ↓ 1.   page switch keys 2. Diagnosis data No. → [NO.SRH] |

Boot

| Function | KEY SW | PWE =1 | Mode | Function key | Operation |
|---|--------|--------|---------------|--------------|--|
| System monitor screen display | | | Power-on time | — |  and a soft key at its left |
| Reading file from memory card | | | | | Place the cursor at 1. SYSTEM DATA LOADING on the system monitor screen → [SELECT] → Place the cursor at the target file → [SELECT] → [YES] |
| Listing files in flash ROM and displaying detail screen | | | | | Place the cursor at 2. SYSTEM DATA CHECK on the system monitor screen → [SELECT] → Place the cursor at the target item → [SELECT] |
| Deleting file from flash ROM | | | | | Place the cursor at 3. SYSTEM DATA DELETE on the system monitor screen → [SELECT] → Place the cursor at the target file → [SELECT] → [YES] |
| Outputting file from flash ROM to memory card | | | | | Place the cursor at 4. SYSTEM DATA SAVE on the system monitor screen → [SELECT] → Place the cursor at the target file → [SELECT] → [YES] |
| Transferring contents between SRAM and memory card in batch | | | | | Place the cursor at 5. SRAM DATA BACKUP on the system monitor screen → [SELECT] – Batch output to memory card Place the cursor at 1. SRAM BACK UP → [SELECT] → [YES] – Batch input from memory card Place the cursor at 2. RESTORE SRAM → [SELECT] → [YES] |
| Deleting file from memory card | | | | | Place the cursor at 6. MEMORY CARD FILE DELETE on the system monitor screen → [SELECT] → Place the cursor at the target file → [SELECT] → [YES] |
| Memory card formatting | | | | | Place the cursor at 7. MEMORY CARD FORMAT on the system monitor screen → [SELECT] → [YES] |
| Exiting system monitor | | | | | Place the cursor at 10. END on the system monitor screen → [SELECT] → [YES] |

Reference

If no soft key is available as with a touch panel, use the numeric keys on the MDI keypad.

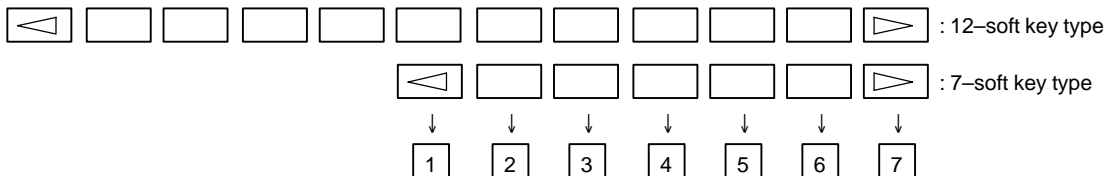

1.13 WARNING SCREEN DISPLAYED WHEN AN OPTION IS CHANGED

- **Warning screen**

This CNC displays a warning screen when the configuration of the options using the SRAM area is changed. The data for the function indicated on the screen is cleared the next time the system is turned on.

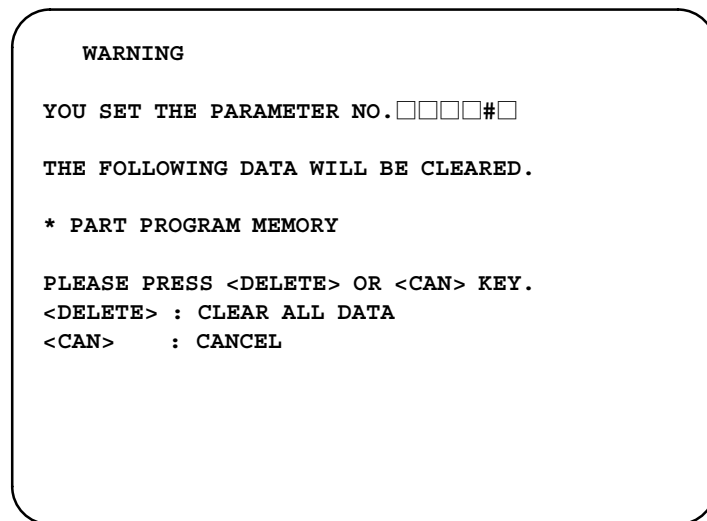

NOTE

Mark* varies with the parameter settings. Two or more function names may be displayed.

- **Allocation error screen**

When an option which uses the SRAM area is added, the system software may require more SRAM than is currently installed in the system. In this case, an allocation error screen appears the first time the system is turned on after the addition of the option, thus restoring the state existing before the addition.

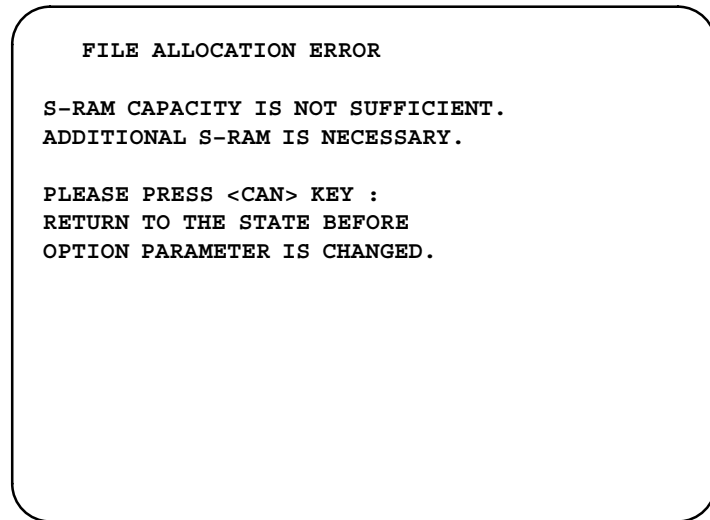
**NOTE**



When replacing SRAM, perform all memory clear.

(RESET + DELETE)

1.14 WARNING SCREEN DISPLAYED WHEN SYSTEM SOFTWARE IS REPLACED (SYSTEM LABEL CHECK ERROR)

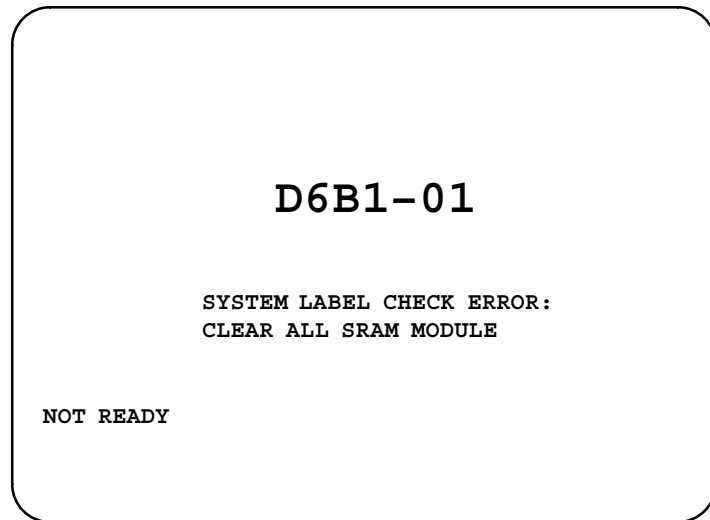
When an attempt is made to turn on the power to the CNC after replacing the system software, the screen shown below is displayed, and the system is not started if the replacing new system software is not compatible with the replaced system software.



In this case, perform memory all clear (by holding down the  and  MDI keys then turning on the power) or reinstall the original system software.

1.15 MAINTENANCE INFORMATION SCREEN



The maintenance information screen is provided to record the history of maintenance performed by a service person of FANUC or machine tool builder.

The screen has the following features:

- MDI alphabetical input is allowed.
- The recording screen can be scrolled in units of lines.
- Edited maintenance information can be read and punched.
- The screen can be saved in flash ROM.

1.15.1 Screen Display and Operation

• Screen display

1. Press the  function key.
2. Press the continuous menu key  several times. [M-INFO] soft key appears.
3. Press the [M-INFO] soft key. The maintenance information screen appears.

When selected, the maintenance screen shows the latest information.

The recording screen has an input area of 40 characters by 11 lines.

The status (mode, number of empty character spaces, cursor line, column number) is displayed at the bottom of the screen.

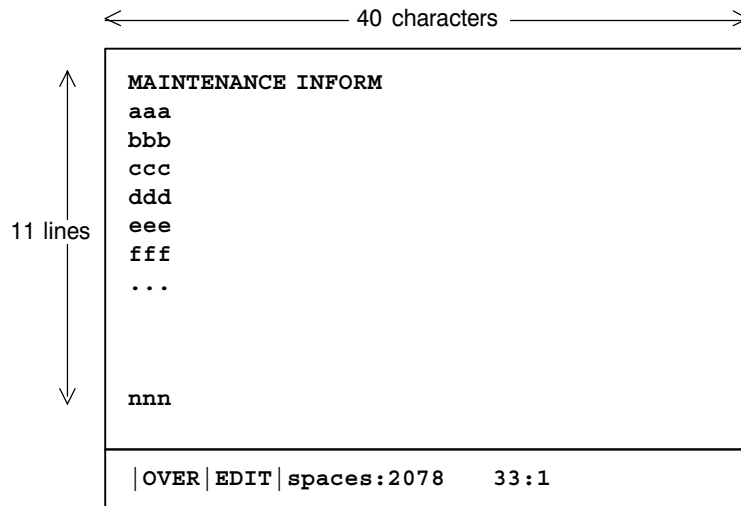

Status display

- OVER/INSERT : -- OVER : Overwrite mode ; INSERT: Insert mode
- EDIT/VIEW : --- EDIT : Editing allowed ; VIEW : Editing inhibited
- Number of empty character spaces
- Current cursor line
- Current cursor column

● Screen operation





The maintenance information screen has view mode and edit mode, which are selected by pressing the [END] or [EDIT] soft key.

Initially, view mode is selected. To start editing, select edit mode by pressing the [(OPRT)] and [EDIT] keys. When the editing is completed, press the [END] key. Then, select [STORE] or [IGNORE]. Unless [STORE] is selected, the edited data will be lost at next power-up.

To scroll the screen showing the recorded information, press a cursor key or page key on the MDI panel.

The following keys are used for editing (character input) and viewing:

Operation table

| Mode | Key | Description |
|---|---|---|
| View | Soft keys [EDIT] [JUMP] | Allows editing. Displays the beginning or the end. |
| | Cursor key | Scrolls the screen up or down. |
| | Page key | Scrolls the screen up or down in units of whole screens. |
| Edit | Soft keys [END] | Ends editing. Select whether to store the edited data. |
| | [ALLDEL] | Clears all maintenance information. (This key is enabled when the MDC bit (bit 3 of parameter 3118) is set to 1.) |
| | [I/O] | Reads or punches the maintenance information. |
| | [JUMP] | Moves the cursor to the beginning or end. |
| | Cursor key | Moves the cursor position up or down. |
| | Page key | Scrolls the screen up or down in units of whole screens. |
| | Alphanumeric/special character keys | Allows alphabetical, numeric, or special character input. |
| |  key | Selects either insert mode or overwrite mode. |
| |  key | Deletes a single character. |
| |  key | Deletes a single character before the cursor position. |
|  key | Starts a new line. | |

Operation of the soft keys

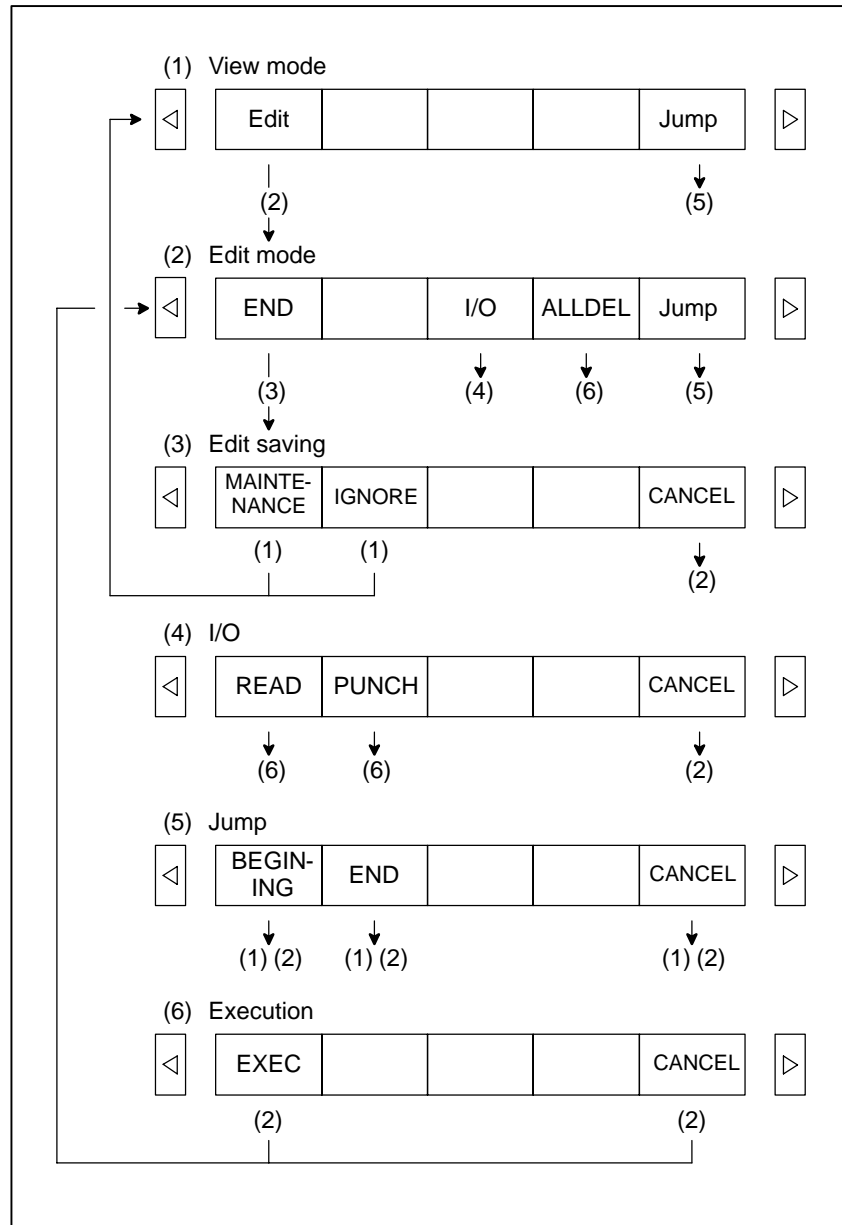

1.15.2 Maintenance Information Input/Output

The maintenance information can be read and punched.
When the maintenance information is input from or output to a memory card, a file name MAINTINF.DAT is used.

(1) Format

```
.....%%  
|----- Data -----|
```

(2) Reading

When a MAINTINF.DAT file generated in the format shown above is read, the data is added at the end of the existing maintenance information.

NOTE

- 1 A TAB code is converted to one to four blanks, depending on the input position.
- 2 80h to 90h and E0h to EBh are assumed as prefix codes of double-byte characters. Reading these codes alone is inhibited.
- 3 Control codes (00H to 1FH) except TAB and LF are discarded in reading.
- 4 %% cannot be input.

(3) Punching

All maintenance information is output in the format shown above.

1.16 COLOR SETTING SCREEN (8.4" COLOR LCD)

- **Setting FANUC standard color scheme 1 (new FANUC standard color scheme)**

When VGA screen display is selected (NVG bit (bit 7 of parameter 3119) is set to 0), the color scheme of the VGA screen can be set on the color setting screen.

If all standard color data parameters (No. 6561 to 6595) of color scheme 1 are "0", turning the power off and on again with the NDC parameter (bit 6 of parameter No. 13101) set to "1" selects FANUC standard color scheme 1 (new FANUC standard color scheme) for color setting (color palette values).

The following table summarizes what FANUC standard color scheme 1 (new FANUC standard color scheme) is like.

| Color setting number | Red | Green | Blue |
|----------------------|-----|-------|------|
| 1 | 8 | 0 | 0 |
| 2 | 0 | 0 | 0 |
| 3 | 5 | 5 | 5 |
| 4 | 15 | 15 | 0 |
| 5 | 15 | 0 | 15 |
| 6 | 1 | 6 | 6 |
| 7 | 0 | 0 | 0 |
| 8 | 4 | 11 | 9 |
| 9 | 0 | 11 | 11 |
| 10 | 4 | 11 | 9 |
| 11 | 12 | 11 | 11 |
| 12 | 15 | 15 | 15 |
| 13 | 12 | 11 | 11 |
| 14 | 4 | 4 | 4 |
| 15 | 11 | 11 | 11 |

Note) : Indicates a difference between FANUC standard color schemes 1 and 2.

- **Setting FANUC standard color scheme 2 (former FANUC standard color scheme)**

If all standard color data parameters (No. 6561 to 6595) of color scheme 1 are “0”, turning the power off and on again with the ODC parameter (bit 7 of parameter No. 13101) set to “1” selects FANUC standard color scheme 2 (former FANUC standard color scheme) for color setting (color palette values).

The following table summarizes what FANUC standard color scheme 2 (former FANUC standard color scheme) is like.

| Color setting number | Red | Green | Blue |
|----------------------|-----|-------|------|
| 1 | 8 | 0 | 0 |
| 2 | 0 | 8 | 0 |
| 3 | 8 | 8 | 0 |
| 4 | 15 | 15 | 0 |
| 5 | 15 | 0 | 15 |
| 6 | 0 | 8 | 8 |
| 7 | 3 | 1 | 1 |
| 8 | 0 | 0 | 15 |
| 9 | 0 | 11 | 11 |
| 10 | 15 | 15 | 15 |
| 11 | 10 | 9 | 9 |
| 12 | 15 | 15 | 15 |
| 13 | 12 | 11 | 11 |
| 14 | 4 | 4 | 4 |
| 15 | 12 | 11 | 11 |

- **Parameters**

| | #7 | #6 | #5 | #4 | #3 | #2 | #1 | #0 |
|-------|-----|-----|----|----|----|----|----|----|
| 13101 | ODC | NDC | | | | | | |

[Data type] Bit

ODC For the color LCD of FANUC Series 16i/18i/21i/0i-MODEL B, the VGA screen display colors (color palette values) are:

0 : Not changed.

1 : Set to FANUC standard color scheme 2 (former FANUC standard color scheme).

NDC For the color LCD of FANUC Series 16i/18i/21i/0i-MODEL B, the VGA screen display colors (color palette values) are:

0 : Not changed.

1 : Set to FANUC standard color scheme 1 (new FANUC standard color scheme).

After the ODC parameter is set to “1”, turning the power off and on again allows the ODC parameter to be automatically reset to “0”.



After the NDC parameter is set to “1”, turning the power off and on again allows the NDC parameter to be automatically reset to “0”.

If all standard color data parameters (No. 6561 to 6595) of color scheme 1 are “0”, setting the ODC or NDC parameter to “1” allows color settings to be changed.

● **Notes**

- (1) This function is valid for screens created using the macro executor. If the macro executor program (conversational macro program) already specifies colors (color palette values), however, these colors are valid.
- (2) This function is invalid:
 - 1) For the monochrome LCD
 - 2) If the NVG parameter (bit 7 of parameter No. 3119) is “1”
 - 3) For the MDI virtual keys
 - 4) For display links

**1.16.1
Screen Display**

1. Press the  function key.
2. Press the continuous menu key  several times. The [COLOR] soft key appears.
3. Press the [COLOR] soft key. The color setting screen appears.

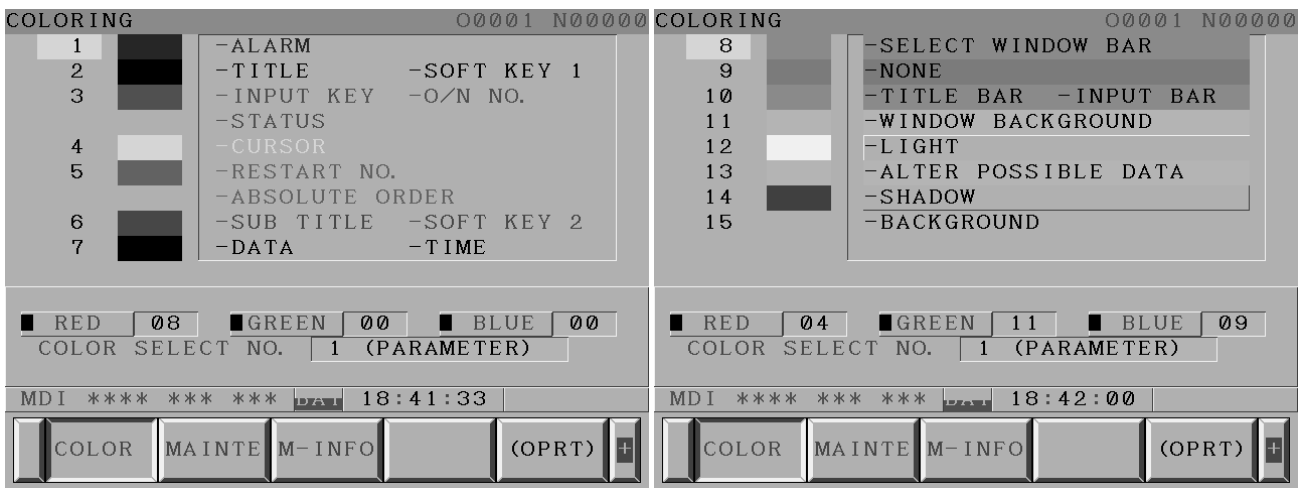

**1.16.2
Color Setting**

● **Changing a color (color palette value)**

1. Press the [(OPRT)] soft key. The following operation soft keys appear.

| | | | | | | |
|--|-----|-------|------|--------|------|---|
| | RED | GREEN | BLUE | BRIGHT | DARK | + |
|--|-----|-------|------|--------|------|---|

2. Move the cursor to the color number corresponding to the color palette value to be changed.
The current color palette values of individual color elements are displayed.

3. Select a desired color element by pressing the **[RED]**, **[GREEN]**, or **[BLUE]** operation soft key.

Two or more color elements can be simultaneously selected.

Each time the **[RED]**, **[GREEN]**, or **[BLUE]** operation soft key is pressed, the selection is made or canceled.

(If the **[RED]**, **[GREEN]**, and **[BLUE]** operation soft keys are not displayed, press the rightmost soft key.)

4. Press the **[LIGHT]** or **[DARK]** operation soft key to change the luminance of the selected color element.

● **Storing colors (color palette values)**

A specified color palette value can be stored.

| | | | | | | |
|--|-------|------|--------|--------|--------|---|
| | STORE | CALL | COLOR1 | COLOR2 | COLOR3 | + |
|--|-------|------|--------|--------|--------|---|

1. Select a desired storage area by pressing the **[COLOR1]**, **[COLOR2]**, or **[COLOR3]** operation soft key.

(If the **[COLOR1]**, **[COLOR2]**, and **[COLOR3]** operation soft keys are not displayed, press the rightmost soft key.)

COLOR1 — Standard color data parameters (6561 to 6595)

COLOR2 ┘ Internal RAM

COLOR3 ┘

2. Press the **[STORE]** operation soft key. The following operation soft keys appear.

| | | | | | | |
|--|--|--|--|-----|------|---|
| | | | | CAN | EXEC | + |
|--|--|--|--|-----|------|---|

3. To store the current color palette values in the selected area, press the **[EXEC]** operation soft key. To cancel the storage, press the **[CAN]** operation soft key or the leftmost key.

● **Calling colors (color palette values)**

| | | | | | | |
|--|-------|------|--------|--------|--------|---|
| | STORE | CALL | COLOR1 | COLOR2 | COLOR3 | + |
|--|-------|------|--------|--------|--------|---|

1. Select a color palette storage area by pressing the **[COLOR1]**, **[COLOR2]**, or **[COLOR3]** operation soft key.

(If the **[COLOR1]**, **[COLOR2]**, and **[COLOR3]** operation soft keys are not displayed, press the rightmost soft key.)

2. Press the **[CALL]** operation soft key. The following operation soft keys appear.

| | | | | | | |
|--|--|--|--|-----|------|---|
| | | | | CAN | EXEC | + |
|--|--|--|--|-----|------|---|

3. To call the color palette values from the selected area, press the **[EXEC]** operation soft key. If no color palette value is stored, this step cannot be executed.

To stop calling, press the **[CAN]** operation soft key or the leftmost key.

1.16.3 Parameters

| | #7 | #6 | #5 | #4 | #3 | #2 | #1 | #0 |
|------|-----|----|----|----|----|----|----|----|
| 3119 | NVG | | | | | | | |

[Data type] Bit

NVG When a color display unit is used, the VGA screen display is:

0 : Selected.

1 : Not selected. (Conventional display)

| | |
|------|---|
| 6561 | Standard color data of graphic color 1 |
| 6562 | Standard color data of graphic color 2 |
| 6563 | Standard color data of graphic color 3 |
| 6564 | Standard color data of graphic color 4 |
| 6565 | Standard color data of graphic color 5 |
| 6566 | Standard color data of graphic color 6 |
| 6567 | Standard color data of graphic color 7 |
| 6568 | Standard color data of graphic color 8 |
| 6569 | Standard color data of graphic color 9 |
| 6570 | Standard color data of graphic color 10 |
| 6571 | Standard color data of graphic color 11 |
| 6572 | Standard color data of graphic color 12 |
| 6573 | Standard color data of graphic color 13 |
| 6574 | Standard color data of graphic color 14 |
| 6575 | Standard color data of graphic color 15 |
| 6581 | Standard color data of text color 1 |
| 6582 | Standard color data of text color 2 |
| 6583 | Standard color data of text color 3 |
| 6584 | Standard color data of text color 4 |
| 6585 | Standard color data of text color 5 |
| 6586 | Standard color data of text color 6 |
| 6587 | Standard color data of text color 7 |
| 6588 | Standard color data of text color 8 |
| 6589 | Standard color data of text color 9 |

| | |
|------|--------------------------------------|
| 6590 | Standard color data of text color 10 |
| 6591 | Standard color data of text color 11 |
| 6592 | Standard color data of text color 12 |
| 6593 | Standard color data of text color 13 |
| 6594 | Standard color data of text color 14 |
| 6595 | Standard color data of text color 15 |

[Data type] Two-word

[Unit of data] Six-digit number rrggbb (rr: Red component value, gg: Green component value, bb: Blue component value)

When five digits or less are specified, the missing high-order digits are assumed as zeros.

[Valid data range] Each color component value: 00 to 15 (Equivalent to the color level on the color setting screen)

When 16 or a higher value is specified, 15 is assumed.

(Example) When specifying a color having red component value 1, green component value 2, and blue component value 3, set the parameter value as 10203.

1.16.4 Notes

- (1) At power-up, the color scheme of the screen is determined by the setting in the COLOR1 area (parameters). If no data is stored in the COLOR1 area, the last color scheme before power-down is applied.
- (2) The standard color data specified in parameters must not be changed by direct MDI key input. When changing the parameter data, set and store the new data on the color setting screen.
- (3) When a wrong value is specified in a standard color data parameter, the screen may not be displayed. If this occurs, turn the power on again, while pressing the and keys. This clears the whole stored color scheme and restores the FANUC standard color scheme instead.
Be very careful when performing this operation, as all memory contents such as parameters and programs are lost.
- (4) The VGA-support screen is enabled only for the 8.4-inch color LCD of the Series 0i-C.

1.17 CONTRAST ADJUSTMENT

Depending on the eye level and the viewing angle of the operator, the LCD may be hard to read. This problem can be solved by adjusting the contrast. The contrast of a monochrome LCD can be adjusted.

1. Press the  function key.
2. Press the [SETTING] chapter selection soft key.
The LCD contrast item is displayed on the setting (handy) screen.

```

SETTING (HANDY)
PARAMETER WRITE = 1(0:DISABLE 1: ENABLE)
TV CHECK        = 0(0:OFF 1:ON)
PUNCH CODE      = 0(0:EIA 1:ISO)
INPUT UNIT      = 0(0:MM 1:INCH)
I/O CHANNEL     = 0(0-3:CHANNEL NO.)
SEQUENCE NO.    = 0(0:OFF 1:ON)
TAPE EORMAT     = 0(0:NO CNV 1:F15)
SEQUENCE STOP   = 0(PROGRAM NO.)
SEQUENCE STOP   = 0(SEQUENCE NO.)

[ CONTRAST ] ( + = [ ON:1 ] - = [ OFF:0 ] )
>_
MDI **** * 00:00:00
[NO.SRH] [ ON:1 ] [OFF:0] [+INPUT] [INPUT]

```

3. Move the cursor to "CONTRAST".
4. Adjust the contrast by pressing the operation soft key [ON:1] or [OFF:0].

1.18 POWER MATE CNC MANAGER

When the Power Mate CNC series is used as an additional axis (slave) of the CNC, the Power Mate CNC manager allows the slave data to be displayed and set by the CNC.

The Power Mate CNC manager enables the following display and setting:

- (1) Current position display (absolute/machine coordinates)
- (2) Parameter display and setting
- (3) Diagnosis display
- (4) System configuration screen display
- (5) Alarm display

The Power Mate CNC series that can be used as the slave is a β amplifier with I/O Link.

1.18.1 Parameter

| | | | | | | | | |
|-----|----|-----|-----|-------|-----|-----|-----|-----|
| | #7 | #6 | #5 | #4 | #3 | #2 | #1 | #0 |
| 960 | | 2CH | ASG | SLPWE | PMN | MD2 | MD1 | SLV |

[Data type] Bit

SLV When the Power Mate CNC manager is selected, the screen shows the data of:

0 : A single slave.

1 : Up to four slaves by dividing the screen into four segments.

MD1, MD2 The slave parameters are input from and output to the following devices:

| MD2 | MD1 | I/O device |
|-----|-----|----------------------|
| 0 | 0 | Part program storage |
| 0 | 1 | Memory card |

The parameters are input or output in the program format, no matter which I/O device is selected.

PMN The Power Mate CNC manager function is:

0 : Enabled.

1 : Disabled. (Communication with the slave is not performed.)

SLPWE The settings of slave parameters:

0 : Can be made by Power mate CNC manager regardless of the PWE setting.

1 : Are made according to the PWE setting.

ASG Whether or not the number of bytes allocated to the input/output destination of the β amplifier with I/O links is 16:

0 : Is checked.

1 : Is not checked.

2CH Power mate CNC manager:



0 : Communicates with channel 2.

1 : Communicates with channel 1.

NOTE

- 1 The parameters are valid only when I/O link count extension is supported (two channels are supported).
- 2 Even when 0 is set, Power Mate CNC Manager communicates with channel 1 if the β amplifier with I/O links is not connected to channel 2.
- 3 When 1 is set, Power Mate CNC Manager does not communicate with channel 2 if the β amplifier with I/O links is not connected to channel 1.

1.18.2 Screen Display

1. Press the  function key.
2. Press the continuous menu key  several times. The [PMM] soft key appears.
3. Press the [PMM] soft key. The system configuration screen, which is the initial screen of the Power Mate CNC manager, appears. The screen has the following soft keys (function selection soft keys).

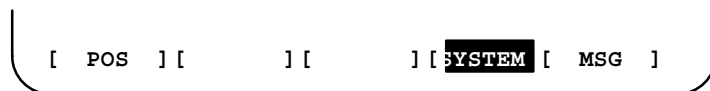



The currently active soft key is displayed in reverse video. Pressing a soft key enables the corresponding function, as indicated below:



POS: Current position display

SYSTEM: System information

MSG: Alarm list

To select another function after one of the functions listed above is selected, press the return menu key  several times until the soft keys are displayed as shown above. Then, select the desired function.

4. To terminate the Power Mate CNC manager, repeatedly press the return menu key  until the function selection keys are displayed as shown above. Then, press the return menu key  once more. The soft keys of the CNC system appear, and the Power Mate CNC manager terminates. The system configuration screen of this function is displayed as the termination screen.

Alternative termination method is to select another function while this function is enabled. To do this, press an MDI function key (, ,

, etc.).

NOTE

After another screen is displayed by pressing a function key, pressing the  function key, restores the initial status of this function. That is, the soft keys shown above are restored. The data that was being input is canceled.

● **System configuration screen**

This screen displays the system software information of the slave. The screen is displayed first when the Power Mate CNC manager function is selected. This screen is automatically displayed also at the termination of the function.

1. Press the [SYSTEM] function selection soft key. The following soft keys are displayed together with the screen displayed when SYSTEM was last selected. The currently active soft key is displayed in reverse video.



2. Press the [SYSTEM] soft key again. The system configuration screen appears. While this screen is displayed, the [SYSTEM] soft key is left displayed in reverse video.

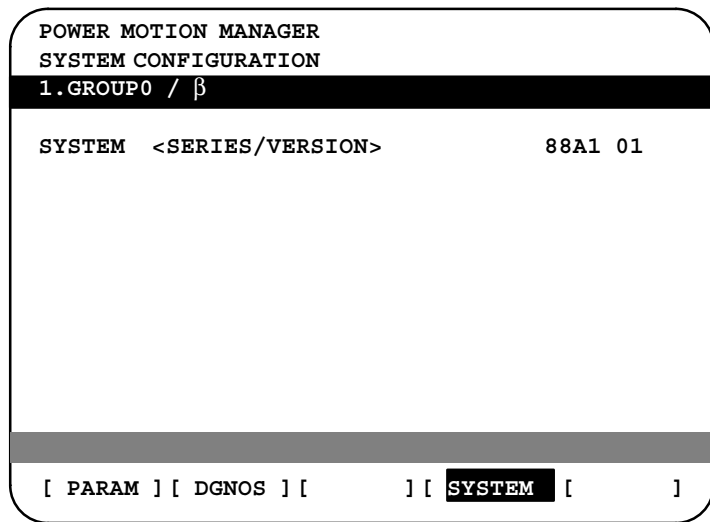

Sample screen: Series and edition of the servo unit β series system list

● **Parameter screen**

The parameters necessary for the functions of the slave must be specified in advance.

1. Press the [SYSTEM] function selection soft key. The following soft keys appear.

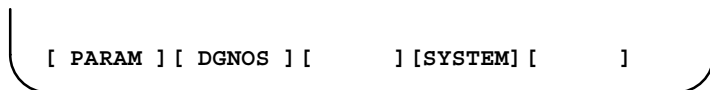

2. Press the [PARAM] soft key. The parameter screen appears.

| POWER MOTION MANAGER | | | |
|----------------------|----------|------|----------|
| PARAMETER | | | |
| 1. GROUP0 / β | | | |
| 0000 | 00001000 | 0010 | 11110000 |
| 0001 | 00010101 | 0011 | 01010000 |
| 0002 | 11111011 | 0012 | 00000000 |
| 0003 | 00000000 | 0013 | 00000000 |
| 0004 | 00000000 | 0014 | 10110001 |
| 0005 | 10100001 | 0015 | 00000000 |
| 0006 | 00000000 | 0016 | 00000000 |
| 0007 | 10000000 | 0017 | 10000010 |
| 0008 | 00000000 | 0018 | 00000000 |
| 0009 | 00000000 | 0019 | 00000000 |

[PARAM] [DGNOS] [] [SYSTEM] []

The screen displays just the bit and decimal data. For details of the parameters, refer to the connection manual of the corresponding Power Mate CNC unit.

- Searching for a parameter

A search can be made for the parameter to be displayed.

1. Select the active slave.
2. Press the [(OPRT)] soft key. The following soft keys appear:

| | | | | |
|------------|-----|-----|-----|-----------|
| [NO.SRH] | [] | [] | [] | [INPUT] |
|------------|-----|-----|-----|-----------|

3. Enter a desired number in the key-in field by using MDI numeric keys. Then, press the [NO.SRH] soft key. The search starts.

- Setting a parameter

A parameter of a slave Power Mate CNC unit can be directly set from the CNC.

1. Select the active slave.
2. Press the [(OPRT)] soft key. The following soft keys appear:

| | | | | |
|------------|-----|-----|-----|-----------|
| [NO.SRH] | [] | [] | [] | [INPUT] |
|------------|-----|-----|-----|-----------|

3. Move the cursor to the parameter to be set.
4. Enter desired data in the key-in buffer by using MDI numeric keys. Then, press the [INPUT] soft key. Alternatively, press the MDI INPUT key.

- **Diagnosis screen**

This screen shows the current status of the slave.

1. Press the [SYSTEM] function selection soft key. The following soft keys appear:

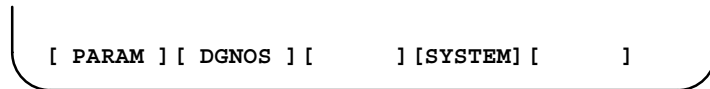

2. Press the [DGNOS] soft key. The diagnosis screen appears. The displayed data is basically the same as the data displayed on the parameter screen.

For details of the diagnosis information, refer to the connection manual of the corresponding Power Mate CNC unit.

- **Current position display**

The screen shows the current position on the workpiece coordinate system or machine coordinate system.

1. Press the [POS] function selection soft key. The following soft keys appear:

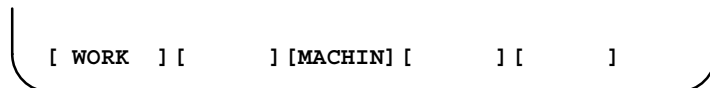

2. To see the absolute coordinate screen, press the [WORK] soft key. To see the machine coordinate screen, press the [MACHIN] soft key.

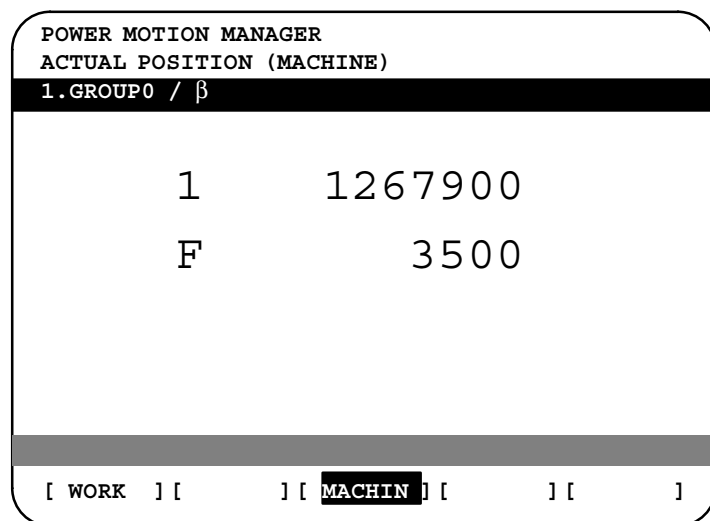

1: Coordinate F: Actual speed

- **Alarm screen**

If an alarm is issued during operation, the group number of the slave causing the alarm is indicated at the right end of the message field on the screen. Check the details on the alarm screen. For example, (13) means that the first and third Power Mate CNC units are in the alarm state.

1. Press the [MSG] function selection soft key. Just the error code is displayed on the screen.

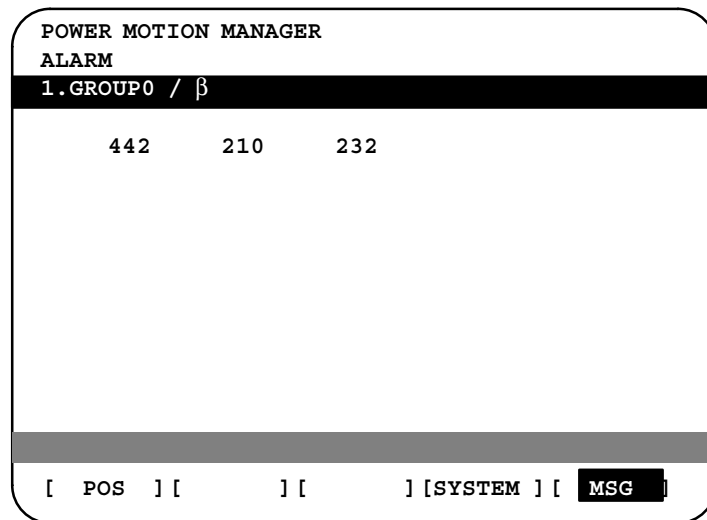

Up to forty codes can be displayed on the screen.

For details of the alarm, refer to the connection manual of the corresponding Power Mate CNC unit.

- **Operating the active slave**

The active slave is subjected to the ZOOM function, which will be described later, and parameter overwrite. The title of the active slave is displayed in a color different from the display color of the other slave titles.

The active slave can be selected by pressing the [↓NEXT] or [↑BACK] soft key, which is displayed after the continuous menu key  is pressed several times.

[↓NEXT]: Displays the screen of the Power Mate CNC unit connected after the currently active slave. The equipment other than the Power Mate CNC unit is ignored.

[↑BACK]: Displays the screen of the Power Mate CNC unit connected before the currently active slave.

- **Single-slave display/
Four-slave display**

Whether the screen displays the data of just a single unit or of four units in four segments is specified in the SLV bit (bit 0 of parameter 960).

To switch the four-slave display to the single-slave display, press the [ZOOM] soft key, which is displayed after the continuous menu key  is pressed several times. The single-slave display shows the data of the active slave. To switch the single-slave display to the four-slave display showing the data of four slaves including the active slave, press the [ZOOM] key.

When five or more slaves are connected, the four-slave display has two or more pages. To see the slave data that is not displayed on the current page, press soft key [↓NEXT].

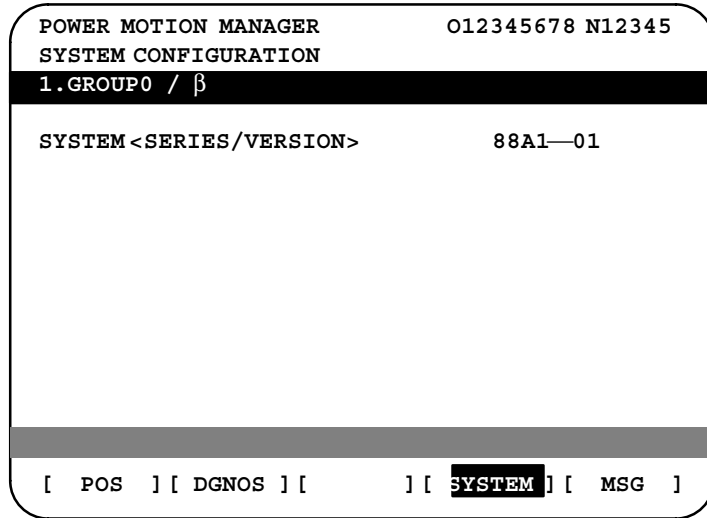

● **Guidance message**

While the following soft keys are being displayed, a guidance message is displayed in the message field.

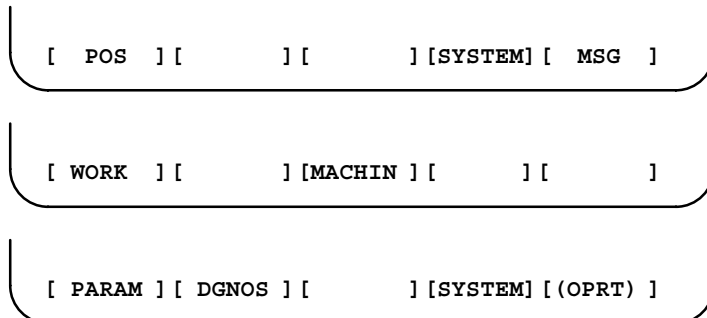

When the soft keys are displayed as shown above, “SELECT ACTIVE SLAVE [>]” is displayed.

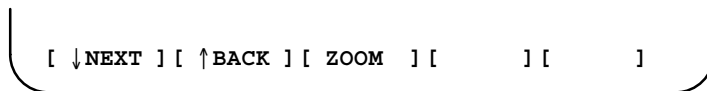

When the soft keys are displayed as shown above, “SELECT ACTIVE SLAVE [↓] [↑]” is displayed.

● **Key-in field**

When the [(OPRT)] soft key is pressed, the message line may turn into a key-in field as required. The numeric data input by using MDI keys is displayed after the prompt (>).

On the parameter and diagnosis screens, the key-in field appears when just a numeric value is input. The soft key [(OPRT)] need not be pressed.

1.18.3 Parameter Input/Output

• Saving parameters

Parameters can be saved in CNC memory or a memory card as a data file of program format. Specify the first digit of the registration program number in parameter No. 8760. Programs with predetermined numbers are created for individual slaves. When the parameters are saved in CNC memory, a program having the specified program number is created. When the parameters are saved in a memory card, a file is created, to which the file name consists of the specified program number and an extension PMM.

Example: When parameter No. 8760 is set to 8000

The program number for group n is $8000 + n \cdot 10$.

The group number n is indicated in the title area of each slave.

CAUTION

In case that the parameters are saved in a memory card, if the specified program number already exists on memory card, the corresponding program is overwritten with new data.

Specify a desired input device in the MD1 and MD2 bits (bits 1 and 2 of parameter 960). Connect a memory card. Alternatively, check the free area of CNC memory. Then, follow the steps given below:

1. Select the active slave.
2. Press the [(OPRT)] soft key. The following soft keys appear:

[NO.SRH] [] [] [] [INPUT]

3. Press the continuous menu key . The following soft keys appear:

[] [READ] [PUNCH] [] []

4. Press the [READ] soft key. The following soft keys appear:

[] [] [] [CANCEL] [EXEC]

5. Press the [EXEC] soft key.

During input, "INPUT" blinks in the message field.

- **Writing parameters**

The data file of parameters saved in CNC memory or a memory card as a program is written into the slave determined by the program number. The program number and memory device are determined as described in “Saving parameters.”

1. Select the active slave.
2. Press the [(OPRT)] soft key. The following soft keys appear:

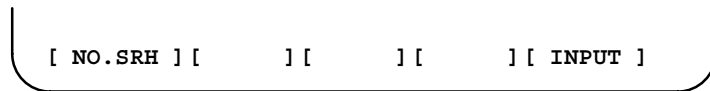

[NO.SRH] [] [] [] [INPUT]

3. Press the next-menu key. The following soft keys appear:



[] [READ] [PUNCH] [] []

4. Press the [PUNCH] soft key. The following soft keys appear:

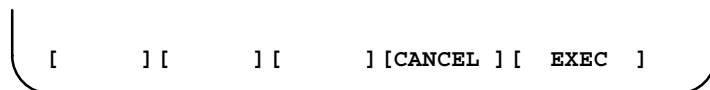

[] [] [] [CANCEL] [EXEC]

5. Press the [EXEC] soft key.

During output, “INPUT” blinks in the message field.

The screen cannot be changed to another screen during parameter input/output.

When the RESET key is pressed, or when an alarm status is detected in communication, the input/output stops.

1.18.4

Notes

- **Connecting an I/O Link**

When the Power Mate CNC series is used as a slave of an I/O Link, the CNC assigns I/O addresses. The salve data is input and output in units of 16 bytes. Therefore, 128 input/output points are necessary. Up to eight slaves can be connected.

The module name is OC021 (16-byte input) or OC020 (16-byte output). BASE is always 0, and SLOT is always 1.

- **Ignoring the Power Mate CNC manager function**

After the data necessary for each slave connected is set and checked, the communication of the Power Mate CNC manager (PMM) can be stopped to send a command from the CNC ladder to the slave.

When the PMN bit (bit 3 of parameter 960) is set to 1, all communication between CNC and the slave via the I/O Link is open to the ladder.

While the bit is held 1, the screen shows just the title, function name, and other items that are independent of the communication. The following message appears to indicate that communication has stopped.

COMMUNICATION PROHIBITED BY P960#3

- **Data input/output by I/O Link**

When the Power Mate CNC manager is used, the function for data input/output by I/O Link cannot be used.

- **Alarm**

(1) CNC

When a CNC alarm status is detected, the screen is automatically switched to the CNC alarm screen. Check the details of the alarm. If necessary, display and select the Power Mate CNC manager screen again by pressing function key  .

(2) Slave

A guidance message is usually displayed in the message field. If a slave alarm is detected, the corresponding slave group number is displayed at the right end.

Display the alarm screen to check the details.

- **Data protection key**

When the data protection key of the CNC is turned on, parameters cannot be input to CNC memory.

1.19 PERIODIC MAINTENANCE SCREENS

Using the periodic maintenance screens makes it easy to manage consumables (such as LCD unit backlight and backup battery) that are to be replaced periodically.

Setting the name and service life of consumables, and the countdown method to be used for them enables counting of the remaining service time according to the specified countdown method and displaying of the result.

1.19.1 Overview

- **Screen configuration**

The following periodic maintenance screens are available:



- (1) Status screen: Displays item names, remaining service time, countdown status, and lets you specify item names.
- (2) Setting screen: Lets you specify service life, remaining service time, and count type (countdown method).
- (3) Machine system menu screen: Enables registering the names of consumables used in the machine.
- (4) NC system menu screen: Displays the names of registered consumables used in the NC.

- **Procedure**

To use this function, follow the steps below:

- (1) Select a number for registration (using the cursor key on the status screen).
- (2) Specify an item name.
The following two methods are available.
 - Selecting a name from a menu screen (machine or NC system menu screen).
 - Entering a name to the status screen directly from the MDI.
 Using the machine system menu screen requires that item names be registered previously.
- (3) Specify the service life, remaining service time, and count type for a target item.
Once they are specified, the remaining service time can be checked on the status screen.

1.19.2 Screen Display and Setting

- 1 Press the  function key.
- 2 Press the  continuous menu key several times. Soft key [MAINTE] appears.
- 3 Press soft key [MAINTE]. A periodic maintenance screen appears.

There are two periodic maintenance screens, status and setting screens. Either screen can be selected using soft key [CHANGE].

1.19.3 Status Screen Display and Setting

Up to 10 consumable items can be registered for management. Their remaining service time and count status are displayed on the status screen.

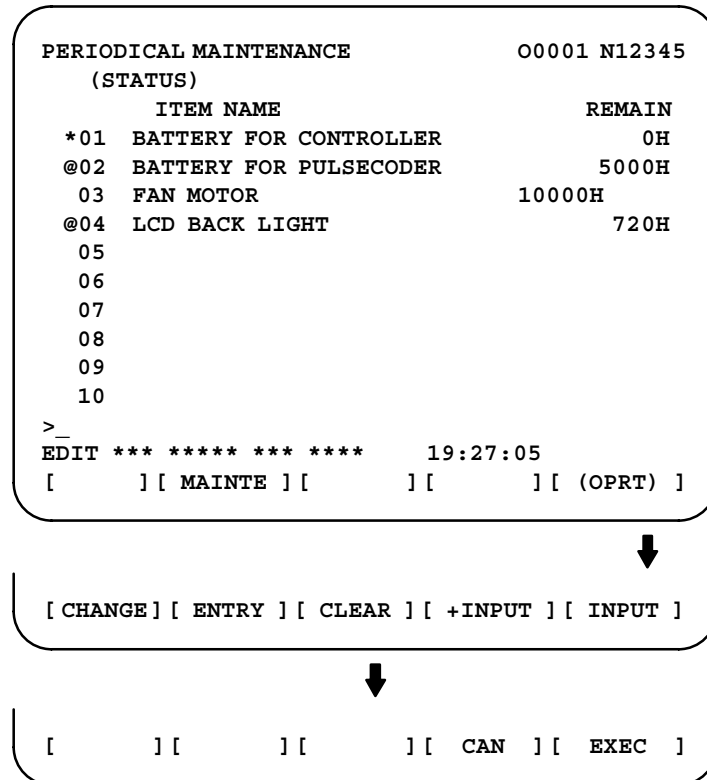

(1) Item name

The name of an item to be subjected to periodic maintenance is specified under “Item name.”

Two methods can be used to specify item names. The first method uses the menu screen, and the second, the MDI keypad.

(1) Method of using the menu screen

- 1 Place the cursor on the target item name, and press soft key [ENTRY]. A menu screen appears. The menu screen is either the machine or NC system menu screen.
- 2 Press soft key [MACHIN] or [NC]. A machine system menu appears. It holds the names of consumables typical to the machine system or NC system.
- 3 Place the cursor on a registered item name, and press soft key [SELECT], then soft key [EXEC]. The status screen appears again, enabling the selected item to be set up.
- 4 Press soft key [CAN]. The previous soft key displays appear again.
- 5 Press soft key [MAINTE]. The status screen appears again.

Using the machine system menu screen requires that item names be registered on the screen previously.

This can be done using two methods, (a) and (b).

(a) Program-based registration

Executing a program in the following format enables item names to be registered on the machine system menu screen.

Format

G10 L61 Px [n]

x... Registration number
 n... Item name
 [Alphanumeric characters*two-byte
 characters*alphanumeric characters]

(b) MDI keypad-based registration

An item name can be registered on the machine system menu screen by first entering it in the following format, then pressing soft key [INPUT] (or function key).

Pressing soft key [+INPUT] adds the item name to the list of previously registered item names.

Format

Alphanumeric characters*two-byte characters*alphanumeric characters

The two-byte characters shall comply with the FANUC code. (See Section 1.19.6.)

When entering a two-byte character, sandwich it with an “*” pair.

The item name can consist of up to 24 alphanumeric characters (if no two-byte character is included) or 12 two-byte characters (if no alphanumeric character is included).

Example) To register “LCD backlight,” enter:
 >LCD*110E10F410CC114010B610FE_

NOTE

- 1 “*” cannot be used in item names, because it is used as control code. “[”, “]”, “(”, or “)” also cannot be used in item names.
- 2 When both alphanumeric and two-byte characters are used in an item name to be registered, the warning message “DATA IS OUT OF RANGE” may appear even if the maximum allowable number of characters has not been exceeded.
- 3 If a blank item name is selected from the machine system screen, the warning message “EDIT REJECTED” appears. If a blank item name is selected from the NC system screen, a blank is set up.

To erase the registered data for an item, place the cursor on the target item name, and press soft key [CLEAR], then soft key [EXEC].

[Machine system] menu screen

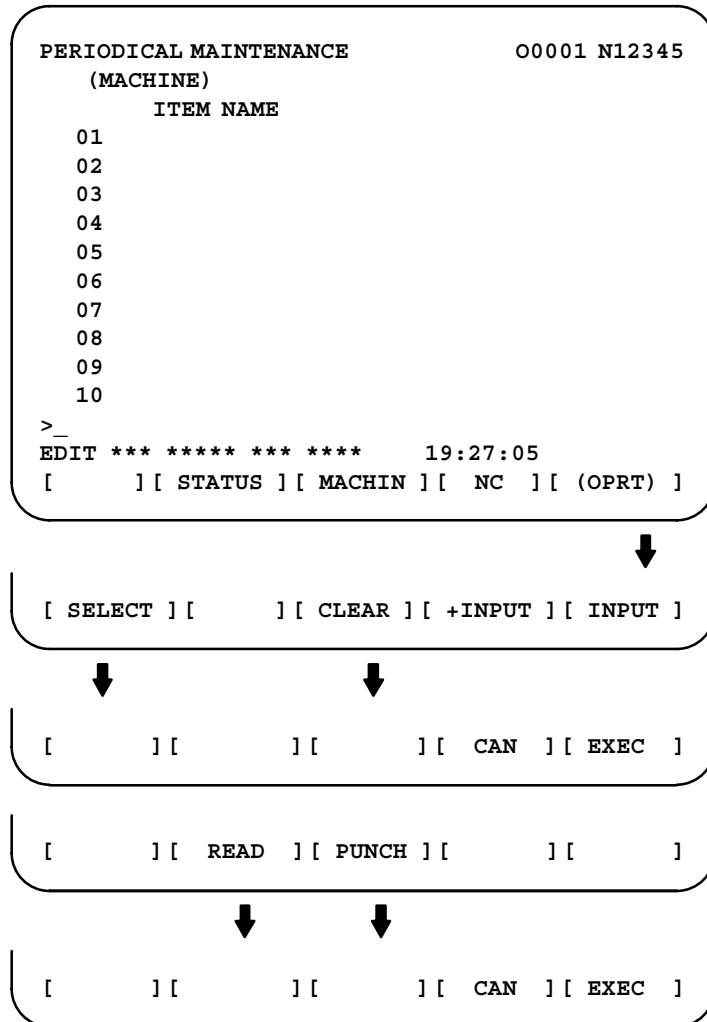

[NC system] menu screen

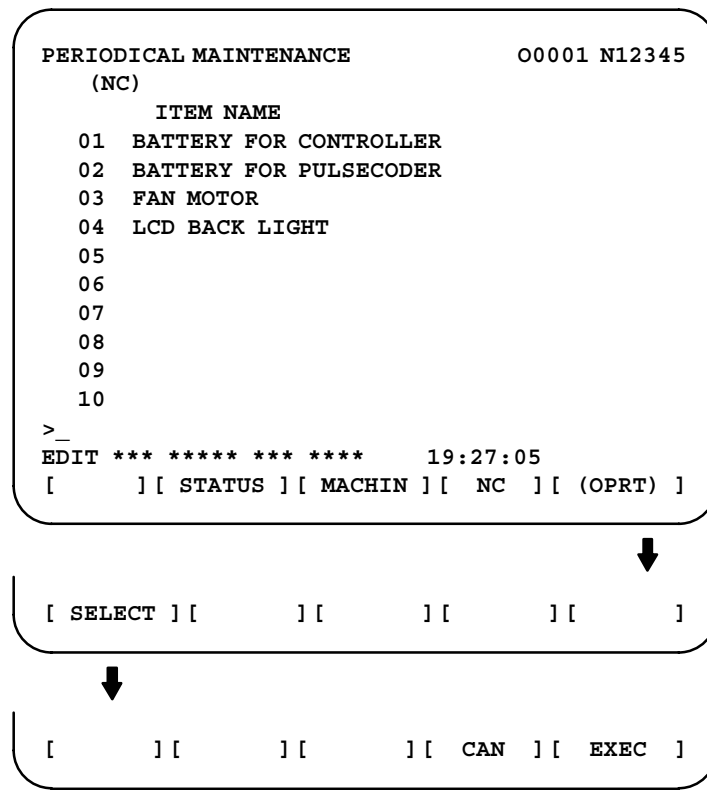

NOTE

On the NC system screen, no item name can be registered, erased, input, or output.

(2) MDI keypad-based setting

An item name can be registered on the status screen by first entering it in the following format using keys, then pressing soft key [INPUT] (or the key).

Pressing soft key [+INPUT] adds the item name to the list of previously registered item names.

Format

Alphanumeric characters*two-byte characters*alphanumeric characters

The two-byte characters shall comply with the FANUC code. (See Section 1.19.6.)

When entering a two-byte character using keys, sandwich it with an “*” pair.

The item name can consist of up to 24 alphanumeric characters (if no two-byte character is included) or 12 two-byte characters (if no alphanumeric character is included).

Example) To register “LCD backlight,” enter:

```
>LCD*110E10F410CC114010B610FE_
```

NOTE

- 1 "*" cannot be used in item names, because it is used as control code. "[", "]", "(", or ")" also cannot be used in item names.
- 2 When both alphanumeric and two-byte characters are used in an item name to be registered, the warning message "DATA IS OUT OF RANGE" may appear even if the maximum allowable number of characters has not been exceeded.

To erase the registered data for an item, place the cursor on the target item name, press soft key [CLEAR], then [EXEC].

When an item name is deleted, the related service life, remaining service time, and count type are also deleted.

(2) Remaining service time

The remaining service time of an item (the time allowed before the item is replaced) is obtained by count-down and displayed under "Remaining service time." When the remaining service time decreases to a specified percentage (specified in parameter No. 8911) of the service life or lower, it is displayed in red.

Count-down continues even after the service life has expired.

NOTE

Setting is impossible on the status screen.
It should be done on the setting screen.

(3) Count status

The count status is displayed at the left of the corresponding item number, as listed below:

| Display | Count status |
|---------|-------------------------------|
| Blank | Count suspended |
| @ | Count under way |
| * | The service life has expired. |

1.19.4 Setting Screen Display and Setting

The setting screen lets you specify the service life, the remaining service time, and count type for a registered item name. It also displays the same count status information as displayed on the status screen.

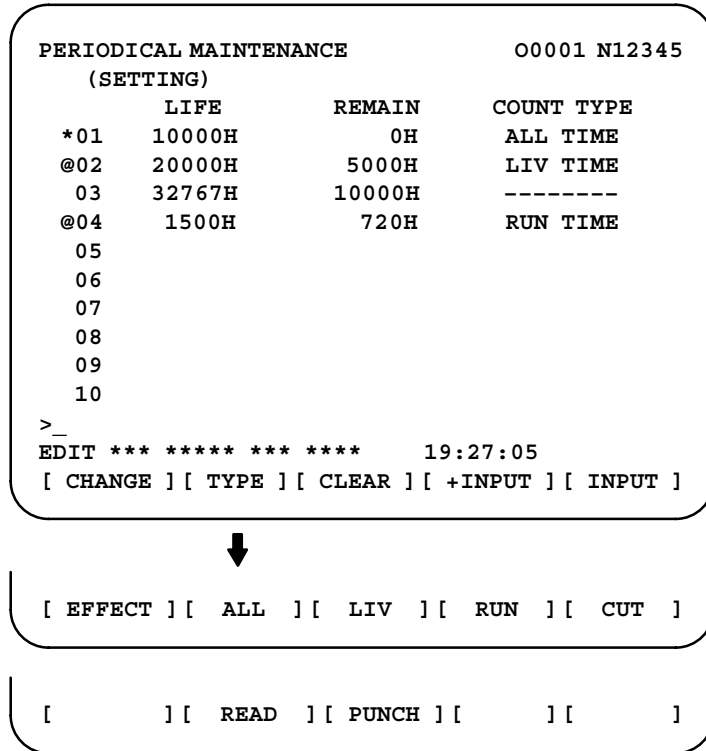

(1) Service life

The service life of a consumable item is to be specified under “Service life.”

First place the cursor on the service life of a target registration number, enter a desired service life value using numeric keys, then press soft key [INPUT] (or the key). The specified service life is set up,

and the same value is set up also under “Remaining service time.”

In addition, the count type for the item changes to: “_____”

Pressing soft key [+INPUT] adds the newly specified service life value to the previously specified life value. The added service life value is reflected to the remaining service time.

The valid data range for the service life is: 0 to 65535 (hours)

NOTE

- 1 An attempt to set up the service life for a non-registered item results in the warning message “EDIT REJECTED”.
- 2 An attempt to enter a value that is out of the valid data range results in the warning message “DATA IS OUT OF RANGE”.
- 3 An attempt to enter a value that would make the service life or remaining service time 0 or lower, it is clamped at 0.
- 4 Pressing soft keys [CLEAR] and [TYPE] results in the warning message “EDIT REJECTED”.

(2) Remaining service time

The remaining service time of an item (the time allowed before the item is replaced) is determined by count-down and displayed under “Remaining service time.” When the remaining service time decreases to a specified percentage (specified in parameter No. 8911) of the service life or lower, it is displayed in red.

Count-down continues even after the service life has expired.

First place the cursor on the remaining service time of a target registration number, enter a desired remaining service time value using numeric keys, then press soft key [INPUT] (or the key).

Pressing soft key [+INPUT] adds the newly specified remaining service time to the previously specified remaining service time.

The valid data range for the remaining service time is: 0 to (service life)

After soft key [CLEAR] is pressed, pressing soft key [EXEC] sets the remaining service time with the same value as for the service life.

NOTE

- 1 An attempt to set up the remaining service time for a non-registered item or an item for which the service life has not been set up results in the warning message “EDIT REJECTED”.
- 2 An attempt to enter a value that is out of the valid data range results in the warning message “DATA IS OUT OF RANGE”.
- 3 An attempt to enter a value that would make the remaining service time 0 or lower, it is clamped at 0.
4. Pressing soft key [TYPE] results in the warning message “EDIT REJECTED”.

(3) Count type

The type of a selected count method is specified under “Count type.”

After the cursor is placed on the count type of a target registration number, pressing soft key [TYPE] displays the next count type as a soft key. Select it and press soft key [EXEC].

| Soft key | Meaning | Display |
|----------|-------------------------------------|---------------|
| [NO CNT] | Not counting (suspended). | — |
| [ALL] | Always count. | All times |
| [PWR ON] | Count while the power is supplied. | Power-on time |
| [RUN] | Count while operation is under way. | Operating |
| [CUT] | Count while cutting is under way. | Cutting |

NOTE

- 1 An attempt to set up the count type for a non-registered item or an item for which the service life has not been set up results in the warning message "EDIT REJECTED".
- 2 Soft keys [INPUT] and [+INPUT] are ignored.
- 3 In leap years, an error of 24 hours occurs in the all-time count.
- 4 Pressing soft key [CLEAR] results in the warning message "EDIT REJECTED".

**1.19.5
Registered Data
Input/Output**

Pressing soft key [PUNCH] enables registered data to be output to an external unit.

Pressing soft key [READ] enables data to be input from an external unit. These operations can be done on the status, setting, and machine system menu screens.

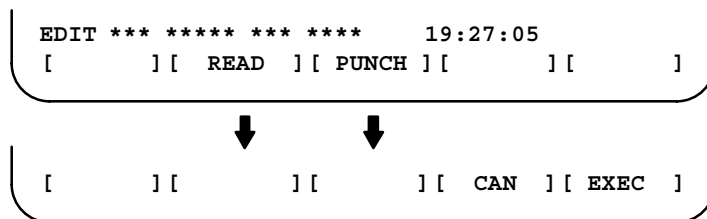

• **Data output**

After the EDIT mode is selected, pressing soft key [PUNCH] outputs the registered data in the following format.

Format

Format for output from the status and setting screens

```

G10 L60 P01 Aa Rr [n] Qq ;
G10 L60 P02 Aa Rr [n] Qq ;
G10 L60 P03 Aa Rr [n] Qq ;
:
    
```

Format

Format for output from the machine system menu

```

G10 L61 P01 [n] ;
G10 L61 P02 [n] ;
G10 L61 P03 [n] ;
:
    
```

- a : Service life
- r : Remaining service time
- n : Item name
[Alphanumeric characters*two-byte characters * alphanumeric characters]
- q : count type
 - 0 = not to count
 - 1 = count at all times
 - 2 = count during power-on time
 - 3 = count during operation
 - 4 = count during cutting

● Data input

After the EDIT mode is selected, pressing soft key [READ] causes data to be registered with item names according to the format in which the data is input (G10).

Data registration can be done even by executing the format (G10) once input to the program memory.

This requires a programmable data input option.

NOTE

If the input format (G10) differs from the output format, registration may fail.

Parameter

8911

Percentage to the service life of each item displayed on the periodic maintenancescreen

[Data type] Byte

[Unit of data] 1%

[Valid data range] 0 to 100

On the periodic maintenance screens, any remaining service time value smaller than the specified percentage to the service life is displayed in red for warning purposes.

1.19.6

FANUC Two-Byte
Character Code Table

| | 00 | 02 | 04 | 06 | 08 | 0A | 0C | 0E | 10 | 12 | 14 | 16 | 18 | 1A | 1C | 1E |
|------|----|----|----|----|----|----|----|----|----|----|----|----|----|----|----|----|
| 0200 | あ | あ | い | い | う | う | え | え | お | お | か | が | き | ぎ | く | ぐ |
| 0220 | け | げ | こ | ご | さ | ざ | し | じ | す | ず | せ | げ | そ | ぞ | た | だ |
| 0240 | ち | ぢ | っ | っ | づ | づ | で | と | ど | な | に | ぬ | ね | の | は | ば |
| 0260 | ぱ | ひ | び | び | ふ | ぶ | ぶ | へ | べ | な | ほ | ぼ | ぼ | ま | み | む |
| 0280 | め | も | ゃ | ゃ | ゆ | ゆ | よ | よ | り | な | る | れ | ろ | わ | わ | む |
| 02A0 | 材 | を | ん | 種 | 類 | 棒 | 穴 | 成 | 形 | 質 | 寸 | 法 | 外 | 長 | 素 | 端 |
| 02C0 | 面 | 最 | 小 | 内 | 大 | 加 | 工 | 切 | 削 | 倣 | 正 | 途 | 中 | 具 | 番 | 軸 |
| 02E0 | 号 | 仕 | 上 | 込 | 点 | 方 | 向 | 速 | 度 | 送 | 量 | 開 | 始 | 主 | 軸 | 軸 |
| 0300 | 回 | 転 | 数 | 位 | 置 | 決 | 直 | 線 | 時 | 円 | 反 | 現 | 在 | 指 | 令 | 値 |
| 0320 | 領 | 域 | 診 | 断 | 操 | 作 | 手 | 引 | 機 | 械 | 残 | 移 | 動 | 次 | 早 | 電 |
| 0340 | 源 | 投 | 入 | 間 | 分 | 秒 | 自 | 運 | 負 | 荷 | 実 | 使 | 用 | 寿 | 命 | 新 |
| 0360 | 規 | 除 | 隅 | 取 | 单 | 補 | 能 | 独 | 終 | 了 | 記 | 角 | 溝 | 刃 | 幅 | 広 |
| 0380 | 設 | 定 | 一 | 覧 | 表 | 部 | 炭 | 合 | 金 | 鋼 | 超 | 硬 | 先 | 付 | 摩 | 耗 |
| 03A0 | 仮 | 想 | 副 | 行 | 挿 | 消 | 去 | 山 | 高 | 準 | 備 | 完 | 後 | 弧 | 助 | 未 |
| 03C0 | 無 | 視 | 器 | 原 | 登 | 録 | 再 | 処 | 理 | 推 | 画 | 過 | 容 | 編 | 集 | 閉 |
| 03E0 | 対 | 相 | 座 | 標 | 示 | 名 | 齒 | 変 | 呼 | 馬 | 力 | 力 | 系 | 選 | 達 | |

| | 00 | 02 | 04 | 06 | 08 | 0A | 0C | 0E | 10 | 12 | 14 | 16 | 18 | 1A | 1C | 1E |
|------|----|----|----|----|----|----|----|----|----|----|----|----|----|----|----|----|
| 0400 | 禁 | 復 | 婦 | 書 | 個 | 桁 | 稼 | 由 | 兩 | 半 | 逃 | 底 | 逆 | 下 | 空 | 四 |
| 0420 | 觸 | 平 | 代 | 邊 | 格 | 子 | 周 | 心 | 本 | 群 | 停 | 止 | 巾 | 微 | 狀 | 路 |
| 0440 | 範 | 因 | 倍 | 率 | 注 | 側 | 特 | 殊 | 距 | 離 | 連 | 統 | 增 | 隔 | 件 | 初 |
| 0460 | 期 | 條 | 經 | 握 | 压 | 扱 | 陰 | 隱 | 右 | 押 | 橫 | 黃 | 億 | 屋 | 化 | 何 |
| 0480 | 繪 | 階 | 概 | 該 | 卷 | 換 | 氣 | 起 | 軌 | 技 | 疑 | 供 | 共 | 境 | 強 | 教 |
| 04A0 | 掘 | 線 | 係 | 傾 | 型 | 檢 | 權 | 研 | 肩 | 見 | 驗 | 元 | 弦 | 滅 | 孔 | 巧 |
| 04C0 | 控 | 更 | 校 | 構 | 根 | 左 | 差 | 雜 | 參 | 散 | 產 | 算 | 治 | 耳 | 式 | 失 |
| 04E0 | 修 | 十 | 從 | 勝 | 商 | 少 | 尚 | 昇 | 植 | 色 | 食 | 伸 | 信 | 振 | 浸 | |
| 0500 | 真 | 暗 | 以 | 意 | 異 | 影 | 銳 | 越 | 倆 | 可 | 科 | 果 | 箇 | 課 | 各 | 抃 |
| 0520 | 核 | 學 | 掛 | 漢 | 簡 | 觀 | 閔 | 含 | 却 | 客 | 休 | 急 | 業 | 曲 | 均 | 筋 |
| 0540 | 繼 | 計 | 輕 | 言 | 限 | 互 | 降 | 採 | 濟 | 細 | 姿 | 思 | 寫 | 射 | 斜 | 者 |
| 0560 | 車 | 借 | 縱 | 重 | 出 | 述 | 術 | 涉 | 照 | 省 | 章 | 証 | 象 | 身 | 進 | 人 |
| 0580 | 凶 | 違 | 印 | 沿 | 遠 | 央 | 奧 | 往 | 底 | 会 | 解 | 改 | 割 | 活 | 願 | 基 |
| 05A0 | 奇 | 寄 | 岐 | 既 | 近 | 区 | 矩 | 驅 | 偶 | 旧 | 求 | 球 | 究 | 級 | 欠 | 結 |
| 05C0 | 口 | 語 | 誤 | 交 | 厚 | 項 | 刻 | 告 | 黑 | 財 | 策 | 系 | 試 | 資 | 事 | 持 |
| 05E0 | 似 | 積 | 弱 | 受 | 収 | 純 | 順 | 所 | 序 | 剩 | 場 | 常 | 飾 | 水 | 錐 | 据 |
| 0600 | 制 | 整 | 製 | 前 | 全 | 然 | 則 | 屬 | 即 | 他 | 多 | 存 | 谷 | 探 | 短 | 徵 |
| 0620 | 鎖 | 調 | 頂 | 鉄 | 添 | 頭 | 同 | 導 | 道 | 熱 | 年 | 濃 | 箱 | 究 | 拔 | 伴 |
| 0640 | 必 | 百 | 複 | 物 | 文 | 間 | 併 | 忘 | 末 | 密 | 有 | 余 | 与 | 裏 | 立 | 略 |
| 0660 | 青 | 席 | 石 | 積 | 赤 | 接 | 折 | 粗 | 創 | 双 | 搜 | 太 | 打 | 体 | 待 | 態 |
| 0680 | 替 | 段 | 知 | 地 | 致 | 遲 | 追 | 通 | 佗 | 得 | 誑 | 凸 | 凹 | 突 | 鈍 | 敗 |
| 06A0 | 杯 | 背 | 配 | 品 | 不 | 布 | 並 | 頁 | 別 | 片 | 返 | 勉 | 弁 | 保 | 明 | 滅 |
| 06C0 | 木 | 目 | 歪 | 搖 | 樣 | 溶 | 要 | 抑 | 良 | 輪 | 和 | 話 | 梓 | 節 | 說 | 絕 |
| 06E0 | 千 | 專 | 淺 | 旋 | 總 | 走 | 退 | 台 | 第 | 題 | 卓 | 室 | 着 | 柱 | 鑄 | 丁 |
| 0700 | 低 | 訂 | 肉 | 日 | 白 | 薄 | 比 | 皮 | 被 | 非 | 美 | 普 | 伏 | 步 | 包 | 門 |
| 0720 | 問 | 絡 | 列 | 万 | 利 | 訊 | 礼 | 乱 | 放 | 枚 | 約 | 練 | 油 | 劣 | 例 | 郭 |
| 0740 | 戾 | 冷 | 垂 | 綠 | 紫 | 許 | 測 | 精 | 効 | → | ↗ | ↑ | ↘ | ← | ↙ | ↓ |
| 0760 | ↘ | Q | ○ | ∩ | ○ | ■ | 板 | 予 | 〃 | 家 | 裝 | 管 | 粉 | 等 | ▽ | ▽ |
| 0780 | ∞ | ∞ | ∞ | 安 | α | β | 程 | 抗 | 張 | 任 | 破 | 損 | 御 | 足 | 守 | 般 |
| 07A0 | 納 | 義 | 貫 | 汎 | 固 | 每 | 当 | 的 | 詳 | 鳥 | 適 | 論 | 額 | 緣 | 温 | 給 |
| 07C0 | 界 | 混 | 丸 | 締 | 護 | 己 | 称 | 樹 | 脂 | 料 | 落 | 確 | 認 | 報 | 排 | 性 |
| 07E0 | 生 | 績 | 監 | 搬 | 砥 | θ | 島 | 壁 | ◇ | ◇ | ◇ | ◇ | □ | 〃 | 〃 | ■ |

| | 00 | 02 | 04 | 06 | 08 | 0A | 0C | 0E | 10 | 12 | 14 | 16 | 18 | 1A | 1C | 1E |
|------|----------|----------|----------|----------|----------|----------|----------|----------|----------|----------|----------|----------|----------|----------|----------|----------|
| 0800 | 阿慰院衛憶菓効乾 | 哀易羽液臆貨害寒 | 愛為雨益牡我慨刊 | 挨維渦馱乙牙街勸 | 逢緯唄園恩芽垣喚 | 惡胃浦延穩賀殼官 | 旭衣瓜援音雅獲寬 | 宛遺樽演佳介覺干 | 案医雲炎夏壞較幹 | 闇井營煙暇廻革感 | 鞍育映鉛架快樂慣 | 伊一榮塩歌怪笠敢 | 依稻永汚河海括歡 | 偉員泳王火灰滑汗 | 委因洩岡花皆株環 | 威飲英冲華貝刈甘 |
| 0820 | | | | | | | | | | | | | | | | |
| 0840 | | | | | | | | | | | | | | | | |
| 0860 | | | | | | | | | | | | | | | | |
| 0880 | | | | | | | | | | | | | | | | |
| 08A0 | | | | | | | | | | | | | | | | |
| 08C0 | | | | | | | | | | | | | | | | |
| 08E0 | | | | | | | | | | | | | | | | |
| 0900 | 看喜議拳鏡屈劇犬 | 緩希菊虛響熊激猷 | 缶幾詰魚驚君隙絹 | 肝揮脚亨凝訓潔具 | 還机丘享局軍血謙 | 鑑旗久京極郡月軒 | 閑棄及競玉刑儉鍵 | 陷毅吸協勤兄健險 | 韓祈宮叫錦契兼幻 | 館季弓挾琴揭券古 | 岸稀救橋銀敬劍庫 | 眼徽泣況九景圈戶 | 岩輝牛狹句莖堅故 | 顏騎居胸苦警建湖 | 企擬巨興馳芸憲狐 | 危犧拒鄉屑迎拳誇 |
| 0920 | | | | | | | | | | | | | | | | |
| 0940 | | | | | | | | | | | | | | | | |
| 0960 | | | | | | | | | | | | | | | | |
| 0980 | | | | | | | | | | | | | | | | |
| 09A0 | | | | | | | | | | | | | | | | |
| 09C0 | | | | | | | | | | | | | | | | |
| 09E0 | | | | | | | | | | | | | | | | |
| 0A00 | 顧江国災冊士湿舟 | 五港穀碎刷姊芝週 | 午甲酷祭察市綺住 | 侯稿腰菜撮師捨柔 | 候絞骨裁擦支煮宿 | 光綱此載札枝社祝 | 公考頃際殺死謝縮 | 勾肯今劑皿私尺熟 | 喉衡困罪三紙若春 | 好講婚坂撒詞酒瞬 | 孝購查阪讚詩首盾 | 幸郊砂咲贊字授巡 | 康鉞債昨酸寺需暑 | 弘香妻索伺磁秋女 | 拘剛彩錯刺辭習傷 | 攻克才桜史七臭唱 |
| 0A20 | | | | | | | | | | | | | | | | |
| 0A40 | | | | | | | | | | | | | | | | |
| 0A60 | | | | | | | | | | | | | | | | |
| 0A80 | | | | | | | | | | | | | | | | |
| 0AA0 | | | | | | | | | | | | | | | | |
| 0AC0 | | | | | | | | | | | | | | | | |
| 0AE0 | | | | | | | | | | | | | | | | |
| 0B00 | 獎淨陣清占訴東隊 | 將蒸須盛宣倉俗淹 | 床錠酢聖尖層卒宅 | 承職吹声川掃其拓 | 招唇粹西戰巢揃濯 | 昭寢遂誓扇争尊託 | 燒審杉請栓窓村濁 | 焦森裾静泉草詫奪 | 笑申澄稅洗騷墮脫 | 紹神世昔染像妥棚 | 衝芯是析潛臟耐誰 | 賞親勢籍船蔵帶嘆 | 障辛征責銑贈怠担 | 乘針政跡鮮造滯淡 | 城震星雪善促袋团 | 情尽晴舌組息貸彈 |
| 0B20 | | | | | | | | | | | | | | | | |
| 0B40 | | | | | | | | | | | | | | | | |
| 0B60 | | | | | | | | | | | | | | | | |
| 0B80 | | | | | | | | | | | | | | | | |
| 0BA0 | | | | | | | | | | | | | | | | |
| 0BC0 | | | | | | | | | | | | | | | | |
| 0BE0 | | | | | | | | | | | | | | | | |

| | 00 | 02 | 04 | 06 | 08 | 0A | 0C | 0E | 10 | 12 | 14 | 16 | 18 | 1A | 1C | 1E |
|------|----|-----|-----|-----|-----|-----|-----|-----|------|------|----|----|----|----|----|----|
| 0C00 | 暖 | 男 | 談 | 池 | 築 | 畜 | 竹 | 筑 | 秩 | 茶 | 昼 | 虫 | 駐 | 貯 | 帳 | 庁 |
| 0C20 | 彫 | 挑 | 朝 | 町 | 脹 | 腸 | 跳 | 沈 | 珍 | 賃 | 墜 | 痛 | 塚 | 爪 | 吊 | 釣 |
| 0C40 | 庭 | 廷 | 提 | 釘 | 泥 | 摘 | 滴 | 笛 | 典 | 天 | 展 | 店 | 貼 | 殿 | 田 | 吐 |
| 0C60 | 塗 | 徒 | 都 | 砥 | 努 | 土 | 怒 | 倒 | 冬 | 凍 | 刀 | 島 | 東 | 湯 | 灯 | 答 |
| 0C80 | 筒 | 統 | 到 | 藤 | 討 | 踏 | 透 | 働 | 堂 | 胴 | 銅 | 峠 | 毒 | 届 | 届 | 曇 |
| 0CA0 | 謎 | 鍋 | 繩 | 南 | 軟 | 難 | 二 | 勺 | 乳 | 尿 | 念 | 燃 | 恼 | 腦 | 農 | 八 |
| 0CC0 | 把 | 波 | 派 | 廐 | 拜 | 肺 | 買 | 壳 | 博 | 拍 | 泊 | 舶 | 肌 | 畑 | 秘 | 肥 |
| 0CE0 | 罰 | 版 | 犯 | 班 | 繁 | 販 | 飯 | 盤 | 否 | 彼 | 悲 | 扉 | 疲 | 秘 | 秘 | 肥 |
| 0D00 | 費 | 避 | 飛 | 尾 | 鼻 | 菱 | 筆 | 俵 | 水 | 票 | 評 | 病 | 浜 | 貧 | 敏 | 夫 |
| 0D20 | 婦 | 富 | 怖 | 浮 | 父 | 符 | 腐 | 武 | 舞 | 封 | 風 | 服 | 福 | 腹 | 弘 | 沸 |
| 0D40 | 噴 | 憤 | 奮 | 紛 | 丙 | 兵 | 幣 | 柄 | 米 | 壁 | 癖 | 偏 | 便 | 捕 | 募 | 墓 |
| 0D60 | 母 | 簿 | 寶 | 崩 | 捧 | 泡 | 胞 | 芳 | 訪 | 豐 | 飽 | 亡 | 傍 | 剖 | 妨 | 帽 |
| 0D80 | 忙 | 房 | 暴 | 望 | 紡 | 肪 | 膨 | 防 | 北 | 撲 | 撲 | 釘 | 沒 | 翻 | 磨 | 魔 |
| 0DA0 | 幕 | 膜 | 迄 | 滿 | 味 | 魅 | 脈 | 妙 | 民 | 夢 | 夢 | 矛 | 迷 | 鳴 | 免 | 綿 |
| 0DC0 | 模 | 茂 | 毛 | 盲 | 網 | 默 | 紋 | 冶 | 夜 | 務 | 務 | 役 | 藥 | 躍 | 諭 | 輸 |
| 0DE0 | 優 | 友 | 遊 | 郵 | 融 | 譽 | 預 | 幼 | 揚 | 曜 | 洋 | 葉 | 陽 | 養 | 浴 | 翼 |
| 0E00 | 螺 | 来 | 頼 | 欄 | 陸 | 律 | 流 | 留 | 粒 | 旅 | 療 | 稜 | 林 | 臨 | 隣 | 淚 |
| 0E20 | 累 | 励 | 鈴 | 曆 | 歷 | 烈 | 裂 | 勞 | 漏 | 老 | 六 | 脇 | 惑 | 詫 | 湾 | 腕 |
| 0E40 | 幹 | 椅 | 菱 | 宇 | 嘘 | 閱 | 宴 | 欧 | 懷 | 拐 | 涯 | 穫 | 閣 | 渴 | 冠 | 仰 |
| 0E60 | 患 | 汽 | 貴 | 鬼 | 偽 | 戲 | 欺 | 喫 | 窮 | 糾 | 拋 | 漁 | 恐 | 狂 | 仰 | 洪 |
| 0E80 | 緊 | 愚 | 遇 | 靴 | 啓 | 慶 | 憩 | 携 | 擊 | 傑 | 嫌 | 懸 | 嚴 | 雇 | 至 | 誌 |
| 0EA0 | 紅 | 耕 | 航 | 貢 | 挫 | 催 | 栽 | 崎 | 柵 | 搽 | 傘 | 志 | 施 | 旨 | 掌 | 誌 |
| 0EC0 | 識 | 狩 | 趣 | 就 | 秀 | 衆 | 襲 | 蹴 | 充 | 洪 | 緒 | 署 | 諸 | 叙 | 族 | 訟 |
| 0EE0 | 鐘 | 壤 | 織 | 紳 | 醉 | 瀨 | 誠 | 織 | 漸 | 繕 | 塑 | 礎 | 阻 | 奏 | 情 | 情 |
| 0F00 | 戴 | 諾 | 叩 | 旦 | 誕 | 恥 | 仲 | 宙 | 忠 | 抽 | 兆 | 懲 | 抵 | 敵 | 撤 | 党 |
| 0F20 | 盜 | 糖 | 陶 | 鬪 | 督 | 馴 | 霸 | 媒 | 爆 | 縛 | 髮 | 閔 | 泌 | 匹 | 府 | 敷 |
| 0F40 | 仏 | 慕 | 縫 | 乏 | 霧 | 盟 | 勇 | 誘 | 踊 | 裸 | 雷 | 卯 | 里 | 隆 | 慮 | 虞 |
| 0F60 | 寮 | 罌 | 隸 | 靈 | 恋 | 浪 | 郎 | 功 | 坑 | 々 | 々 | 命 | 命 | 命 | 命 | 命 |
| 0F80 | ` | abc | def | ghi | jkl | mno | pqr | rst | stuv | wxyz | { | } | ~ | | | |
| 0FA0 | Б | Г | Д | Ж | З | И | Й | К | Л | М | П | У | Ф | Ц | Ч | Ш |
| 0FC0 | À | Á | Â | Ã | Ä | Å | Ç | È | É | Ê | Ë | Ì | Í | Î | Ï | Ò |
| 0FE0 | Ä | Å | Ö | Û | Ñ | ¿ | ç | è | é | ê | ë | ì | í | î | ï | ñ |

| | 00 | 02 | 04 | 06 | 08 | 0A | 0C | 0E | 10 | 12 | 14 | 16 | 18 | 1A | 1C | 1E |
|------|-----|-----|-----|-----|-----|-----|----|----|----|----|----|-----------------|----------------|-----------------|-----------------|----------------|
| 1000 | A | B | C | D | E | F | G | H | I | J | K | L | M | N | O | P |
| 1020 | Q | R | S | T | U | V | W | X | Y | Z | a | b | c | d | e | f |
| 1040 | g | h | i | j | k | l | m | n | o | p | q | r | s | t | u | v |
| 1060 | w | x | y | z | / | | | | γ | ε | μ | π | φ | ω | Δ | Σ |
| 1080 | Ω | | | | | | | | ガ | ギ | グ | ゲ | ゴ | ザ | ジ | ズ |
| 10A0 | バ | ビ | ブ | ベ | ボ | パ | ピ | プ | ペ | ポ | ヴ | カ | ケ | ク | ケ | ア |
| 10C0 | オ | オ | カ | ガ | キ | ギ | ク | ダ | ア | ゲ | イ | コ | ツ | ウ | サ | エ |
| 10E0 | ス | ズ | セ | ゼ | ソ | ゾ | タ | ダ | チ | ヂ | ッ | ツ | ヅ | テ | デ | ト |
| 1100 | ド | ナ | ニ | ヌ | ネ | ノ | ハ | バ | パ | ヒ | ビ | ピ | フ | ブ | プ | ヘ |
| 1120 | ベ | ペ | ホ | ボ | ポ | マ | ミ | ム | メ | モ | ヤ | ヤ | ユ | ユ | ヨ | ヨ |
| 1140 | ラ | リ | ル | レ | ロ | ワ | ワ | ヲ | ン | ヴ | カ | ケ | ◁ | ▷ | ◁ | ▷ |
| 1160 | — | 、 | 。 | 、 | 、 | 、 | 、 | 、 | 、 | 、 | 、 | 、 | 、 | 、 | 、 | 、 |
| 1180 | — | 、 | 、 | 、 | 、 | 、 | 、 | 、 | 、 | 、 | 、 | 、 | 、 | 、 | 、 | 、 |
| 11A0 | ~ | | | ... | .. | “ | ” | “ | ” | “ | ” | “ | ” | “ | ” | { |
| 11C0 | } | < | > | 《 | 》 | 「 | 」 | 『 | 』 | 【 | 】 | + | - | ± | × | ÷ |
| 11E0 | = | ≠ | < | > | ≤ | ≥ | ∞ | ∴ | ♂ | ♀ | ° | ' | " | ° | ¥ | \$ |
| 1200 | ¢ | £ | % | # | & | * | @ | § | ☆ | ★ | ○ | ● | ◎ | ◇ | ◆ | □ |
| 1220 | ■ | △ | ▲ | ▽ | ▼ | ※ | 〒 | → | ← | ↑ | ↓ | = | □ | △ | ◇ | □ |
| 1240 | 1/1 | 2/2 | 3/3 | 4/4 | 5/5 | 6/6 | ☒ | 00 | mm | cm | km | cm ² | m ² | km ² | cm ³ | m ³ |
| 1260 | mg | kg | cc | dl | ℓ | kl | ms | μs | ns | HP | ps | Hz | ℹ | © | | |
| 1280 | 亜 | 芦 | 尉 | 壹 | 逸 | 芋 | 姻 | 韻 | 詠 | 疫 | 悦 | 調 | 猿 | 毆 | 翁 | 虞 |
| 12A0 | 卸 | 嫁 | 禍 | 彦 | 蚊 | 餓 | 悔 | 塊 | 戒 | 嚇 | 岳 | 檉 | 喝 | 謁 | 轄 | 且 |
| 12C0 | 勘 | 堪 | 棺 | 款 | 憾 | 艦 | 頑 | 忌 | 紀 | 飢 | 棋 | 宜 | 儀 | 吉 | 虐 | 朽 |
| 12E0 | 凶 | 峽 | 恭 | 矯 | 曉 | 斤 | 桐 | 菌 | 謹 | 襟 | 吟 | 限 | 勲 | 薰 | 患 | 溪 |
| 1300 | 螢 | 鷄 | 鯨 | 遣 | 賢 | 繭 | 顯 | 玄 | 孤 | 枯 | 鼓 | 吳 | 悟 | 碁 | 后 | 恒 |
| 1320 | 皇 | 慌 | 醇 | 拷 | 豪 | 獄 | 昆 | 恨 | 紺 | 魂 | 墾 | 懇 | 佐 | 峻 | 詐 | 宰 |
| 1340 | 齋 | 歲 | 搾 | 棧 | 豪 | 慘 | 暫 | 氏 | 司 | 社 | 肢 | 嗣 | 飼 | 雌 | 賜 | 諮 |
| 1360 | 見 | 侍 | 滋 | 慈 | 蚕 | 疾 | 執 | 漆 | 舍 | 赦 | 遮 | 邪 | 飼 | 雌 | 酌 | 爵 |
| 1380 | 寂 | 朱 | 珠 | 儒 | 蠶 | 州 | 宗 | 拾 | 愁 | 酬 | 醜 | 汁 | 蛇 | 勺 | 酌 | 爵 |
| 13A0 | 肅 | 塾 | 俊 | 旬 | 蠶 | 州 | 循 | 潤 | 遵 | 庶 | 如 | 徐 | 銃 | 獸 | 酌 | 爵 |
| 13C0 | 償 | 抄 | 昌 | 晶 | 囚 | 殉 | 宵 | 症 | 祥 | 庶 | 粧 | 徐 | 銃 | 獸 | 酌 | 爵 |
| 13E0 | 償 | 抄 | 昌 | 晶 | 囚 | 殉 | 宵 | 症 | 祥 | 庶 | 粧 | 徐 | 銃 | 獸 | 酌 | 爵 |

| | 00 | 02 | 04 | 06 | 08 | 0A | 0C | 0E | 10 | 12 | 14 | 16 | 18 | 1A | 1C | 1E |
|------|----|----|----|----|----|----|----|----|----|----|----|----|----|----|----|----|
| 1400 | 帥 | 衰 | 睡 | 穗 | 鍾 | 隨 | 髓 | 樞 | 崇 | 菅 | 畝 | 姓 | 齊 | 牲 | 逝 | 婿 |
| 1420 | 脆 | 夕 | 斥 | 隻 | 惜 | 拙 | 竊 | 撰 | 仙 | 踐 | 錢 | 遷 | 薦 | 禪 | 祖 | 租 |
| 1440 | 措 | 疎 | 壯 | 莊 | 桑 | 曹 | 喪 | 葬 | 僧 | 遭 | 槽 | 燥 | 藻 | 霜 | 憎 | 賊 |
| 1460 | 孫 | 馭 | 舵 | 莊 | 泰 | 逮 | 灌 | 沢 | 但 | 丹 | 胆 | 鍛 | 壇 | 痴 | 稚 | 畜 |
| 1480 | 逐 | 窳 | 舩 | 胎 | 著 | 弔 | 眺 | 湖 | 聽 | 勅 | 朕 | 陳 | 鎮 | 津 | 坪 | 渡 |
| 14A0 | 呈 | 窳 | 嫡 | 衷 | 貞 | 帝 | 艇 | 遞 | 偵 | 提 | 送 | 徹 | 童 | 澗 | 斗 | 屯 |
| 14C0 | 奴 | 弟 | 邸 | 亭 | 痘 | 唐 | 塔 | 搭 | 騰 | 豆 | 騰 | 童 | 伯 | 篤 | 篤 | 迫 |
| 14E0 | 豚 | 尼 | 忒 | 妊 | 忍 | 寧 | 婆 | 俳 | 輩 | 梅 | 培 | 陪 | 陪 | 迫 | 漢 | 漢 |
| 1500 | 鉢 | 伐 | 帆 | 畔 | 煩 | 頒 | 藩 | 晚 | 蛮 | 妃 | 披 | 卑 | 碑 | 罷 | 姬 | 漂 |
| 1520 | 苗 | 猫 | 賓 | 頻 | 瓶 | 扶 | 赴 | 膚 | 賦 | 附 | 譜 | 侮 | 覆 | 零 | 墳 | 陸 |
| 1540 | 塤 | 弊 | 遍 | 頻 | 暮 | 邦 | 奉 | 峰 | 抱 | 捧 | 砲 | 褒 | 坊 | 某 | 冒 | 貿 |
| 1560 | 謀 | 朴 | 牧 | 舖 | 堀 | 奔 | 凡 | 盆 | 麻 | 妹 | 埋 | 又 | 抹 | 慢 | 漫 | 岬 |
| 1580 | 眠 | 娘 | 銘 | 墨 | 猛 | 匆 | 厄 | 愉 | 癒 | 唯 | 幽 | 悠 | 猶 | 裕 | 雄 | 憂 |
| 15A0 | 羊 | 庸 | 窳 | 妄 | 謠 | 翌 | 羅 | 齡 | 濫 | 吏 | 痢 | 履 | 柳 | 竈 | 疏 | 涼 |
| 15C0 | 獵 | 陵 | 僚 | 糧 | 厘 | 倫 | 零 | 齡 | 麗 | 廉 | 鍊 | 爐 | 露 | 竈 | 廊 | 樓 |
| 15E0 | 賄 | 國 | 搖 | 條 | 櫻 | 澤 | 瀘 | 碌 | 緞 | 鐵 | 靱 | 靖 | 楳 | 浩 | 郁 | |

2

HARDWARE

This chapter describes the printed circuit boards of the CNC control unit and card PCB functions on the printed circuit boards. The chapter also describes procedures for replacing consumable items.

| | | |
|------|---|-----|
| 2.1 | HARDWARE CONFIGURATION | 157 |
| 2.2 | HARDWARE OVERVIEW | 158 |
| 2.3 | TOTAL CONNECTION DIAGRAMS | 160 |
| 2.4 | CONNECTOR AND CARD CONFIGURATIONS OF PRINTED CIRCUIT BOARDS | 163 |
| 2.5 | UNITS AND PRINTED CIRCUIT BOARDS | 200 |
| 2.6 | REPLACING THE MAIN BOARD | 204 |
| 2.7 | MOUNTING AND DEMOUNTING CARD PCBS | 208 |
| 2.8 | MOUNTING AND DEMOUNTING DIMM MODULES | 211 |
| 2.9 | REPLACING FUSE ON CONTROL UNIT | 213 |
| 2.10 | REPLACING BATTERY | 215 |
| 2.11 | REPLACING FAN MOTORS | 222 |
| 2.12 | REPLACING LCD BACKLIGHT | 225 |
| 2.13 | DISTRIBUTED I/O SETTING | 234 |
| 2.14 | REPLACING FUSES ON VARIOUS UNITS | 236 |
| 2.15 | ENVIRONMENTAL REQUIREMENTS OUTSIDE THE CONTROL UNIT | 239 |
| 2.16 | ACTION AGAINST NOISE | 240 |

2.1 HARDWARE CONFIGURATION

Series 0i Mate-C system configuration

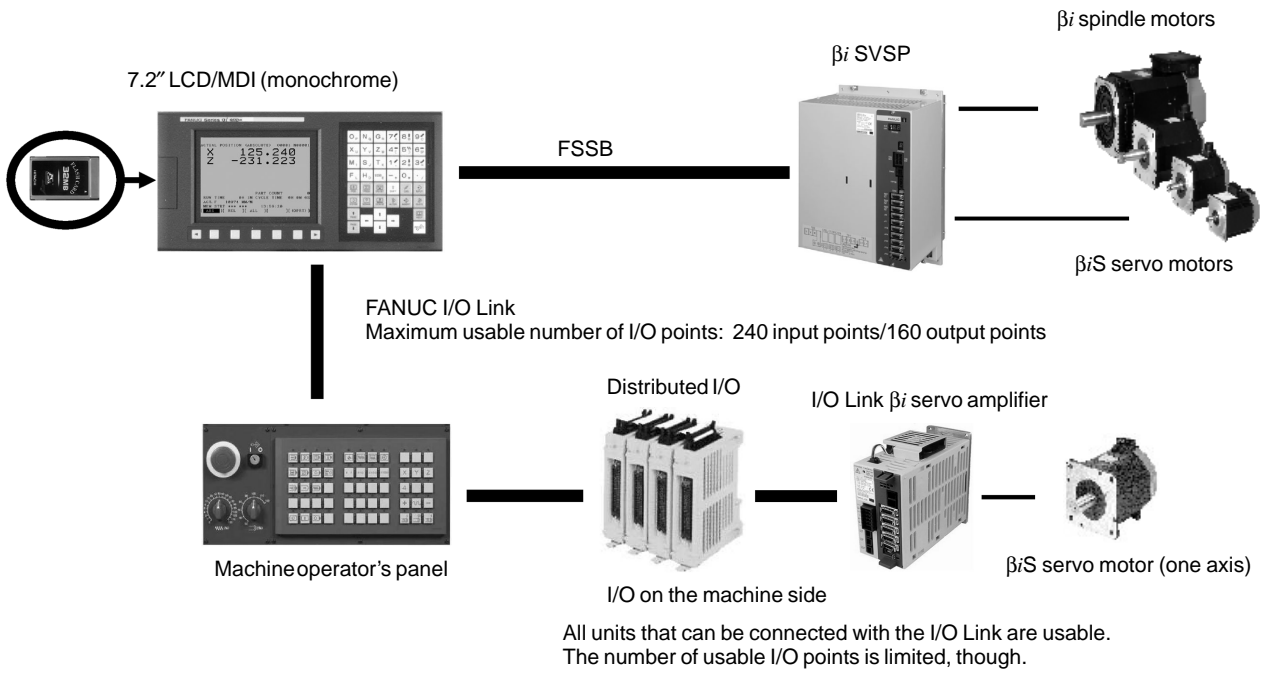

Series 0i-C system configuration

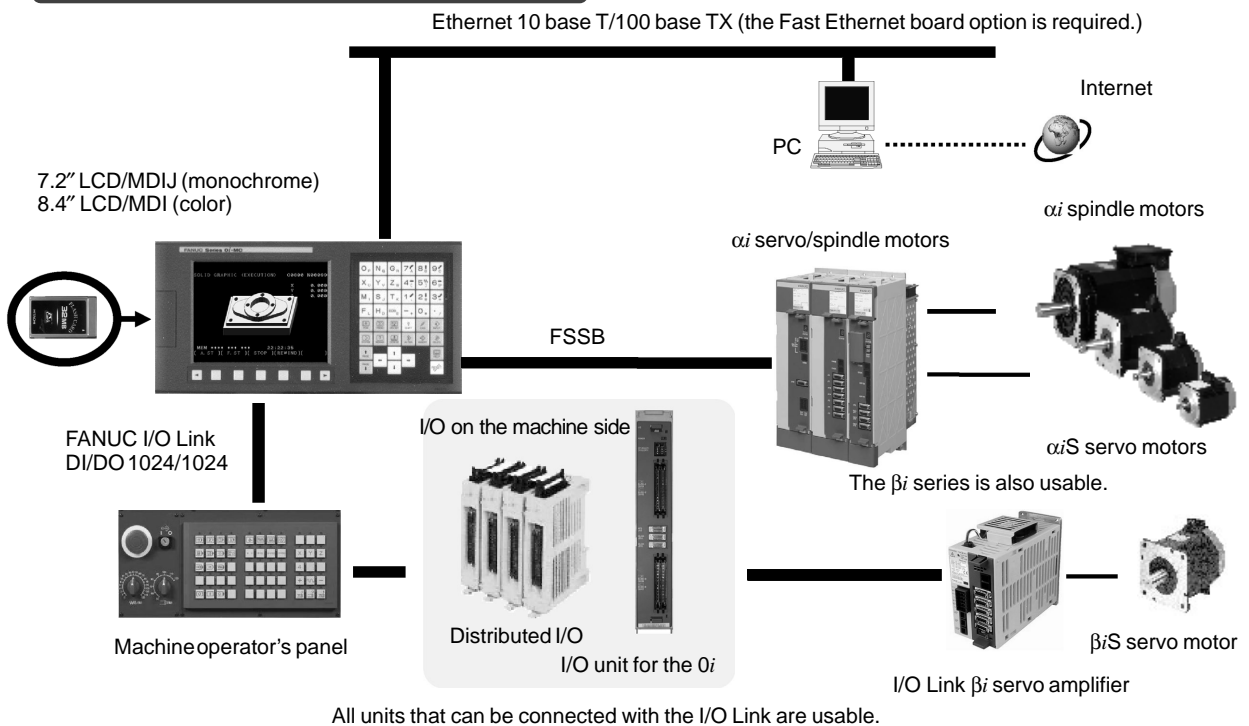

2.2 HARDWARE OVERVIEW

There are two types of basic units for Series 0i-C and Series 0i Mate-C:

| Basic unit drawing No. | Model |
|---|--|
| A02B-0309-B50n(n=0,1,...,9) A02B-0311-B50n(n=0,1,...,9) A02B-0311-B51n(n=0,1,...,9) | Series 0i -C Series 0i Mate-C Series 0i Mate-C |
| A02B-0309-B52n(n=0,1,...,9) A02B-0311-B52n(n=0,1,...,9) A02B-0311-B53n(n=0,1,...,9) | Series 0i -C Series 0i Mate-C Series 0i Mate-C |

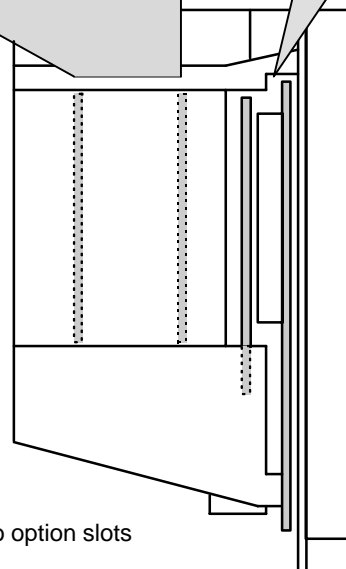
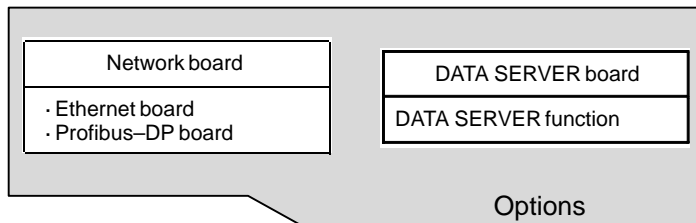
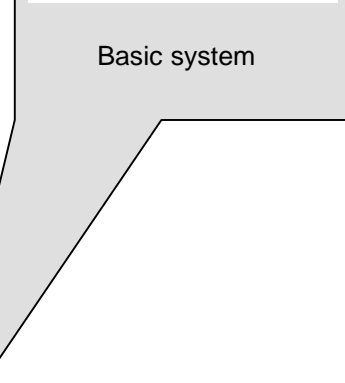
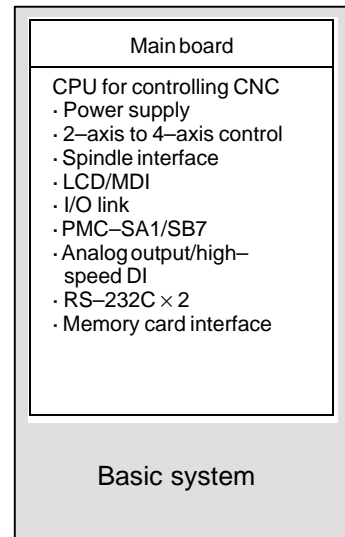

The control unit for the Series 0i has two option slots or no option slots.

The control unit for the Series 0i Mate has no option slots, so an option board cannot be added. On a unit with option slots, as many option boards as the number of option slots can be mounted. (However, the option board must satisfy the mounting conditions. See the mounting conditions for additional options.)

Fig. 2.2 Configuration of the control unit (Series 0i/0i Mate)

Conditions for installing options

| | Option | Slot nearest to the LCD |
|-------------|---|-------------------------|
| Data server | Data server board (ATA flash card and 100BASE-TX) 10BASE-T is also enabled <div style="border: 1px solid black; padding: 2px; display: inline-block;">Ethernet and data server functions</div> | × |
| Network | Ethernet board (100BASE-TX) 10BASE-T is also enabled <div style="border: 1px solid black; padding: 2px; display: inline-block;">Ethernet function</div> + <div style="border: 1px solid black; padding: 2px; display: inline-block;">Function - FOCASI/DNC1/FACTOLINK</div> | × |
| | PROFIBUS board <div style="border: 1px solid black; padding: 2px; display: inline-block;">PROFIBUS function</div> + <div style="border: 1px solid black; padding: 2px; display: inline-block;">PROFIBUS application</div> + <div style="border: 1px solid black; padding: 2px; display: inline-block;">Master /slave</div> | |

**CAUTION**

Each option listed above occupies one option slot. These option slots do not necessarily accept all option types. When selecting option slots, therefore, pay attention to the number of option slots. In this table, the symbol “×” indicates the option slot that does not accept the indicated options. Some combinations of options are unacceptable.

2.3 TOTAL CONNECTION DIAGRAMS

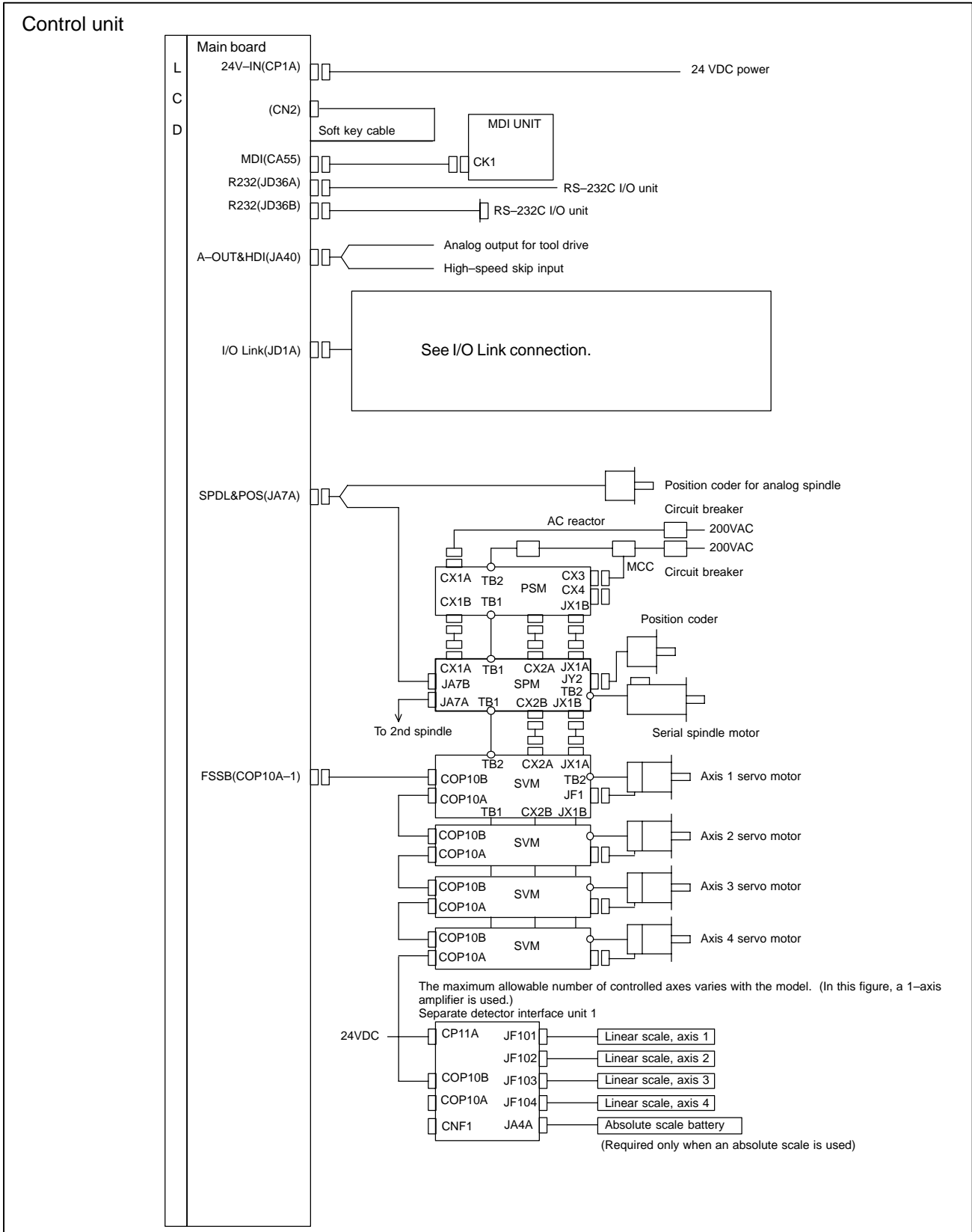

Control unit (Only when the Series 0i has an option function)

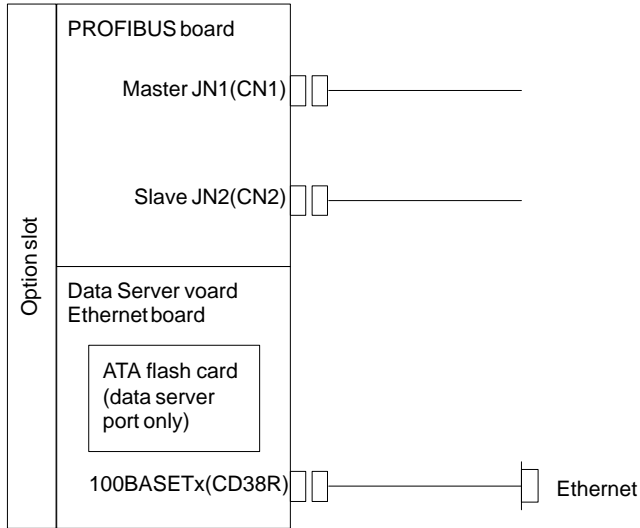

Sample I/O Link connection

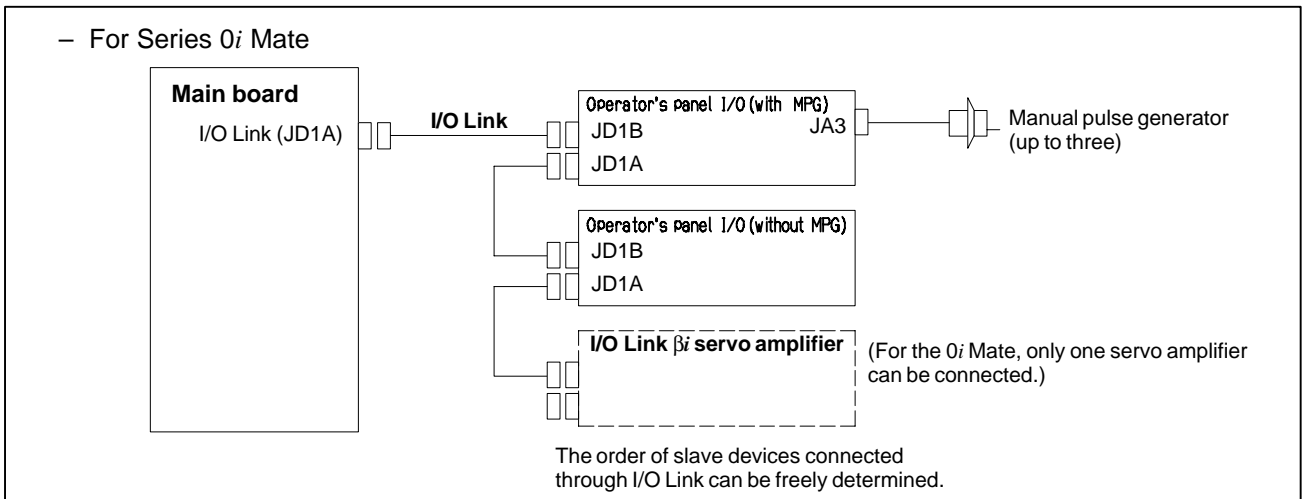
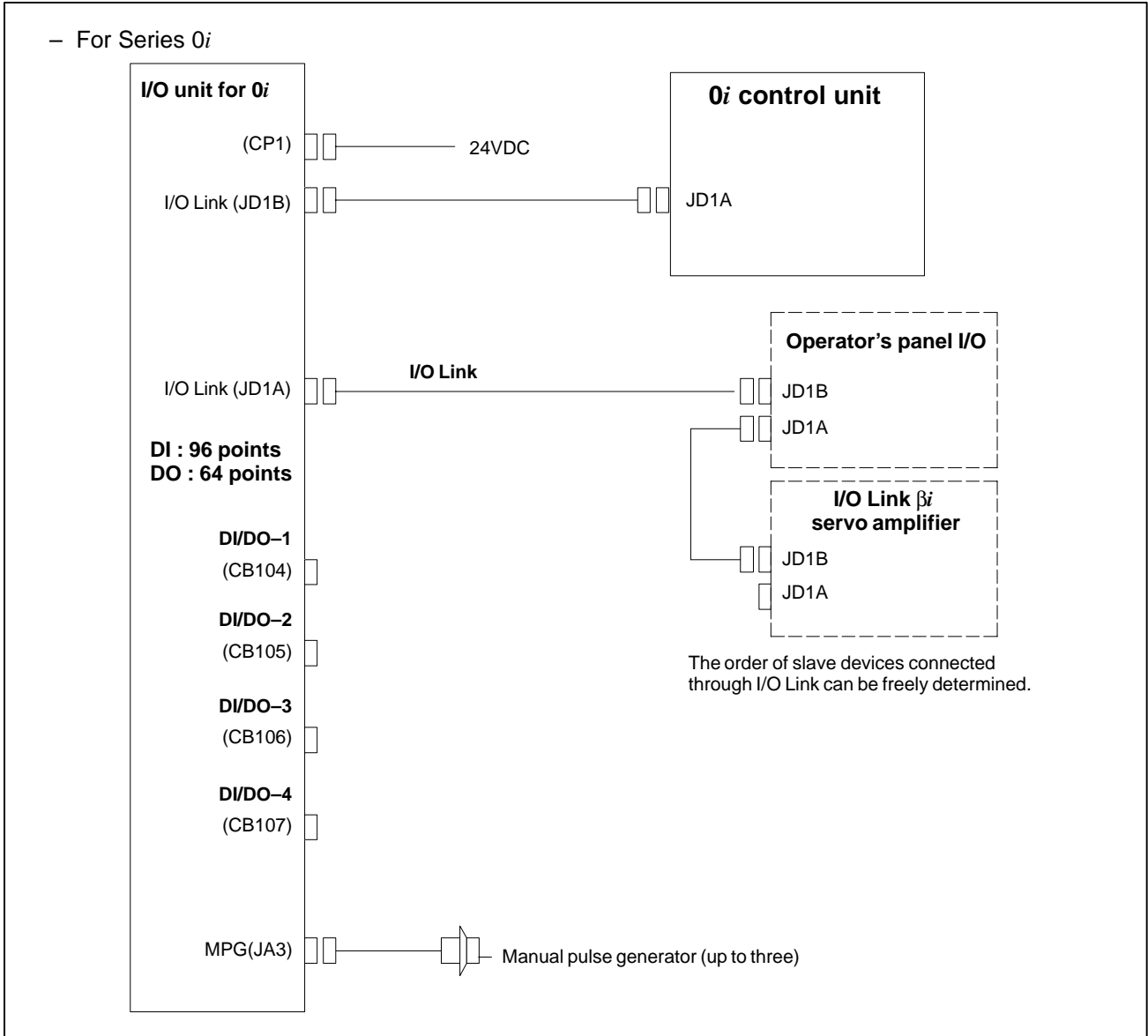

2.4 CONNECTOR AND CARD CONFIGURATIONS OF PRINTED CIRCUIT BOARDS

2.4.1 Main Board

For the Series 0i/0i Mate-C, two types of basic unit are available. The explanation differs depending on the drawing number of the basic unit. Refer to the description on the appropriate page to refer to.

| Model | Drawing number of the basic unit | Page to refer to |
|--|---|------------------|
| Series 0i -C Series 0i Mate-C Series 0i Mate-C | A02B-0309-B50n(n=0,1,...,9) A02B-0311-B50n(n=0,1,...,9) A02B-0311-B51n(n=0,1,...,9) | Page 164 to 169 |
| Series 0i -C Series 0i Mate-C Series 0i Mate-C | A02B-0309-B52n(n=0,1,...,9) A02B-0311-B52n(n=0,1,...,9) A02B-0311-B53n(n=0,1,...,9) | Page 170 to 177 |

NOTE

For information on basic units, see page 2 of the "Introduction" chapter.

● Specifications

| Item | Code |
|---|----------------|
| Main board of Series 0i-C (for PMC-SA1) | A20B-8101-0280 |
| Main board of Series 0i-C (for PMC-SB7) | A20B-8101-0281 |
| Main board of Series 0i-Mate C | A20B-8101-0285 |

● Mounting positions of connectors

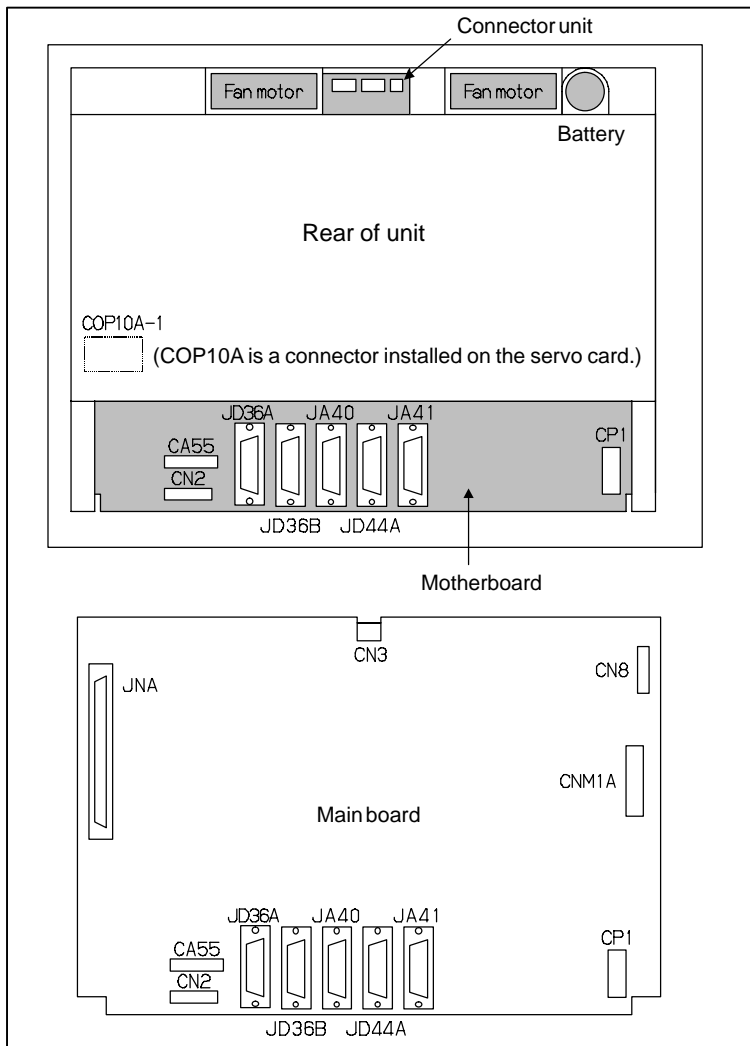

| Connector number | Application |
|------------------|-------------------------------|
| COP10A-1 | Servo interface (FSSB) |
| CA55 | MDI |
| JD36A | RS-232C serial port |
| JD36B | RS-232C serial port |
| JA40 | Analog output/high-speed DI |
| JD44A | I/O link |
| JA41 | Serial spindle/position coder |
| CP1 | 24VDC-IN |

- **Card and power supply mounting location**

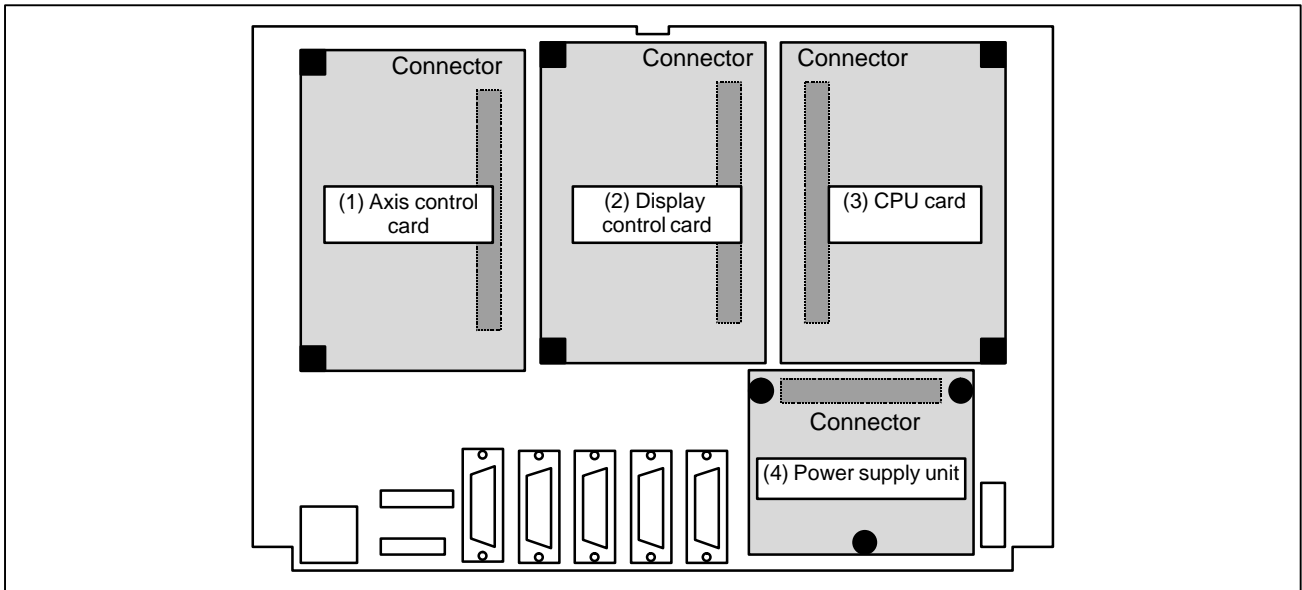

- **DIMM module mounting location**

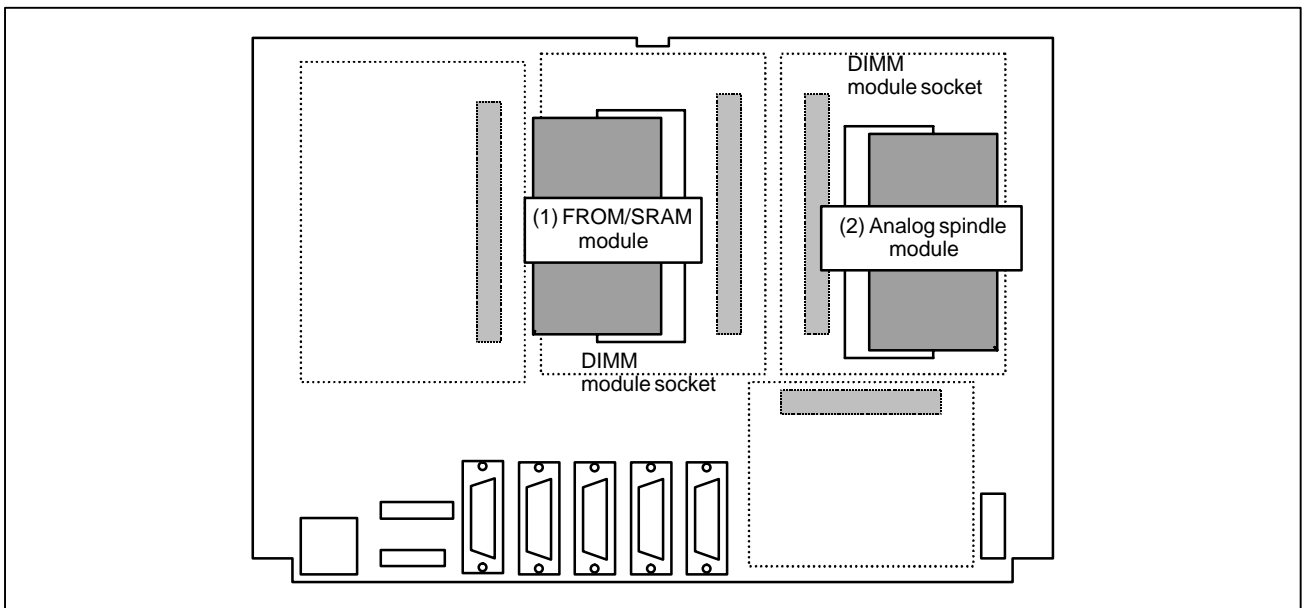

| No. | Item | Code | Function | Remarks |
|-----|-----------------------|----------------|---|--|
| (1) | Axis control card | A20B-3300-0393 | Two axes control | |
| | | A20B-3300-0392 | Four axes control | |
| (2) | Display control card | A20B-3300-0280 | 10.4" color LCD | |
| | | A20B-3300-0281 | 8.4" color LCD | |
| | | A20B-3300-0283 | 7.2" monochrome LCD | |
| (3) | CPU card | A20B-3300-0291 | DRAM 16MB 486 | |
| | | A20B-3300-0290 | DRAM 32MB 486 | 0i-C only |
| | | A20B-3300-0313 | DRAM 32MB Pentium | 0i-C only |
| (4) | Power supply unit | A20B-8101-0180 | | |
| (5) | FROM/SRAM module | A20B-3900-0163 | FROM 32MB SRAM 1MB | FROM stores various control software products. SRAM is backed up by a battery. |
| (6) | Analog spindle module | A20B-3900-0170 | Analog spindle control position coder interface | |

● Block diagram

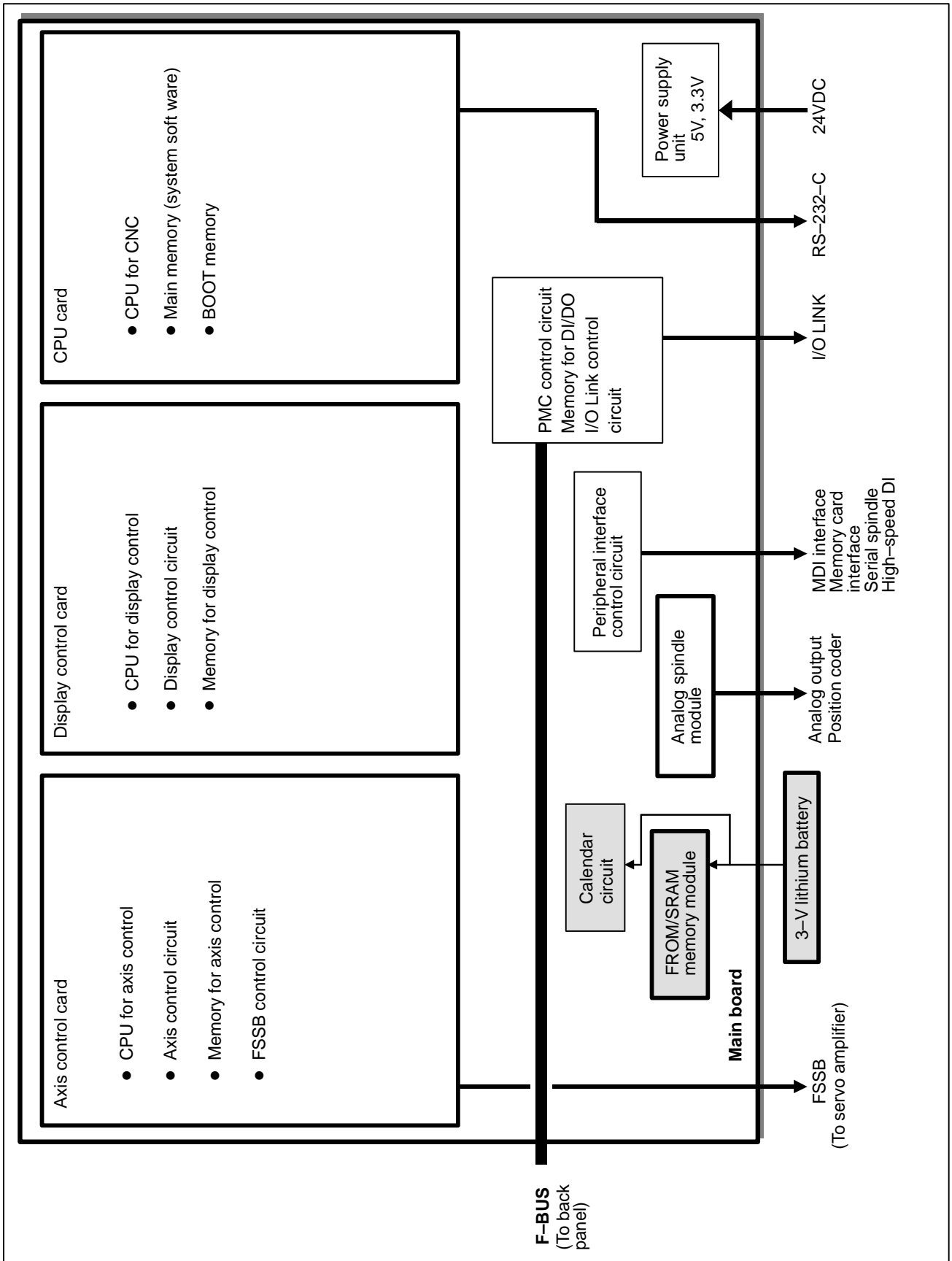

● LED display

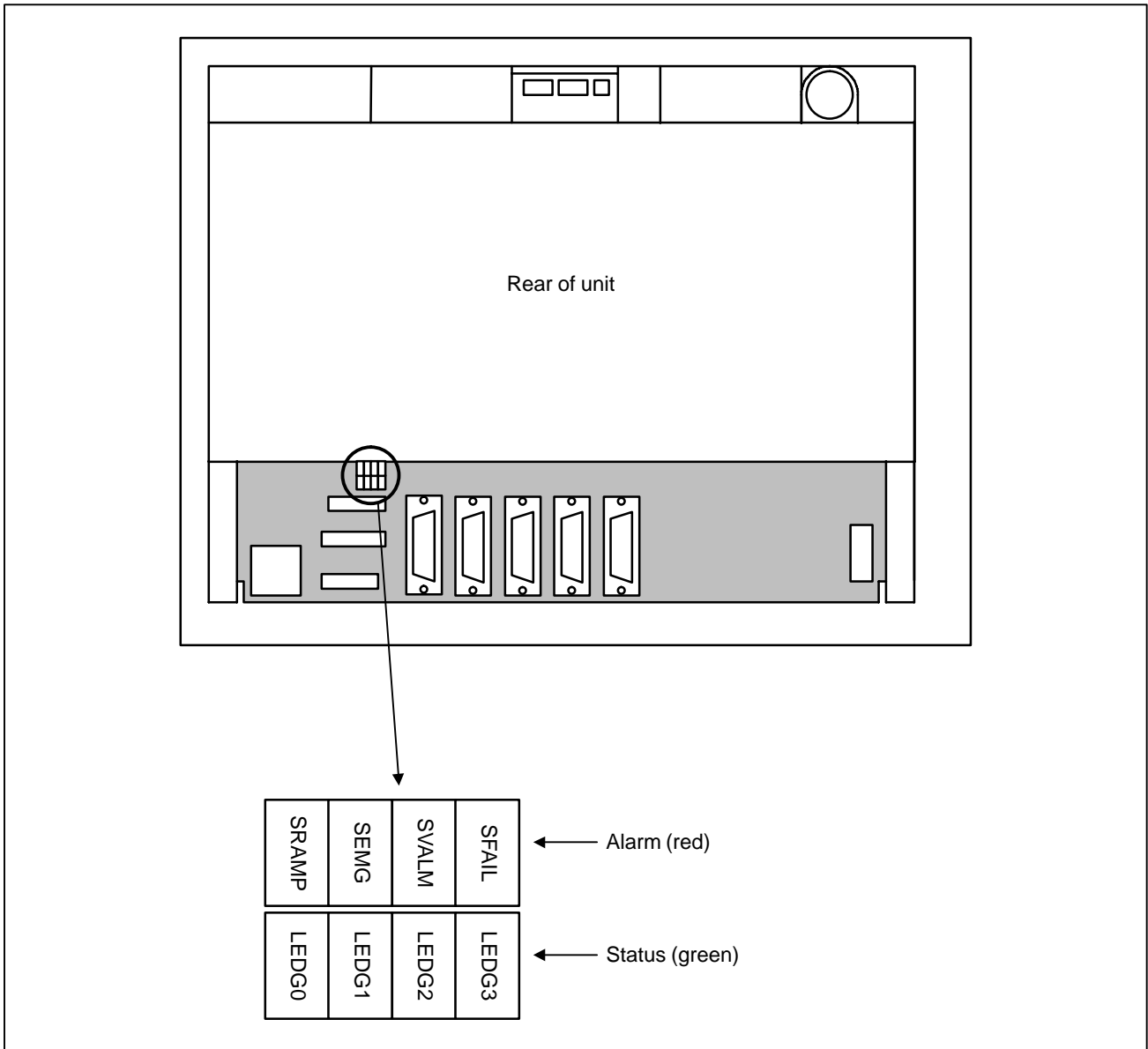

(1) Changes in status LED (green) indication at power-on time

| No. | Status LED | Status |
|-----|------------|---|
| 1 | □□□□ | Power is not supplied. |
| 2 | ■ ■ ■ ■ | Initial status immediately after power is switched on; boot is running. |
| 3 | □ ■ ■ ■ | System activation started. |
| 4 | ■ □ ■ ■ | Waiting for each processor ID in the system to be set up. |
| 5 | □ □ ■ ■ | Each processor ID in the system has been set up. |
| 6 | ■ ■ □ ■ | FANUC bus initialized. |
| 7 | □ ■ □ ■ | PMC initialized. |
| 8 | ■ □ □ ■ | Information about the hardware configuration of each printed-circuit board in the system has been set up. |
| 9 | □ □ □ ■ | PMC ladder initialized. |
| 10 | □ ■ ■ □ | Waiting for digital servo to be initialized. |
| 11 | ■ ■ ■ □ | Digital servo initialized. |
| 12 | ■ □ □ □ | Initialization is completed, and normal operation is in progress. |

■: On □: Off

(2) Alarm LED (red) indication at system alarm occurrence

If any of these LEDs lights, it is likely that the hardware is defective.

| Alarm LED | Meaning |
|-----------|--|
| SVALM | Servo alarm. |
| SEMG | Lights when a system alarm occurs. The hardware has detected a failure in the system. |
| SFAIL | Lights when a system alarm occurs. Used by the software to stop the system. Lights while boot is under way. |
| SRAMP | RAM parity or ECC alarm. |

Main Board

- Specifications

| Item | Code |
|---|----------------|
| Main board of Series 0i-C (PMC-SA1 CPU: Pentium DRAM: 32MB) | A20B-8200-0380 |
| Main board of Series 0i-C (PMC-SB7 CPU: Pentium DRAM: 32MB) | A20B-8200-0381 |
| Main board of Series 0i-C (PMC-SB7 CPU: 486 DRAM: 32MB) | A20B-8200-0391 |
| Main board of Series 0i-C (PMC-SA1 CPU: 486 DRAM: 32MB) | A20B-8200-0390 |
| Main board of Series 0i-Mate C (PMC-SA1 CPU: 486 DRAM: 16MB) | A20B-8200-0395 |

- Mounting positions of connectors

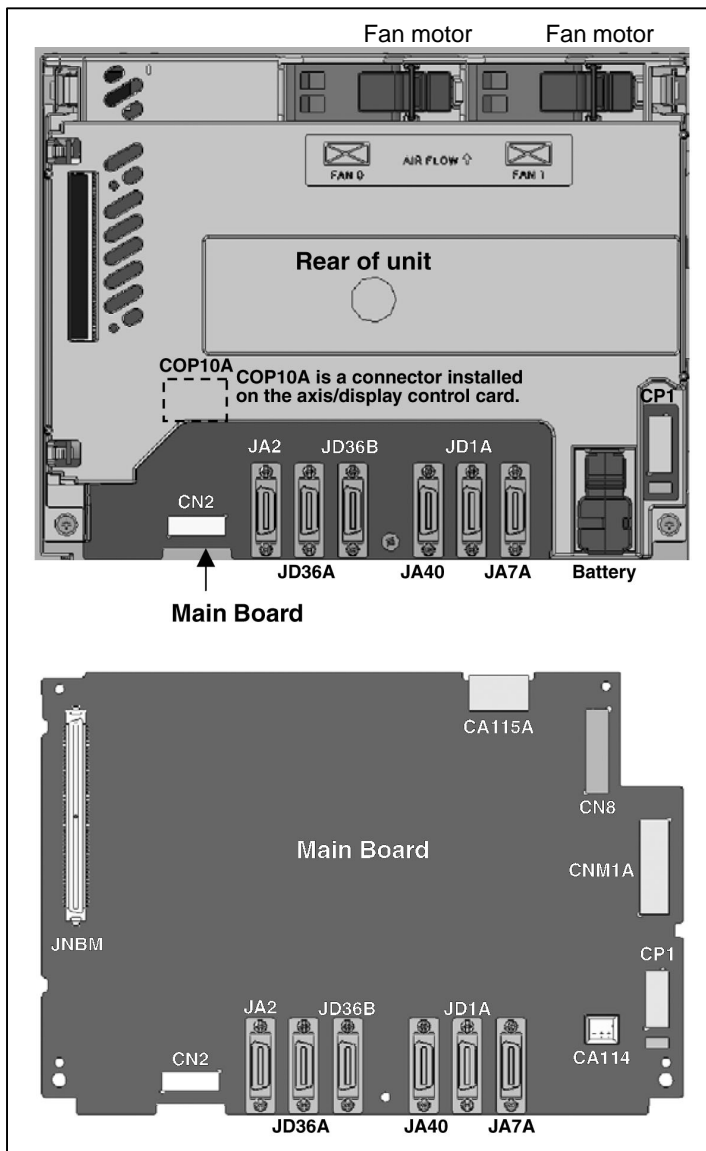

| Connector number | Application |
|------------------|-------------------------------|
| COP10A | Servo interface (FSSB) |
| JA2 | MDI |
| JD36A | RS-232C serial port |
| JD36B | RS-232C serial port |
| JA40 | Analog output/high-speed DI |
| JD1A | I/O link |
| JA7A | Serial spindle/position coder |
| CP1 | Input power supply DC24V-IN |

- **Card and power supply mounting location**

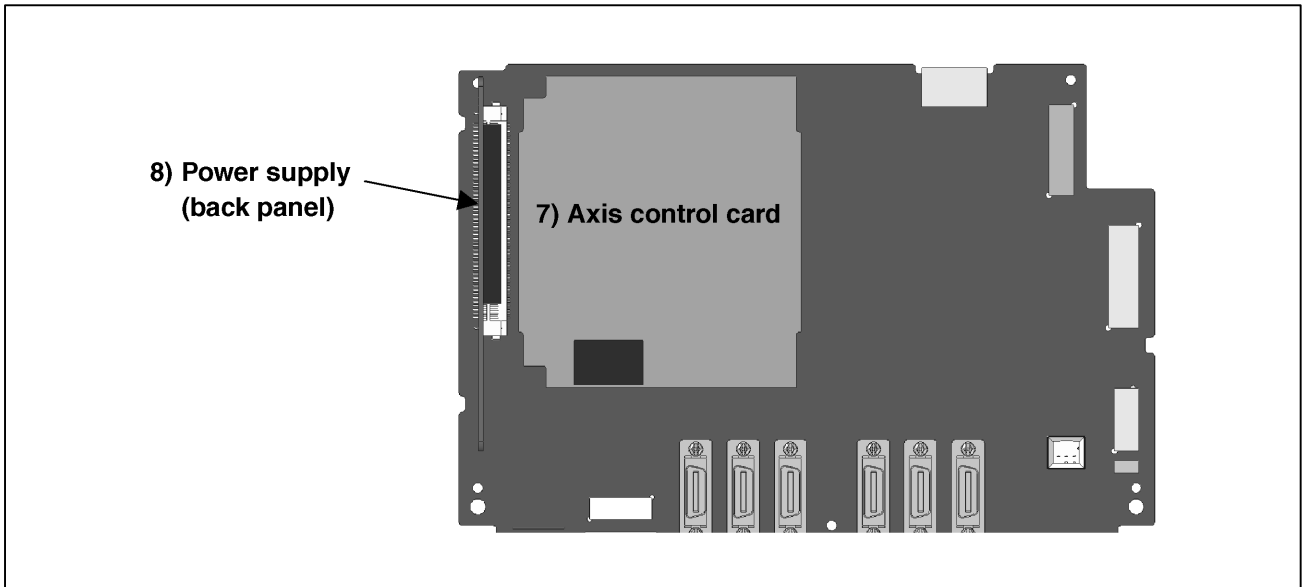

- **DIMM module mounting location**

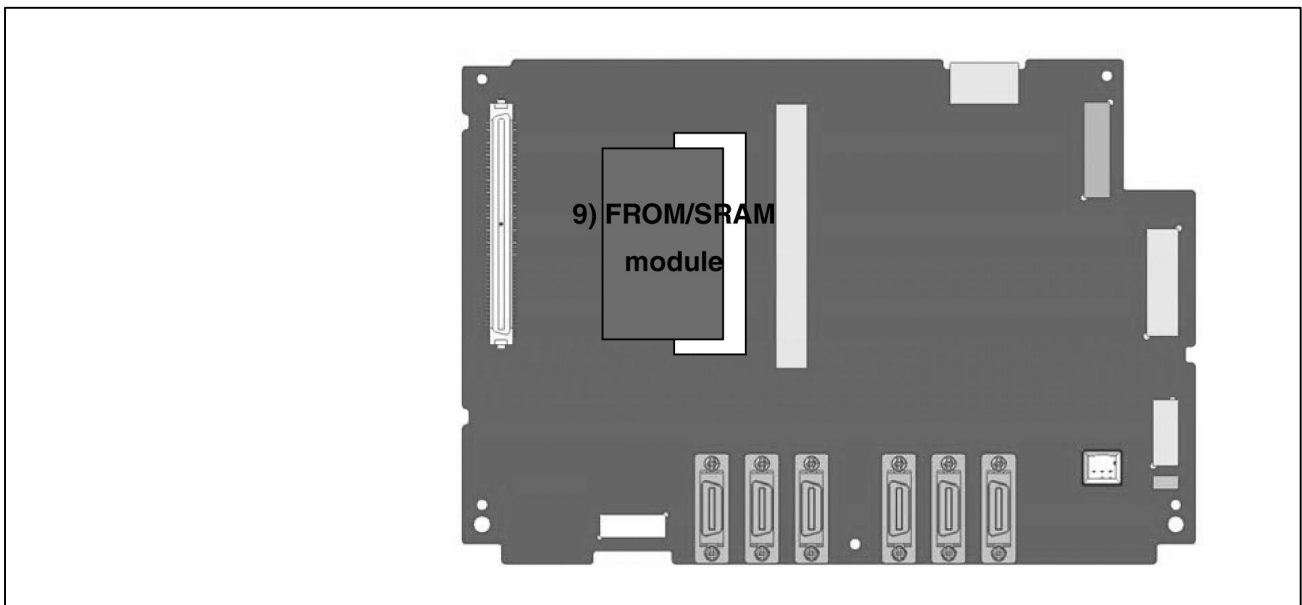

| No. | Item | Code | Function | Remarks |
|------|-----------------------------------|----------------|-------------------------|--|
| (7) | Axis control card | A20B-8200-0360 | Two axes control | |
| | | A20B-8200-0361 | Four axes control | |
| (8) | Power supply card (back panel) | A20B-8101-0430 | For non slot | |
| | | A20B-8101-0440 | For two slots | 0i-C only |
| (9) | FROM/SRAM module | A20B-3900-0163 | FROM: 32MB SRAM: 1MB | FROM stores various control software products. SRAM is backed up by a battery. |
| (10) | Inverter | A20B-8002-0631 | For 7.2" monochrome LCD | |
| | | A20B-8002-0632 | For 10.4" color LCD | |
| | | A20B-8002-0633 | For 8.4" color LCD | |

• For new type basic unit

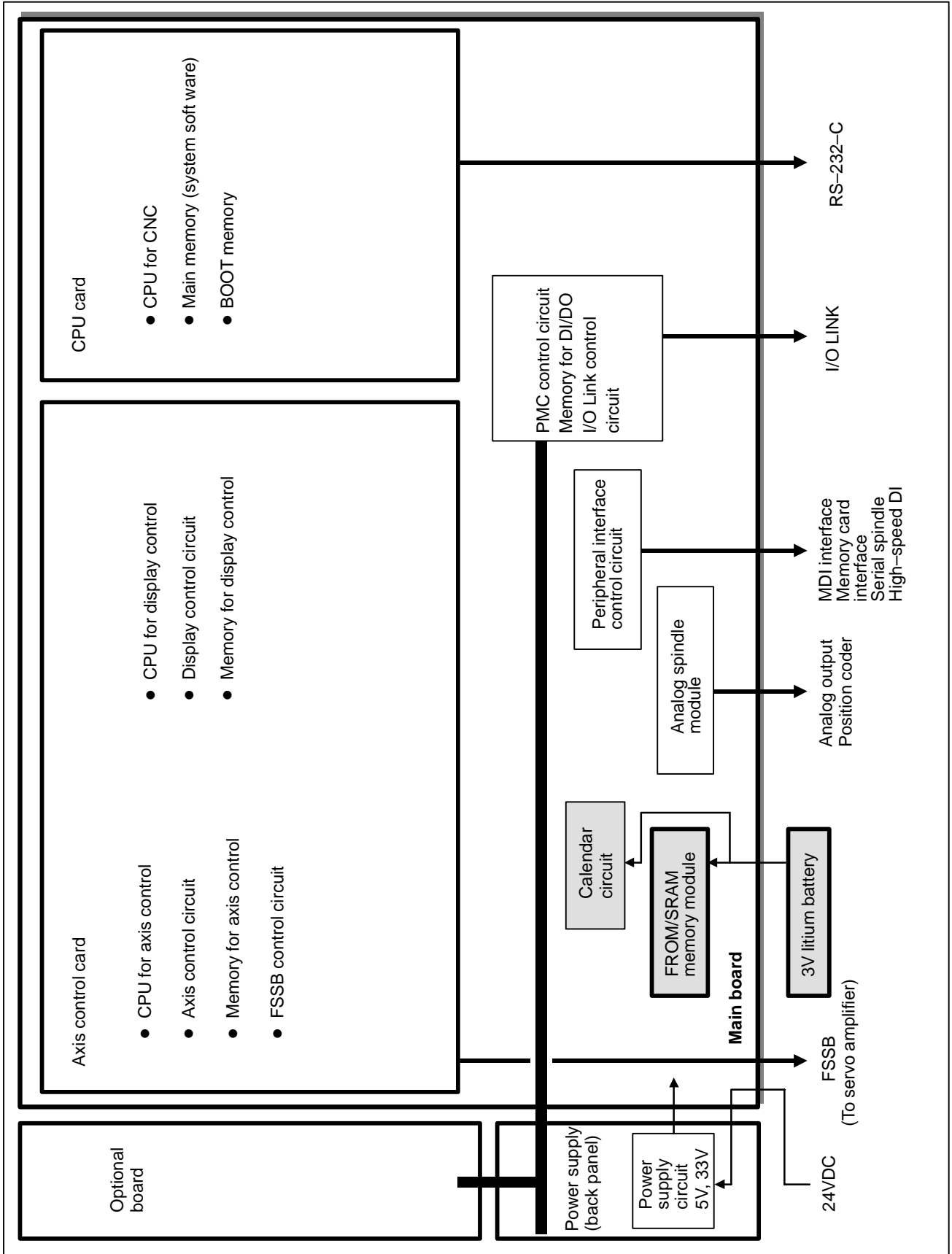

• LED display

For main board of A20B-8200-0380 or A20B-8200-0381

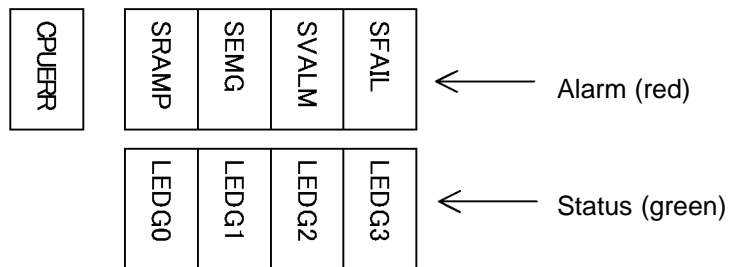
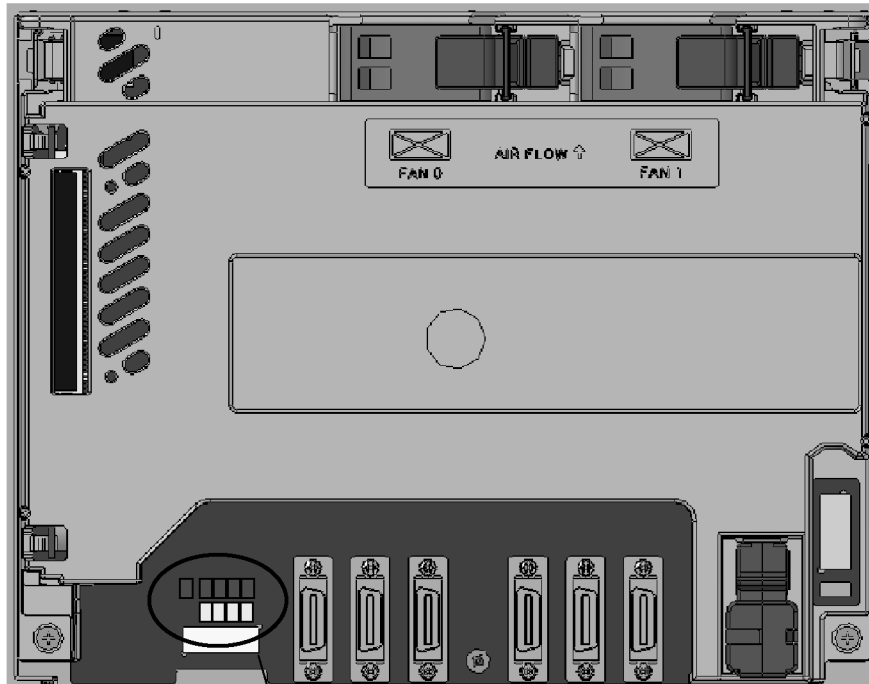

For main board of A20B-8200-0390, A20B-8200-0391, or A20B-8200-0395

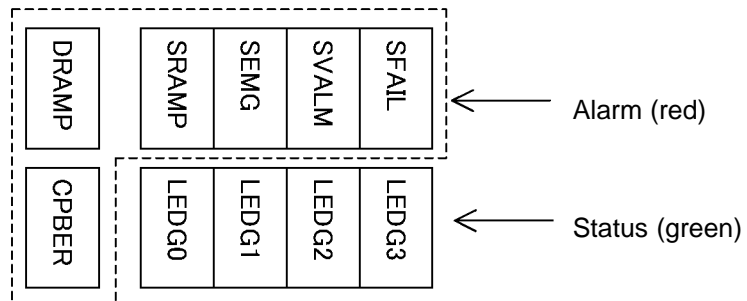
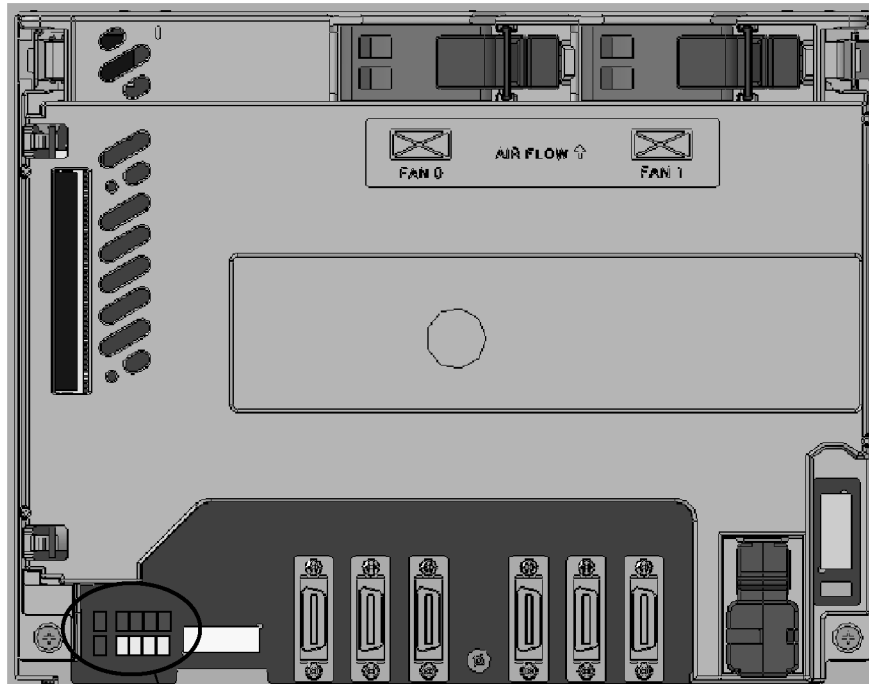

(1) Changes in status LED (green) indication at power-on time

| No. | Status LED | Status |
|-----|------------|---|
| 1 | □□□□ | Power is not supplied. |
| 2 | ■ ■ ■ ■ | Initial status immediately after power is switched on; boot is running. |
| 3 | □ ■ ■ ■ | System activation started. |
| 4 | ■ □ ■ ■ | Waiting for each processor ID in the system to be set up. |
| 5 | □ □ ■ ■ | Each processor ID in the system has been set up. |
| 6 | ■ ■ □ ■ | FANUC bus initialized. |
| 7 | □ ■ □ ■ | PMC initialized. |
| 8 | ■ □ □ ■ | Information about the hardware configuration of each printed-circuit board in the system has been set up. |
| 9 | □ □ □ ■ | PMC ladder initialized. |
| 10 | □ ■ ■ □ | Waiting for digital servo to be initialized. |
| 11 | ■ ■ ■ □ | Digital servo initialized. |
| 12 | ■ □ □ □ | Initialization is completed, and normal operation is in progress. |

■: On □: Off

(2) Alarm LED (red) indication at system alarm occurrence

If any of these LEDs lights, it is likely that the hardware is defective.

| Alarm LED | Meaning |
|-----------|--|
| SVALM | Servo alarm. |
| SEMG | Lights when a system alarm occurs. The hardware has detected a failure in the system. |
| SFAIL | Lights when a system alarm occurs. Used by the software to stop the system. Lights while boot is under way. |
| SRAMP | RAM parity or ECC alarm. |

(3) Alarm LED (red) indication at system alarm occurrence

For A20B-8200-0380 or A20B-8200-0381

If this LED lights, it is likely that the hardware is defective.

| Alarm LED | Meaning |
|-----------|--|
| CPUERR | When the LED lights: A DRAM parity alarm has been detected. When the LED blinks: A bus error has been detected. |

For A20B-8200-0390, A20B-8200-0391, or A20B-8200-0395

If any of these LED lights, it is likely that the hardware is defective.

| Alarm LED | Meaning |
|-----------|--|
| DRAMP | A DRAM parity alarm has been detected. |
| CPUERR | A bus error has been detected. |

2.4.2 Inverter PCBs

- Connector Units

For the Series *0i/0i* Mate-C, two types of basic unit are available. The explanation differs depending on the drawing number of the basic unit.

| Drawing number of the basic unit | | A02B-0309-B50n A02B-0311-B50n A02B-0311-B51n (n=0,1,...,9) | A02B-0309-B52n A02B-0311-B52n A02B-0311-B53n (n=0,1,...,9) |
|----------------------------------|--------------------------------|---|---|
| Inverter P.C.B | For 7.2" monochrome LCD | A20B-8100-0710 | A20B-8002-0631 |
| | For 8.4" color LCD | A20B-8001-0922 | A20B-8002-0633 |
| | For 10.4" color LCD | A20B-8001-0920 | A20B-8002-0632 |
| Connector unit | For unit with no option slot | A15L-0001-0060#B | Not existent. |
| | For unit with two option slots | A15L-0001-0060#A | |

NOTE

See Section 2.2, "HARDWARE OVERVIEW."
The connector unit is fastened to the case with self-tapping screws.

- Connector location
(For A20B-8100-0710, A20B-8001-0922, and A20B-8001-0920)

(1) With 2 slots

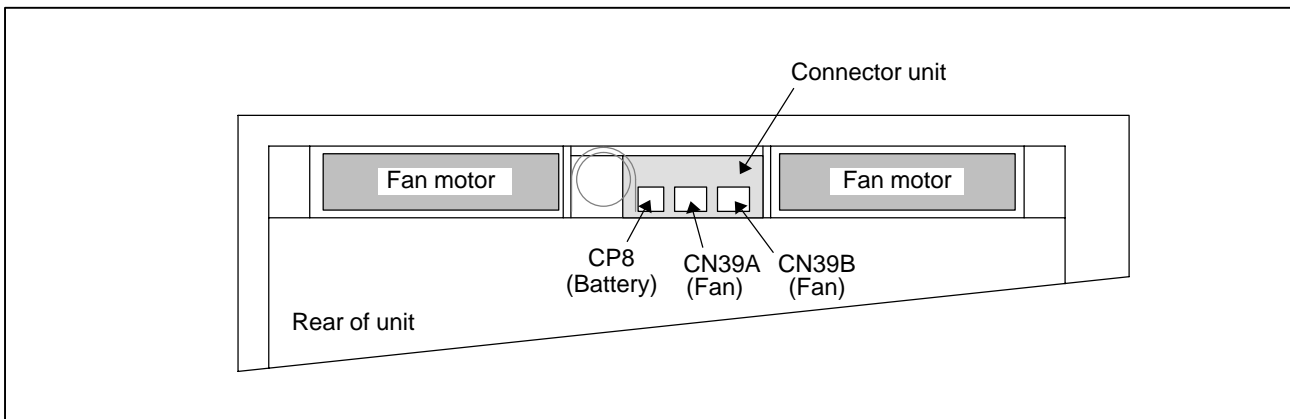

(2) With no slot

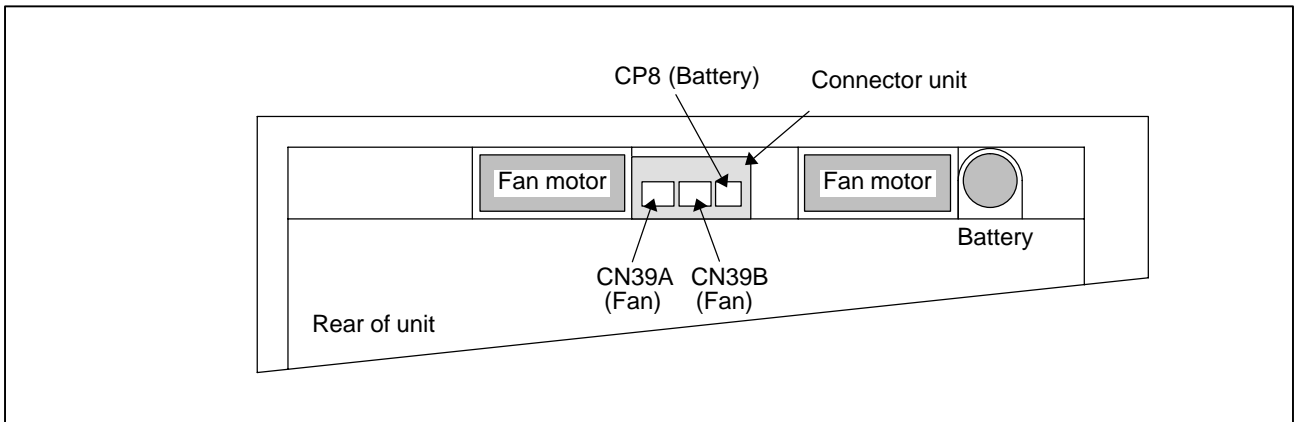

2.4.3 Fast Ethernet Board

For the Series 0i-C, two types of basic unit are available.
The usable board differs depending on the basic unit.
In this manual, boards are classified as “Fast Ethernet board A” and “Fast Ethernet board B” for the sake of convenience.

| Drawing number of the basic unit | Fast Ethernet board |
|----------------------------------|-----------------------|
| A02B-0309-B50n(n=0,1,...,9) | Fast Ethernet board A |
| A02B-0309-B52n(n=0,1,...,9) | Fast Ethernet board B |

Fast Ethernet board A

| Name | Specification |
|---------------------|----------------|
| Fast ethernet board | A20B-8100-0770 |

NOTE

The Ethernet board cannot fit into the option slot nearest to the LCD.

• Connector location

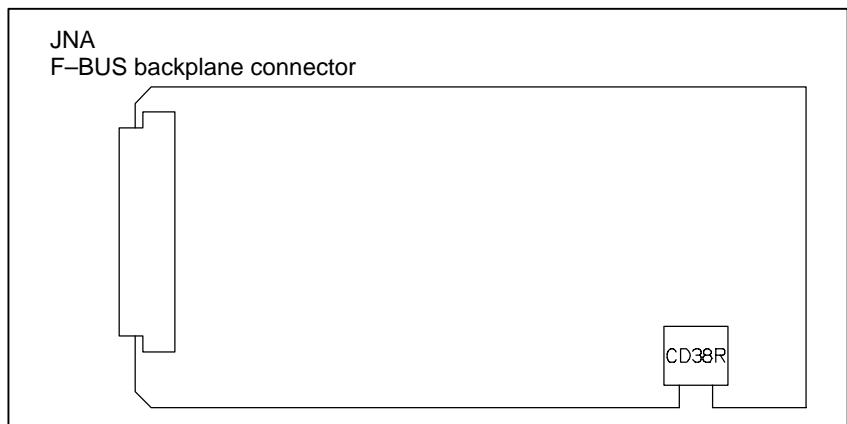

| Connector number | Application |
|------------------|-------------------------------|
| CD38R | 100BASE-TX Ethernet interface |

• Card location

No card is mounted on the Ethernet board.

● LED indication

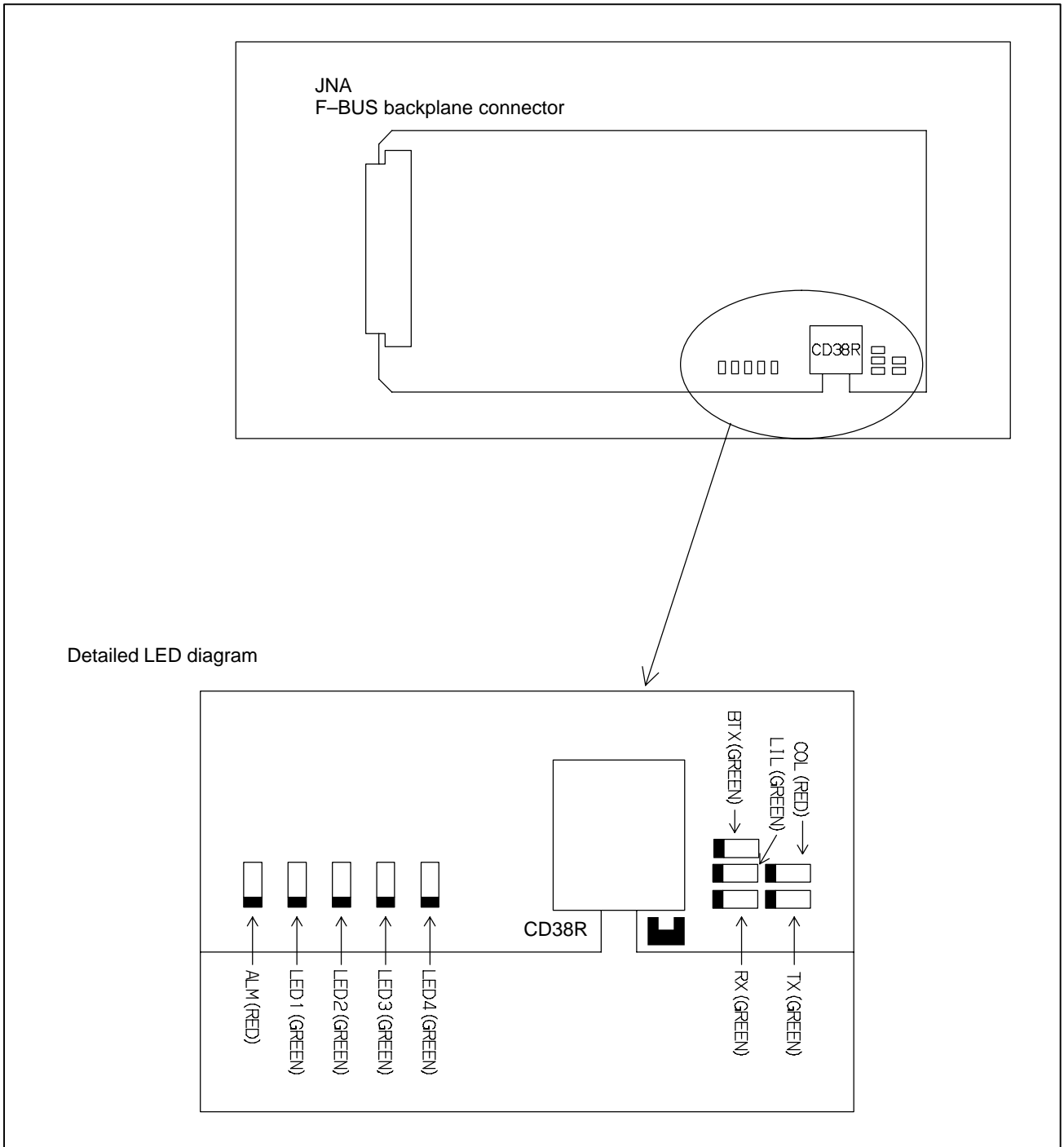

● LED indication transition at power-on time

| No. | LED indication 1234 | Ethernet board status |
|-----|------------------------|--|
| 1 | STATUS □□□□ | Power off |
| 2 | STATUS ■■■■ | Initial status immediately after power is switched on. |
| 3 | STATUS □■■■ | MPU initialization completed. |
| 4 | STATUS □□■■ | Firmware download completed. |
| 5 | STATUS □□□■ | Control passed to the OS. |
| 6 | STATUS ■■■□ | OS PHASE 1 |
| 7 | STATUS □■■□ | OS PHASE 2 |
| 8 | STATUS ■□■□ | OS PHASE 3 |
| 9 | STATUS □□■□ | OS PHASE 4 |
| 10 | STATUS ☆□□□ | Start sequence completed. |

When the Ethernet board is started normally, the STATUS LEDs light as shown at No. 10. This condition is preserved unless an abnormal condition occurs.

● STATUS LED indications if an error occurs

If an error occurs, the STATUS LEDs repeatedly flash “LONG” then “SHORT.” (For “LONG,” the LED lights for a long time. For “SHORT,” the LED lights for a short time.)

| No. | STATUS LED indication | | Board state | |
|-----|-----------------------|---------------|----------------------------------|-----------------------------|
| | LONG 1234 | SHORT 4321 | | |
| 1 | □□■■ | ■■□□ | Failure caused by this board. | SRAM parity alarm |
| 2 | □■□■ | □□□□ | | General invalid instruction |
| 3 | □■□■ | ■□□□ | | Invalid slot instruction |
| 4 | □□■■ | ■□□□ | Failure caused by another board. | NMI of another module |

NOTE

If an error, indicated by repeatedly flashing a LONG and SHORT combination other than the above, occurs, contact FANUC.

● ALARM LED indications if an error occurs

| No. | LED indication | Board state |
|-----|-------------------------|----------------------------------|
| 1 | ALM ■ | Parity error occurred in memory. |

- LED indications related to communication status

| No. | LED indication | Board state |
|-----|----------------|---|
| 1 | RX/TX ■ | Lights when data is received or sent. |
| 3 | LIL ■ | Lights when the board is successfully connected to the hub. |
| 4 | COL ■ | Lights if a data collision occurs. |
| 5 | BTX ■ | Lights when a connection is made with 100BASE-TX. |

NOTE

LIL: Communication is not performed while this LED is not lit. A probable reason for this is that the board is not properly connected to the hub, or that the hub is off. This LED should be lit at all times while the board is properly connected to the hub.

COL: This LED lights frequently if there is excessive traffic on the communication line or if there is excessive peripheral electrical noise.

Fast Ethernet board B

- Specifications

| Item | Code |
|---------------------|----------------|
| Fast Ethernet board | A20B-8100-0670 |

- Mounting positions of connectors, LEDs, etc.

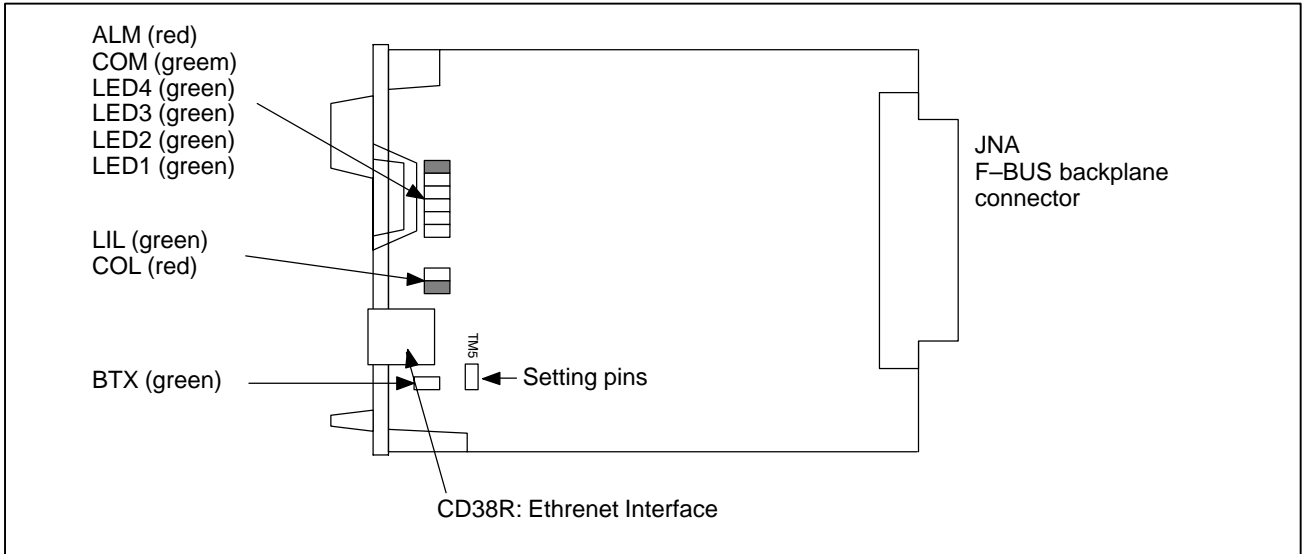

- LED lighting sequence at power on

□: Off ■: On ☆: Blinking ◇: Don't care

| No. | LED indication | Fast Ethernet board status |
|-----|----------------|------------------------------|
| 1 | STATUS □□□□ | Power off |
| 2 | STATUS ■■■■ | Initial state after power on |
| 3 | STATUS ■■■□ | MPU initialized. |
| 4 | STATUS ■■□□ | Firmware downloaded. |
| 5 | STATUS ■□□□ | Control migration to OS |
| 6 | STATUS □■■■ | OS PHASE1 |
| 7 | STATUS □■■□ | OS PHASE2 |
| 8 | STATUS □■□■ | OS PHASE3 |
| 9 | STATUS □■□□ | OS PHASE4 |
| 10 | STATUS □□□☆ | Startup completed. |

The system enters No.10 status when the Fast Ethernet board starts up normally. This status is maintained until an error occurs.

- STATUS LED indications if an error occurs
 If an error occurs, the STATUS LEDs repeatedly flash “LONG” then “SHORT.” (For “LONG,” the LED lights for a long time. For “SHORT,” the LED lights for a short time.)

| No. | STATUS LED indication | | Board state | |
|-----|-----------------------|---------------|----------------------------------|-----------------------------|
| | LONG 4321 | SHORT 4321 | | |
| 1 | ■ ■ □ □ | □ □ ■ ■ | Failure caused by this board. | SRAM parity alarm |
| 2 | ■ □ ■ □ | □ □ □ □ | | General invalid instruction |
| 3 | ■ □ ■ □ | □ □ □ ■ | | Invalid slot instruction |
| 4 | ■ ■ □ □ | □ □ □ ■ | Failure caused by another board. | NMI of another module |

NOTE
 If an error, indicated by repeatedly flashing a LONG and SHORT combination other than the above, occurs, contact FANUC.

- ALARM LED indications if an error occurs

| No. | LED indication | Board state |
|-----|--------------------------|----------------------------------|
| 1 | ALM ■ | Parity error occurred in memory. |

- LED indications related to communication status

| No. | LED indication | Board state |
|-----|---------------------------|---|
| 1 | COM ■ | Lights when data is received or sent. |
| 3 | LIL ■ | Lights when the board is successfully connected to the hub. |
| 4 | COL ■ | Lights if a data collision occurs. |
| 5 | BTX ■ | Lights when a connection is made with 100BASE-TX. |

NOTE
 LIL: Communication is not performed while this LED is not lit. A probable reason for this is that the board is not properly connected to the hub, or that the hub is off. This LED should be lit at all times while the board is properly connected to the hub.
 COL: This LED lights frequently if there is excessive traffic on the communication line or if there is excessive peripheral electrical noise.

- **Setting pins**

On the board, the setting pins (T4, TM5) are installed. Connect jumper plugs to side A (factory-set state). Do not remove a jumper plug, and do not change the setting of a jumper plug. Otherwise, the board does not operate normally.

2.4.4 Fast Data Server Board

For the Series 0i-C, two types of basic unit are available. The usable board differs depending on the basic unit. In this manual, boards are classified as “Fast Data Server board A” and “Fast Data Server board B” for the sake of convenience.

| Drawing number of the basic unit | Fast Data Server board |
|----------------------------------|--------------------------|
| A02B-0309-B50n(n=0,1,...,9) | Fast Data Server board A |
| A02B-0309-B52n(n=0,1,...,9) | Fast Data Server board B |

Fast Data Server board A

- Specification

| Name | Specification |
|---|----------------|
| Fast data server board (ATA card version) | A20B-8100-0770 |
| Add-on board | A20B-2002-0960 |

NOTE

The data server board (ATA card version) cannot fit into any of the following slots.

- Option slot nearest to the LCD

- Connector mounting location

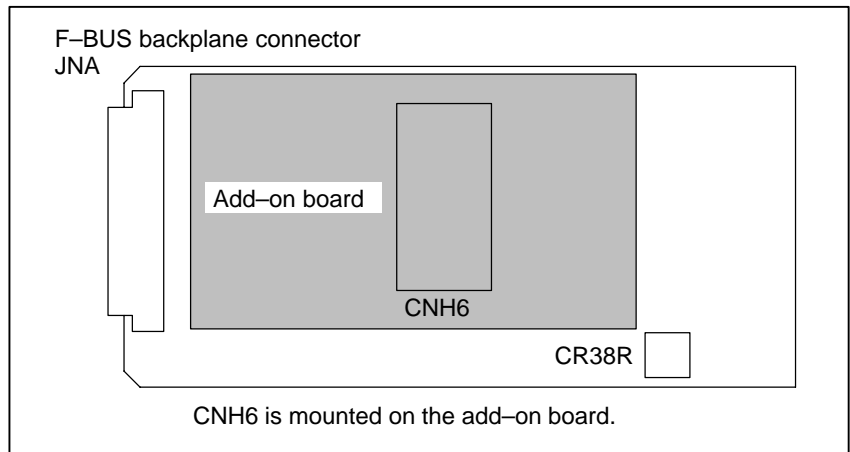

| Connector number | Application |
|------------------|-------------------------------|
| CNH6 | ATA card interface |
| CD38R | 100BASE-TX Ethernet interface |

● LED indication

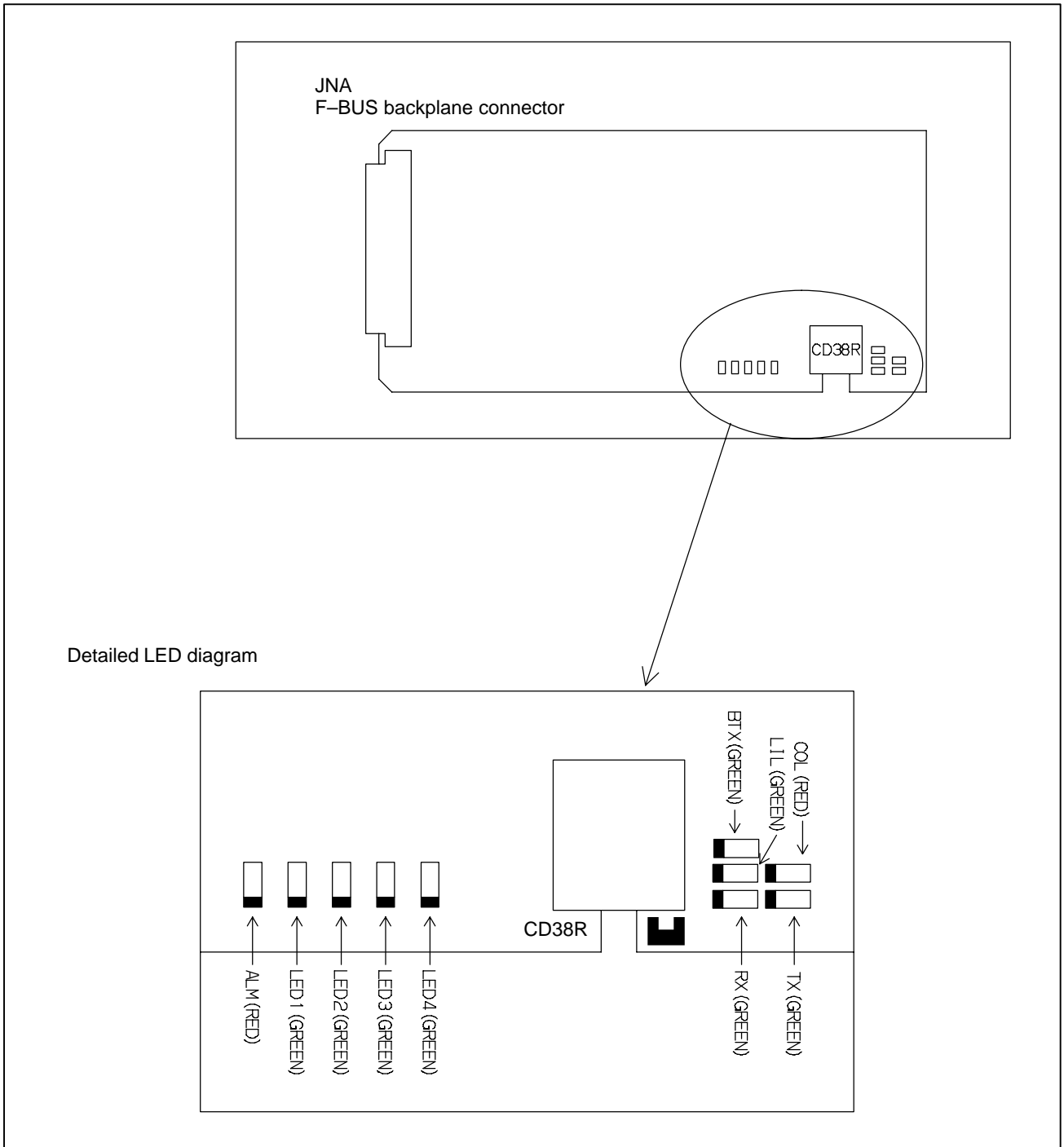

LED indication transition at power-on time

| No. | LED indication 1234 | Board status |
|-----|------------------------|--|
| 1 | STATUS □□□□ | Power off. |
| 2 | STATUS ■■■■ | Initial status immediately after power is switched on. |
| 3 | STATUS □■■■ | MPU initialization completed. |
| 4 | STATUS □□■■ | Firmware download completed. |
| 5 | STATUS □□□■ | Control passed to the OS. |
| 6 | STATUS ■■■□ | OS PHASE 1 |
| 7 | STATUS □■■□ | OS PHASE 2 |
| 8 | STATUS ■□■□ | OS PHASE 3 |
| 9 | STATUS □□■□ | OS PHASE 4 |
| 10 | STATUS ☆□□□ | Start sequence completed. |

When the Data Server board is started normally, the STATUS LEDs light as shown at No. 10. This condition is preserved unless an abnormal condition occurs.

- STATUS LED indications if an error occurs
 If an error occurs, the STATUS LEDs repeatedly flash “LONG” then “SHORT.” (For “LONG,” the LED lights for a long time. For “SHORT,” the LED lights for a short time.)

| No. | STATUS LED indication | | Board state | |
|-----|-----------------------|---------------|----------------------------------|-----------------------------|
| | LONG 1234 | SHORT 4321 | | |
| 1 | □□■ | ■□□ | Failure caused by this board. | SRAM parity alarm |
| 2 | □■□ | □□□□ | | General invalid instruction |
| 3 | □■□■ | ■□□□ | | Invalid slot instruction |
| 4 | □□■ | ■□□□ | Failure caused by another board. | NMI of another module |

NOTE
 If an error, indicated by repeatedly flashing a LONG and SHORT combination other than the above, occurs, contact FANUC.

- ALARM LED indications if an error occurs

| No. | LED indication | Board state |
|-----|----------------|----------------------------------|
| 1 | ALM ■ | Parity error occurred in memory. |

- LED indications related to communication status

| No. | LED indication | Board state |
|-----|----------------|---|
| 1 | TX/RX ■ | Lights when data is received or sent. |
| 3 | LIL ■ | Lights when the board is successfully connected to the hub. |
| 4 | COL ■ | Lights if a data collision occurs. |
| 5 | BTX ■ | Lights when a connection is made with 100BASE-TX. |

NOTE

LIL: Communication is not performed while this LED is not lit. A probable reason for this is that the board is not properly connected to the hub, or that the hub is off. This LED should be lit at all times while the board is properly connected to the hub.

COL: This LED lights frequently if there is excessive traffic on the communication line or if there is excessive peripheral electrical noise.

Fast Data Server board B

- Specifications

| Item | Code |
|------------------------|----------------|
| Fast Data Server board | A20B-8101-0450 |

- Mounting positions of connectors, LEDs, etc.

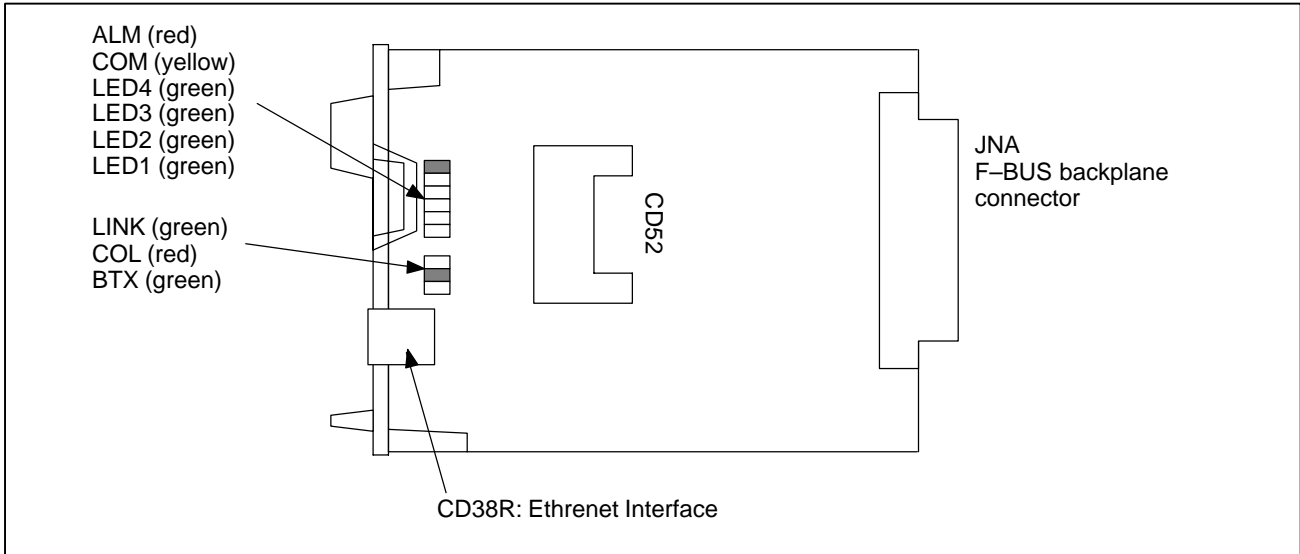

- LED lighting sequence at power on

□: Off ■: On ☆: Blinking ◇: Don't care

| No. | LED indication | Board status |
|-----|----------------|------------------------------|
| 1 | STATUS □□□□ | Power off |
| 2 | STATUS ■■■■ | Initial state after power on |
| 3 | STATUS ■■■□ | MPU initialized. |
| 4 | STATUS ■■□□ | Firmware downloaded. |
| 5 | STATUS ■□□□ | Control migration to OS |
| 6 | STATUS □■■■ | OS PHASE1 |
| 7 | STATUS □■■□ | OS PHASE2 |
| 8 | STATUS □■□■ | OS PHASE3 |
| 9 | STATUS □■□□ | OS PHASE4 |
| 10 | STATUS □□□☆ | Startup completed. |

The system enters No.10 status when the Fast Data Server board starts up normally. This status is maintained until an error occurs.

- STATUS LED indications if an error occurs

If an error occurs, the LEDs repeatedly flash “LONG” then “SHORT.” (For “LONG,” the LED lights for a long time. For “SHORT,” the LED lights for a short time.)

| No. | STATUS LED indication | | Board state | |
|-----|-----------------------|---------------|---------------------------------|-----------------------------|
| | LONG 4321 | SHORT 4321 | | |
| 1 | ■ ■ □ □ | □ □ ■ ■ | Failure caused by this board | SRAM parity alarm |
| 2 | ■ □ ■ □ | □ □ □ □ | | General invalid instruction |
| 3 | ■ □ ■ □ | □ □ □ ■ | | Invalid slot instruction |
| 4 | ■ ■ □ □ | □ □ □ ■ | Failure caused by another board | NMI of another module |

NOTE

If an error, indicated by repeatedly flashing a LONG and SHORT combination other than the above, occurs, contact FANUC.

- ALARM LED indications if an error occurs

| No. | LED indication | Board status |
|-----|------------------|---------------------------------------|
| 1 | ALM ■ | Parity error occurred in main memory. |

- LED indications related to communication status

| No. | LED indication | Fast Ethernet communication status |
|-----|------------------|--|
| 1 | COM ■ | Lights when data is sent. |
| 3 | LINK ■ | Lights when a connection is made correctly with the hub. |
| 4 | COL ■ | Lights if a data collision occurs. |
| 5 | BTX ■ | Lights when a connection is made with 100BASE-TX. |

NOTE

LINK: Communication is not performed while this LED is not lit. A probable reason for this is that the Fast data server is not properly connected to the hub, or that the hub is off. This LED should be lit at all times while the Fast Data Server is properly connected to the hub.

COL: This LED lights frequently if there is excessive traffic on the communication line or if there is excessive peripheral electrical noise.

2.4.5 PROFIBUS-DP Board

For the Series 0i-C, two types of basic unit are available. The usable board differs depending on the basic unit. In this manual, boards are classified as “PROFIBUS-DP board A” and “PROFIBUS-DP board B” for the sake of convenience.

| Drawing number of the basic unit | PROFIBUS-DP board |
|----------------------------------|---------------------|
| A02B-0309-B50n(n=0,1,...,9) | PROFIBUS-DP board A |
| A02B-0309-B52n(n=0,1,...,9) | PROFIBUS-DP board B |

PROFIBUS-DP board B is available in two types, one for a master and one for a slave.

PROFIBUS-DP board A can be used with either a master or a slave.

PROFIBUS-DP board A

| Name | Specification |
|-------------------------------------|----------------|
| PROFIBUS-DP board (master function) | A20B-8100-0430 |
| Add-on board (slave function) | A20B-2100-0430 |

• Connector location

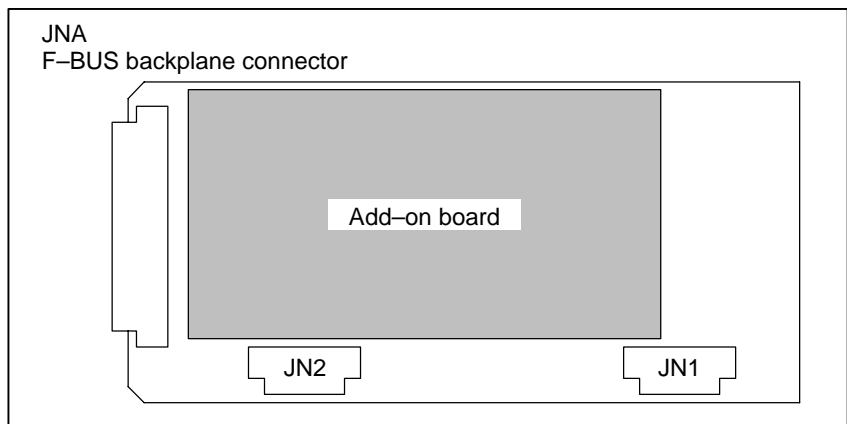

| Connector number | Application |
|------------------|---|
| JN1 | Adapter unit interface for master station |
| JN2 | Adapter unit interface for slave station |

• Card location

No card is mounted on the PROFIBUS-DP board.

● LED indication

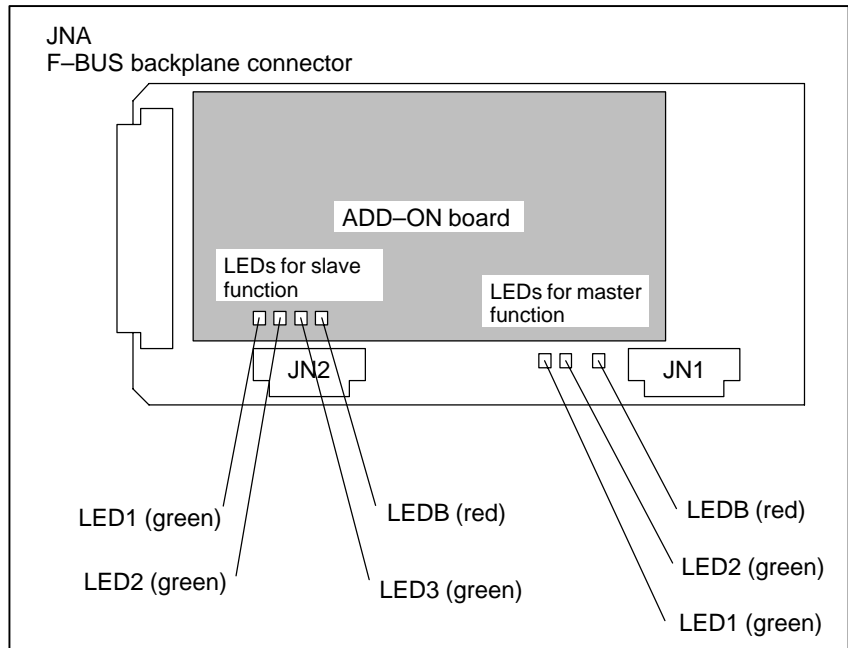

(1) LEDs for master function

| LED No. (abbreviation) | Meaning |
|------------------------|--|
| LED1 (CPU) | Lights to indicate the CPU for the master function is running. |
| LED2 (TOKEN) | Lights when the communication LSI (ASPC2) has a token (right to transmit). |
| LEDB (PALM) | Lights when a memory parity alarm occurs in the master function circuit. It is likely that the hardware is defective. |

(2) LEDs for slave function (mounted on the add-on board)

| LED No. (abbreviation) | Meaning |
|------------------------|---|
| LED1 (CPU) | Lights to indicate the CPU for the slave function is running. |
| LED2 (COMM) | Lights when PROFIBUS communication starts. It remains to be on after the PROFIBUS communication is suspended, however. |
| LED3 (RUN) | Lights to indicate that PROFIBUS communication is being performed normally. |
| LEDB (PALM) | Lights when a memory parity alarm occurs in the slave function circuit. It is likely that the hardware is defective. |

PROFIBUS-DP board B (Master)

- Specifications

| Item | Code |
|-----------------------|----------------|
| PROFIBUS master board | A20B-8100-0470 |

- Mounting positions of connectors, LEDs, etc.

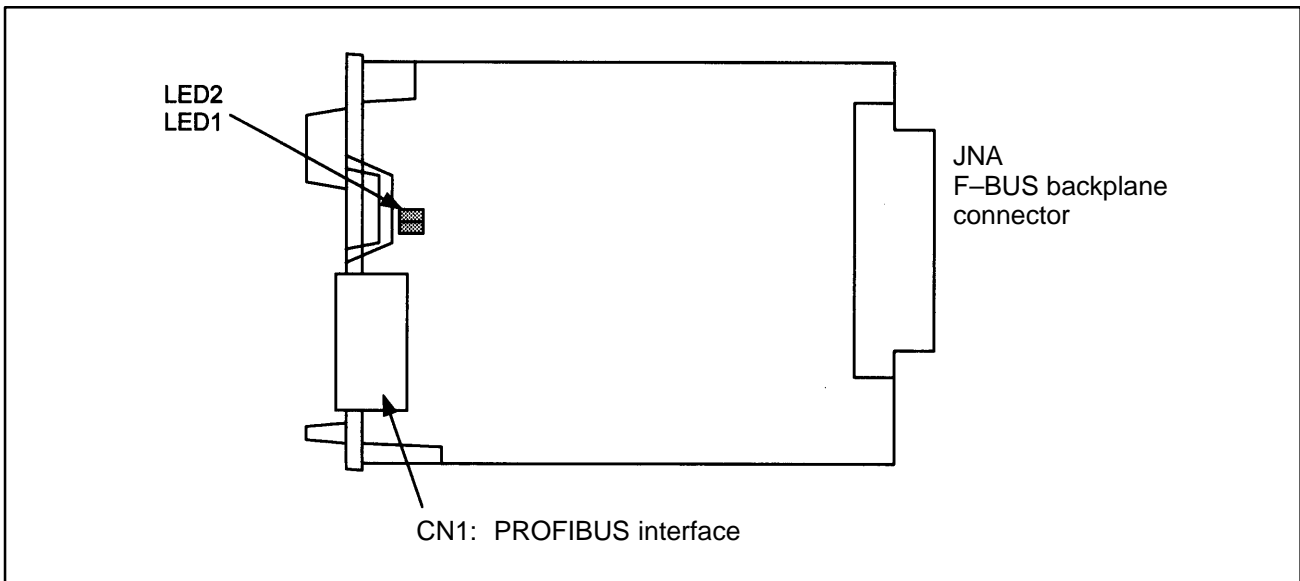

- LED display

| Name | Color | DescriptionState |
|------|-------|--|
| LED1 | Green | Indicates whether the CPU of this board has been activated. Lit if the CPU has been released from the reset state and activated. The LED does not go on when the power is turned on. |
| LED2 | Green | Indicates whether normal communication is performed. Lit if normal communication is performed. Not lit if communication is not performed. The LED does not go on when the power is turned on. |

PROFIBUS-DP board B (Slave)

- Specifications

| Item | Code |
|----------------------|----------------|
| PROFIBUS slave board | A20B-8100-0440 |

- Mounting positions of connectors, LEDs, etc.

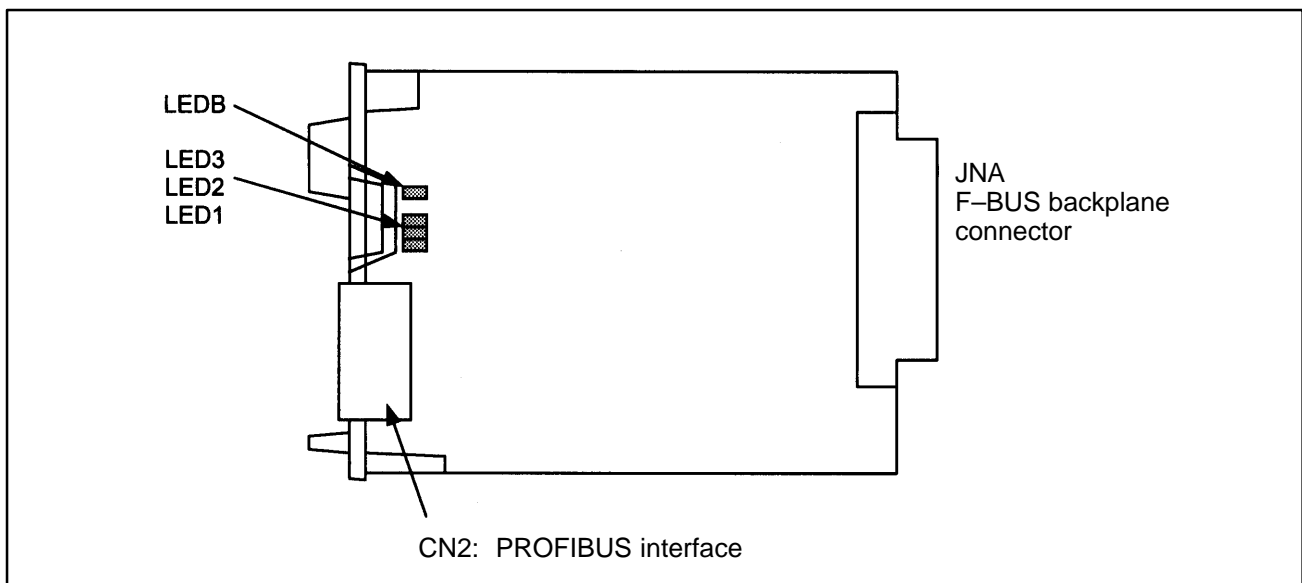

- LED display

| Name | Color | Description |
|------|-------|---|
| LED1 | Green | Indicates whether the CPU of this board has been released from the reset state and activated. Lit if the CPU has been released from the reset state and activated. The LED does not go on immediately after power-up. |
| LED2 | Green | Indicates whether communication has started. Lit if communication has started. The LED is not lit when the power is turned on and in the following cases: 1) When parameter configuration data has not been received 2) When illegal parameter configuration data has been received |
| LED3 | Green | Indicates whether the current communication is normally performed. Lit if the current communication is normally performed. Not lit if the current communication is not normally performed. The LED does not go on when the power is turned on. |
| LEDB | Red | Indicates if a RAM parity error has occurred on this board. Lit if a RAM parity error has occurred. The LED does not go on when the power is turned on. Once lit, the LED continues illuminating until the power is turned off. |

- STATUS LED indications if an error occurs
 If an error occurs, the STATUS LEDs repeatedly flash “LONG” then “SHORT.” (For “LONG,” the LED lights for a long time. For “SHORT,” the LED lights for a short time.)

| No. | STATUS LED indication | | Board state | |
|-----|-----------------------|---------------|----------------------------------|-----------------------------|
| | LONG 4321 | SHORT 4321 | | |
| 1 | ■ ■ □ □ | □ □ ■ ■ | Failure caused by this board. | SRAM parity alarm |
| 2 | ■ □ ■ □ | □ □ □ □ | | General invalid instruction |
| 3 | ■ □ ■ □ | □ □ □ ■ | | Invalid slot instruction |
| 4 | ■ ■ □ □ | □ □ □ ■ | Failure caused by another board. | NMI of another module |

NOTE
 If an error, indicated by repeatedly flashing a LONG and SHORT combination other than the above, occurs, contact FANUC.

- ALARM LED indications if an error occurs

| No. | LED indication | Board state |
|-----|--------------------------|----------------------------------|
| 1 | ALM ■ | Parity error occurred in memory. |

- LED indications related to communication status

| No. | LED indication | Board state |
|-----|---------------------------|---|
| 1 | COM ■ | Lights when data is received or sent. |
| 3 | LIL ■ | Lights when the board is successfully connected to the hub. |
| 4 | COL ■ | Lights if a data collision occurs. |
| 5 | BTX ■ | Lights when a connection is made with 100BASE-TX. |

NOTE
 LIL: Communication is not performed while this LED is not lit. A probable reason for this is that the board is not properly connected to the hub, or that the hub is off. This LED should be lit at all times while the board is properly connected to the hub.
 COL: This LED lights frequently if there is excessive traffic on the communication line or if there is excessive peripheral electrical noise.

- **Setting pins**

On the board, the setting pins (T4, TM5) are installed. Connect jumper plugs to side A (factory-set state). Do not remove a jumper plug, and do not change the setting of a jumper plug. Otherwise, the board does not operate normally.

2.4.6 I/O Board for 0i

- Specifications

| Name | Code |
|-----------------|------------------------------------|
| I/O unit for 0i | A02B-0309-C001 (A16B-2203-0881) |

- Mounting positions of connectors, LEDs, etc.

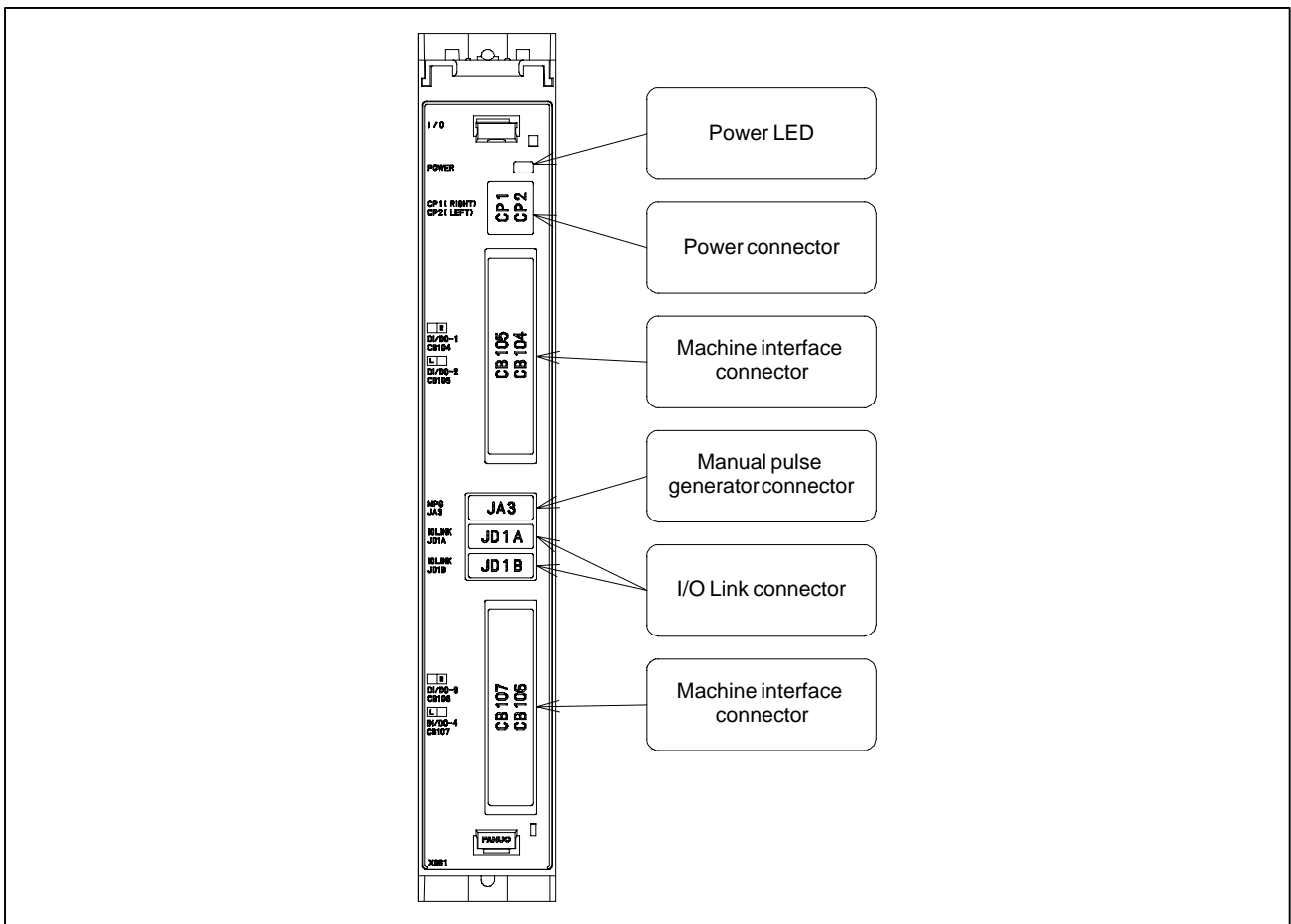

2.5 UNITS AND PRINTED CIRCUIT BOARDS

2.5.1 Basic Units

For the Series *0i-C/0i Mate-C*, two types of basic unit are available.

| Model | Item | Drawing No. | | Remarks |
|------------------|-------------------------|----------------------------------|----------------------------------|---------|
| <i>0i-C</i> | Basic unit without slot | A02B-0309-B500 | A02B-0309-B520 | |
| | Basic unit with 2 slots | A02B-0309-B502 | A02B-0309-B522 | |
| <i>0i Mate-C</i> | Basic unit without slot | A02B-0311-B500 A02B-0311-B510 | A02B-0311-B520 A02B-0311-B530 | |

Cover Case

| Model | Item | Drawing No. | | Remarks |
|-------------|-------------------------|---|---|---------|
| | | A02B-0309-B50n A02B-0311-B50n A02B-0311-B51n (n=0,1,...,9) | A02B-0309-B52n A02B-0311-B52n A02B-0311-B53n (n=0,1,...,9) | |
| Common | Cover case without slot | A02B-0236-D100#0C | A250-0905-X001 | |
| <i>0i-C</i> | Cover case with 2 slots | A02B-0236-D100#2C | A250-0905-X002 | |

2.5.2 LCD/MDI Units

| Model | Item | Drawing No. | | Remarks |
|-------------|--------------------------------------|---|---|--------------------------|
| | | A02B-0309-B50n A02B-0311-B50n A02B-0311-B51n (n=0,1,...,9) | A02B-0309-B52n A02B-0311-B52n A02B-0311-B53n (n=0,1,...,9) | |
| <i>0i-C</i> | 10.4" LCD unit | A02B-0309-D500 | A02B-0309-D510 | |
| Common | 7.2" LCD/MDI unit | A02B-0309-D502#T | A02B-0309-D512#T | Horizontal type T series |
| | | A02B-0309-D502#M | A02B-0309-D512#M | Horizontal type M series |
| | | A02B-0309-D503#T | A02B-0309-D513#T | Vertical type T series |
| | | A02B-0309-D503#M | A02B-0309-D513#M | Vertical type M series |
| | 8.4" LCD/MDI unit | A02B-0309-D504#T | A02B-0309-D514#T | Horizontal type T series |
| | | A02B-0309-D504#M | A02B-0309-D514#M | Horizontal type M series |
| | | A02B-0309-D505#T | A02B-0309-D515#T | Vertical type T series |
| | | A02B-0309-D505#M | A02B-0309-D515#M | Vertical type M series |
| | 7.2" LCD/MDI unit with a touch panel | A02B-0309-D506#T | A02B-0309-D516#T | Horizontal type T series |
| | | A02B-0309-D507#T | A02B-0309-D517#T | Vertical type T series |
| | 8.4" LCD/MDI unit with a touch panel | A02B-0309-D508#T | A02B-0309-D518#T | Horizontal type T series |
| | | A02B-0309-D509#T | A02B-0309-D519#T | Vertical type T series |
| <i>0i-C</i> | MDI unit (for 10.4" LCD unit) | A02B-0281-C125#TBE | | Horizontal type T series |
| | | A02B-0281-C125#MBE | | Horizontal type M series |
| | | A02B-0281-C126#TBE | | Vertical type T series |
| | | A02B-0281-C126#MBE | | Vertical type M series |

2.5.3 Printed Circuit Boards

(If the drawing number of the basic unit is A02B-0309-B50n,
A02B-0311-B50n, or A02B-0311-B51n (where n is 0, 1, ..., 9))

| Item | Drawing No. | ID | Remarks |
|---|----------------|----------------------|---------|
| 0i-C main board (PMC-SA1) | A20B-8101-0280 | 0x18 | |
| 0i-C main board (PMC-SB7) | A20B-8101-0281 | 1x18 | |
| 0i Mate-C main board | A20B-8101-0285 | 0x19 | |
| Power supply unit | A20B-8101-0180 | - | |
| CPU card (486 with 16 MB of DRAM) | A20B-3300-0291 | CPU: 09 DRAM: 89 | |
| CPU card (486 with 32 MB of DRAM) | A20B-3300-0290 | CPU: 09 DRAM: 8A | |
| CPU card (Pentium with 32 MB of DRAM) | A20B-3300-0313 | CPU: 11 DRAM: AA | |
| 2-axis control card (C5410) | A20B-3300-0393 | 08 02 0x | |
| 4-axis control card (C5410) | A20B-3300-0392 | 08 02 1x | |
| Display control card B (for 8.4" color graphics) | A20B-3300-0281 | 0A | |
| Display control card D (for 7.2" color graphics) | A20B-3300-0283 | 02 | |
| Display control card (for 10.4" color graphics) | A20B-3300-0280 | 0E | |
| FROM/SRAM memory H (32M/1M) | A20B-3900-0163 | FROM: C2 SRAM: 03 | |
| Analog spindle module | A20B-3900-0170 | - | |
| Fast Ethernet board (100BASE-TX connector) | A20B-8100-0770 | x08E | |
| Fast data server board (for ATA flash memory card) (100BASE-TX connector) | A20B-8100-0770 | x08E | |
| Add-on board for fast Ethernet board | A20B-2002-0960 | - | |
| PROFIBUS (master/slave) board | A20B-8100-0430 | 0xBB | |
| Add-on board for PROFIBUS board | A20B-2100-0430 | - | |
| Back-panel with 2 slots | A20B-2003-0150 | - | |
| Inverter (for 8.4" color LCD) | A20B-8001-0922 | - | |
| Inverter (for 7.2" monochrome LCD) | A20B-8100-0710 | - | |
| Inverter (for 10.4" color LCD) | A20B-8001-0920 | - | |

(If the drawing number of the basic unit is A02B-0309-B52n,
A02B-0311-B52n, or A02B-0311-B53n (where n is 0, 1, ..., 9))

| Item | Drawing No. | ID | Remarks |
|---|------------------|-----------------------------------|-------------------------|
| Series 0i-C main board (PMC-SB7 CPU: Pentium DRAM: 32MB) | A20B-8200-0381 | MAIN: 1x1A CPU: 11 DRAM: AA | |
| Series 0i-C main board (PMC-SB7 CPU: 486 DRAM: 32MB) | A20B-8200-0391 | MAIN: 1x1B CPU: 09 DRAM: 8A | |
| Series 0i-C main board (PMC-SA1 CPU: 486 DRAM: 32MB) | A20B-8200-0390 | MAIN: 0x1B CPU: 09 DRAM: 8A | |
| Series 0i Mate-C main board (PMC-SA1 CPU: 486 DRAM: 16MB) | A20B-8200-0395 | MAIN: 0x1C CPU: 09 DRAM: 89 | |
| Axis/display card | A20B-8200-0360 | SERVO: 08 02 1x | 4-axis control |
| | A20B-8200-0361 | SERVO: 08 02 0x | 2-axis control |
| Power supply card | A20B-8101-0430 | - | |
| | A20B-8101-0440 | - | |
| FROM/SRAM module | A20B-3900-0163 | FROM: C2 SRAM: 03 | |
| Inverter | A20B-8002-0631 | DISPLAY: 02 | For 7.2" monochrome LCD |
| | A20B-8002-0632 | DISPLAY: 0E | For 10.4" color LCD |
| | A20B-8002-0633 | DISPLAY: 0A | For 8.4" color LCD |
| Touch panel interface board | A20B-8002-0312 | - | |
| Fast Ethernet board | A20B-8100-0670 | x08E | |
| Fast data server board | To be determined | | |
| PROFIBUS board (master) | A20B-8100-0470 | xxFC | |
| PROFIBUS board (slave) | A20B-8100-0440 | xxE3 | |

2.5.4 I/O

| Item | Drawing No. | Remarks |
|---|------------------|-----------------------|
| I/O unit for the 0i | A02B-0309-C001 | |
| Distributed I/O operator's panel I/O module A1 | A20B-2002-0470 | |
| Distributed I/O operator's panel I/O module B1 | A20B-2002-0520 | |
| Distributed I/O operator's panel I/O module B2 | A20B-2002-0521 | |
| Distributed I/O connector panel basic I/O module | A03B-0815-C001 | |
| Distributed I/O connector panel expansion I/O module A | A03B-0815-C002 | |
| Distributed I/O connector panel expansion I/O module B | A03B-0815-C003 | |
| Distributed I/O connector panel expansion I/O module C | A03B-0815-C004 | |
| Distributed I/O connector panel expansion I/O module D | A03B-0815-C005 | |
| Machine operator's panel main panel B (symbol keys) | A02B-0236-C231 | |
| Machine operator's panel main panel B1 (alphabet keys) | A02B-0236-C241 | |
| Machine operator's panel sub-panel A | A02B-0236-C232 | |
| Machine operator's panel sub-panel B | A02B-0236-C233 | |
| Machine operator's panel sub-panel B1 | A02B-0236-C235 | |
| Machine operator's panel sub-panel C | A02B-0236-C234 | |
| Machine operator's panel sub-panel C1 | A02B-0236-C236 | |
| Small-size machine operator's panel | A02B-0299-C150#T | |
| Operator's panel connection unit (source type output A) | A16B-2202-0731 | DI/DO: 64/32 |
| Operator's panel connection unit (source type output B) | A16B-2202-0730 | DI/DO: 96/64 |
| I/O link connection unit A | A20B-2000-0410 | Electrical-optical |
| I/O link connection unit B | A20B-2000-0411 | Electrical-electrical |
| I/O link connection unit C | A20B-2000-0412 | Optical-optical |

2.5.5 Other Units

| Item | Drawing No. | Remarks |
|---|----------------|--------------------|
| Separate detector I/F 4-axis basic unit | A02B-0236-C205 | |
| Optical I/O Link adaptor | A13B-0154-B001 | |
| Optical adaptor | A13B-0154-B003 | For SPM connection |

2.6 REPLACING THE MAIN BOARD

WARNING

Only those personnel who have received approved safety and maintenance training may perform this replacement work.

When opening the cabinet and replacing the board, be careful not to touch the high-voltage circuits (marked  and fitted with an insulating cover). Touching the uncovered high-voltage circuits presents an extremely dangerous electric shock hazard.

CAUTION

Before starting replacement work, back up the contents (such as parameters and programs) of the SRAM memory of the CNC. Otherwise, the contents of the SRAM memory may be lost during replacement work.

• Replacement procedure

If the drawing number of the basic unit is A02B-0309-B50n, A02B-0311-B50n, or A02B-0311-B51n (where n is 0, 1, ..., 9)

- 1) Unscrew the four screws fastening the case, and remove the case. The fan and battery cable do not have to be removed.

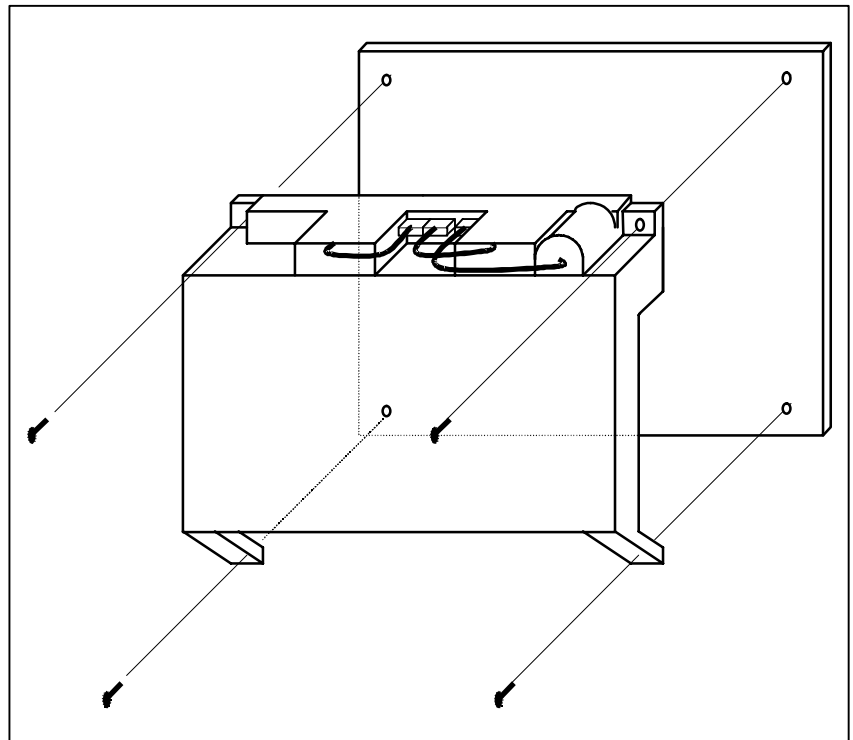

- 2) Remove the cables from connectors CNM1A (PCMCIA interface connector), CN8 (video signal interface connector) and CN2 (soft key connector) on the main board. Then, unscrew the screws fastening the main board. The connector CN3 (inverter connector) directly connects the main board to the inverter PCB. Slide the main board downward when removing the main board.

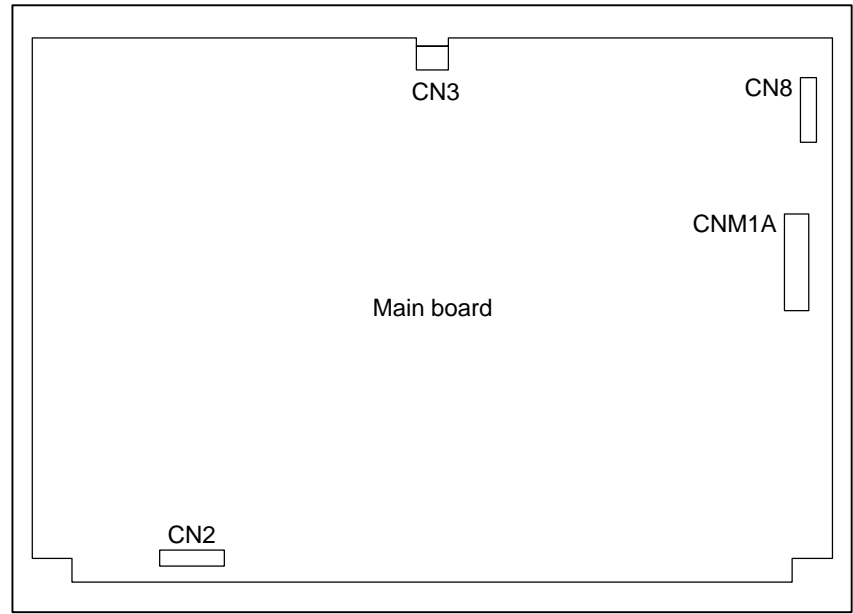

- 3) When mounting the main board, reverse steps 1) and 2).

If the drawing number of the basic unit is A02B-0309-B52n, A02B-0311-B52n, or A02B-0311-B53n (where n is 0, 1, ..., 9)

- 1) Unscrew the two screws fastening the case. (If a cable is connected to the option card, you must first remove the cable before starting the replacement work.)
- 2) Extract the case while releasing both of the claws at the top of the case that are latched to the base plate. You can extract the case with the back panel, fan, and battery mounted.

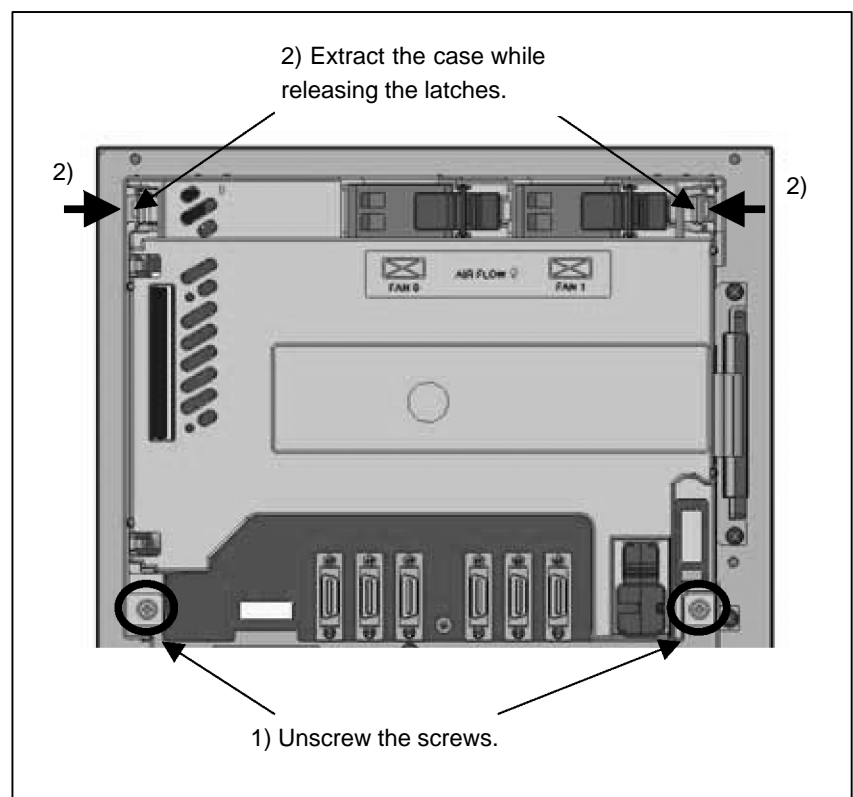

- 3) Remove the cables from connectors CNM1A (PCMCIA interface connector), CN8 (video signal interface connector), and CN2 (soft key connector) on the main board.

Then, unscrew the screws fastening the main board. Connector CA115A directly connects the main board to the inverter PCB. Slide the main board downward when removing the main board.

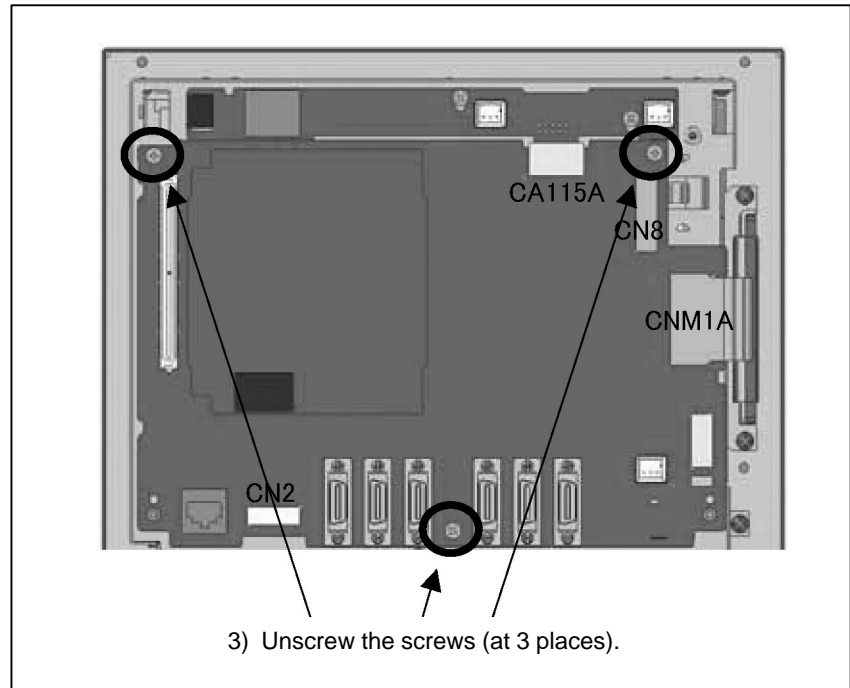

- 4) Replace the main board.
- 5) Slowly insert the cover while arranging the screw holes and latches in the correct positions. When the cover is installed, the power supply PCB on the cover and the main board are connected via their connectors. You should insert the cover using caution to prevent excessive strain on it while checking the connection between the connectors.
- 6) Ensure that the cover latches are engaged securely, and then tighten the cover screws. Push the fan and battery lightly to ensure that their connections are established securely. (If you have removed the cable from the option card, reconnect the cable.)

2.7 MOUNTING AND DEMOUNTING CARD PCBS



WARNING

Only those personnel who have received approved safety and maintenance training may perform this replacement work.

When opening the cabinet and replacing a card PCB, be careful not to touch the high-voltage circuits (marked  and fitted with an insulating cover). Touching the uncovered high-voltage circuits presents an extremely dangerous electric shock hazard.



CAUTION

- 1 Before starting replacement work, back up the contents (such as parameters and programs) of the SRAM memory of the CNC. Otherwise, the contents of the SRAM memory may be lost during replacement work.
- 2 If the SRMA data check method (parity check or ECC check) has been changed after the replacement, a parity or ECC alarm may occur at power-on, possibly causing damage to the SRAM data. Back up the SRAM data before starting replacement, and restore the data after completing the replacement.

2.7.1 Demounting a Card PCB

- 1) Pull outward the claw of each of the four spacers used to secure the card PCB, then release each latch. (See Fig. a.)
- 2) Extract the card PCB upward. (See Fig. b.)

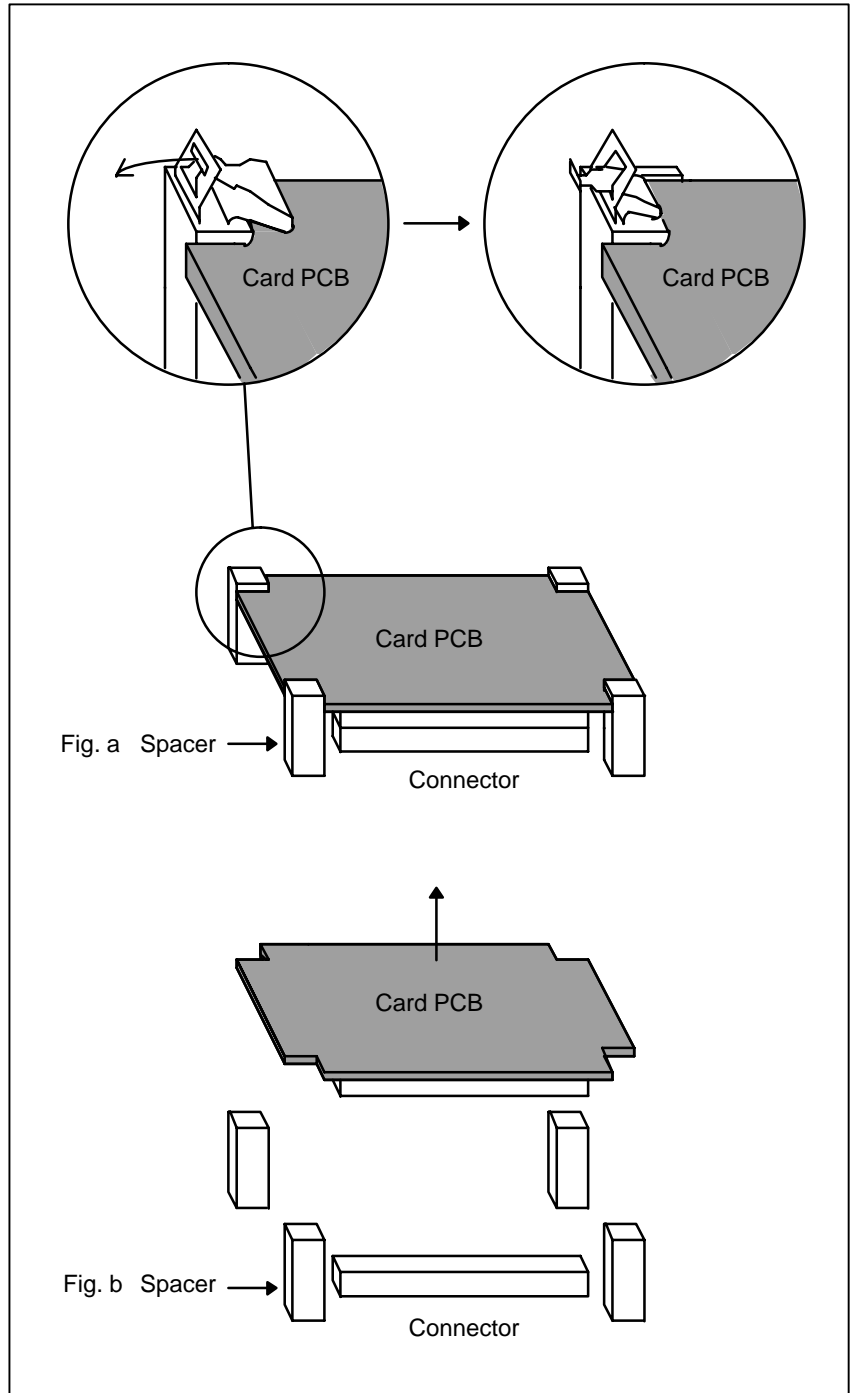

2.7.2 Mounting a Card PCB

- 1) Check that the claw of each of the spacers is latched outward, then insert the card PCB into the connector. (See Fig. c.)
- 2) Push the claw of each spacer downward to secure the card PCB. (See Fig. d.)

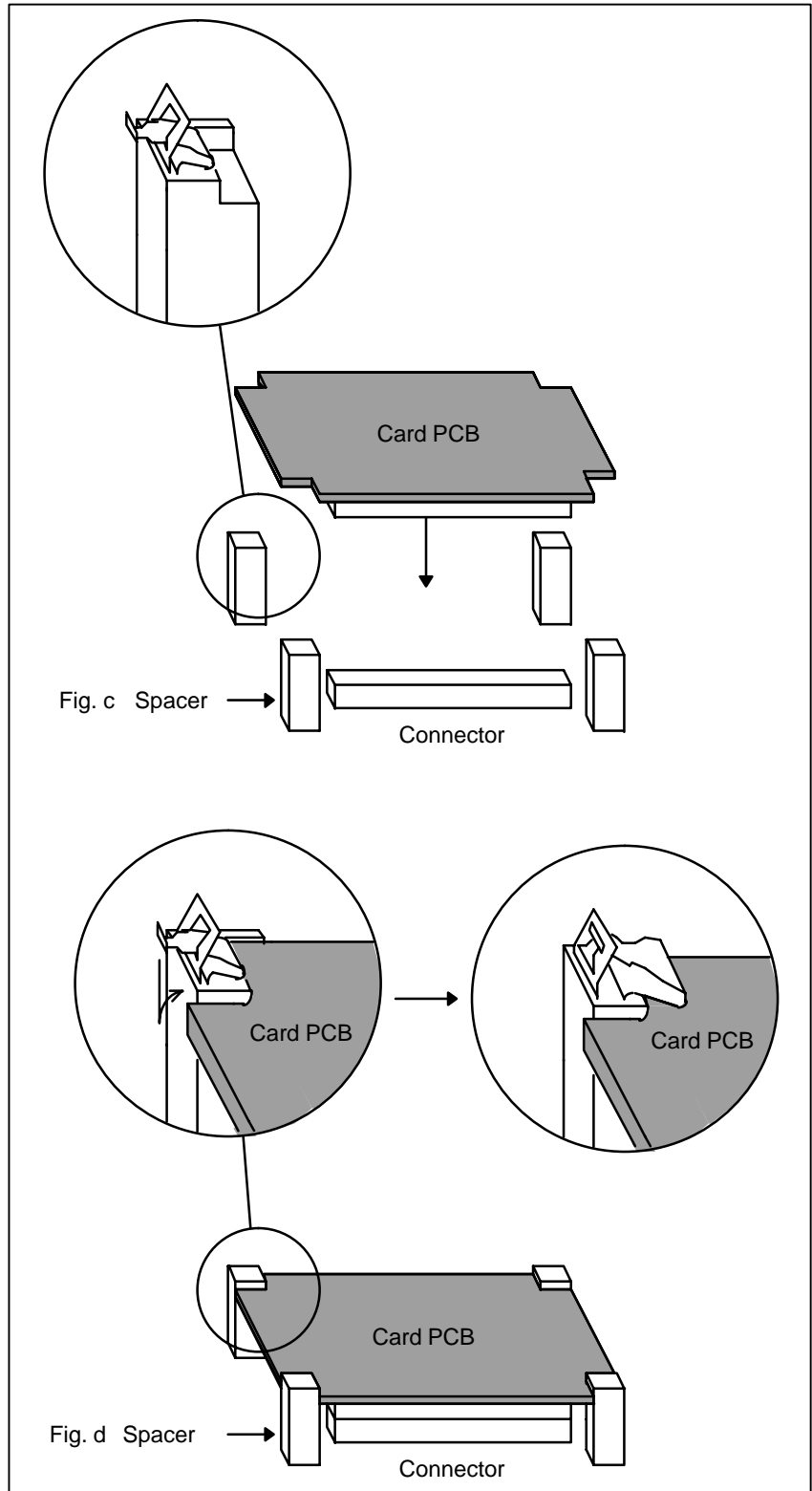

2.8 MOUNTING AND DEMOUNTING DIMM MODULES



WARNING

Only those personnel who have received approved safety and maintenance training may perform this replacement work.

When opening the cabinet and replacing a module, be careful not to touch the high-voltage circuits (marked  and fitted with an insulating cover). Touching the uncovered high-voltage circuits presents an extremely dangerous electric shock hazard.



CAUTION

Before starting replacement work, back up the contents (such as parameters and programs) of the SRAM memory of the CNC. Otherwise, the contents of the SRAM memory may be lost during replacement work.

Before replacing an SRAM module, be sure to back up the contents of the SRAM module.

2.8.1 Demounting a DIMM Module

- 1) Open the claw of the socket outward. (See Fig. a.)
- 2) Extract the module slantly upward. (See Fig. b.)

2.8.2 Mounting a DIMM Module

- 1) Insert the module slantly into the module socket, with side B facing upward. (See Fig. b.)
- 2) Push the module downward until it is locked. (See Fig. c.)
At this time, push it down with pushing two points of (*) in the figure.

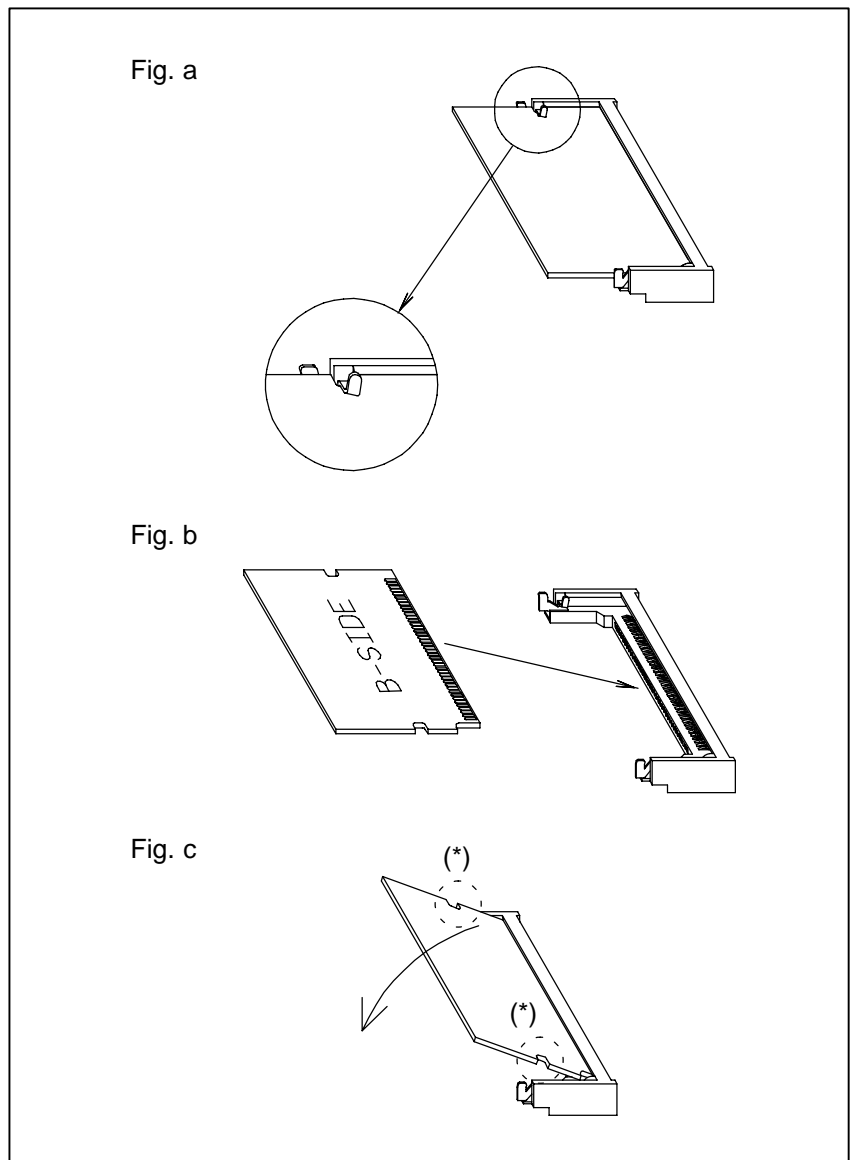

2.9 REPLACING FUSE ON CONTROL UNIT

WARNING

Before replacing a blown fuse, locate and remove the cause of the blown fuse.

For this reason, only those personnel who have received approved safety and maintenance training may perform this replacement work.

When opening the cabinet and replacing a fuse, be careful not to touch the high-voltage circuits (marked  and fitted with an insulating cover). Touching the uncovered high-voltage circuits presents an extremely dangerous electric shock hazard.

● Fuse mounting location

If the drawing number of the basic unit is A02B-0309-B50n, A02B-0311-B50n, or A02B-0311-B51n (where n is 0, 1, ..., 9)

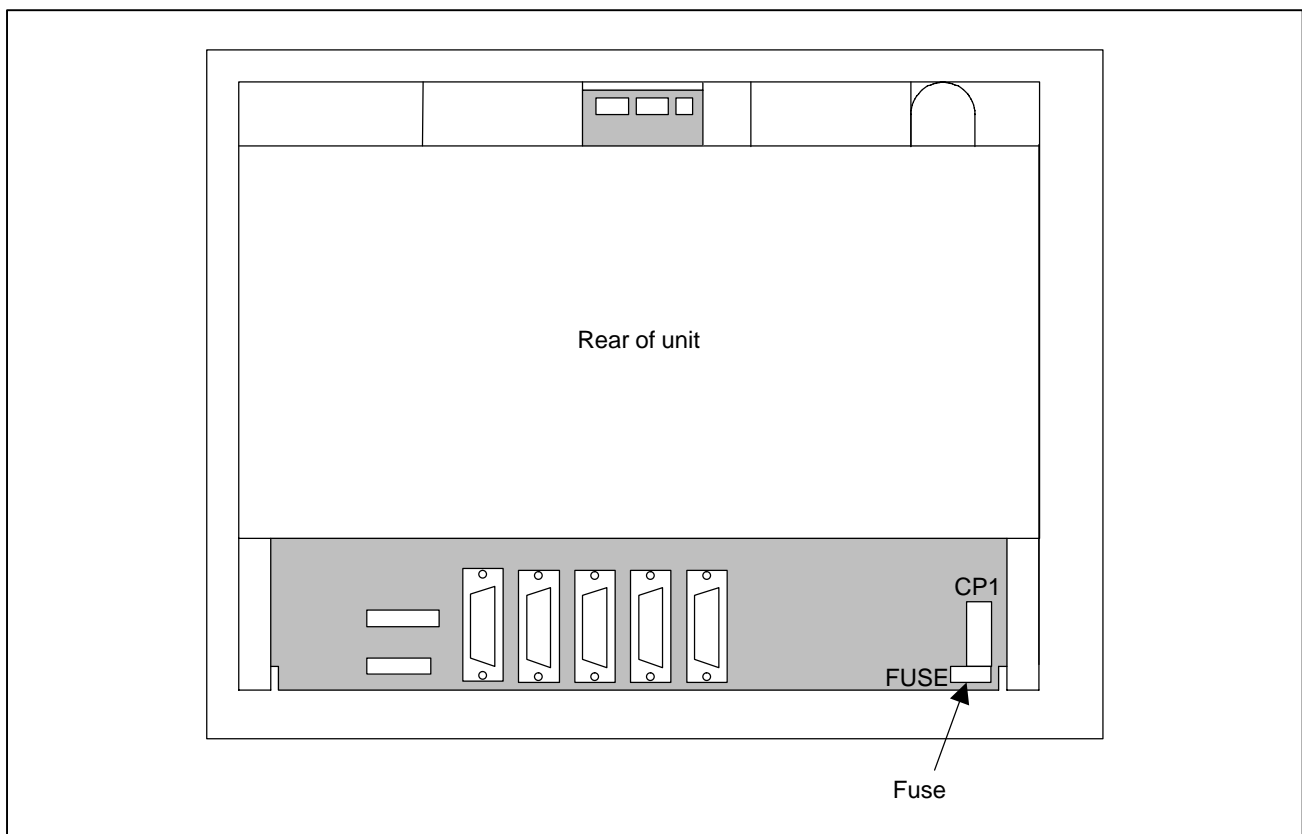

● **Ordering codes of fuses**

If the drawing number of the basic unit is A02B-0309-B50n, A02B-0311-B50n, or A02B-0311-B51n (where n is 0, 1, ..., 9)

| Ordering code | Rating | Parts specification |
|----------------|--------|----------------------|
| A02B-0236-K100 | 5A | A60L-0001-0290#LM50C |

● **Fuse mounting location**

If the drawing number of the basic unit is A02B-0309-B52n, A02B-0311-B52n, or A02B-0311-B53n (where n is 0, 1, ..., 9)

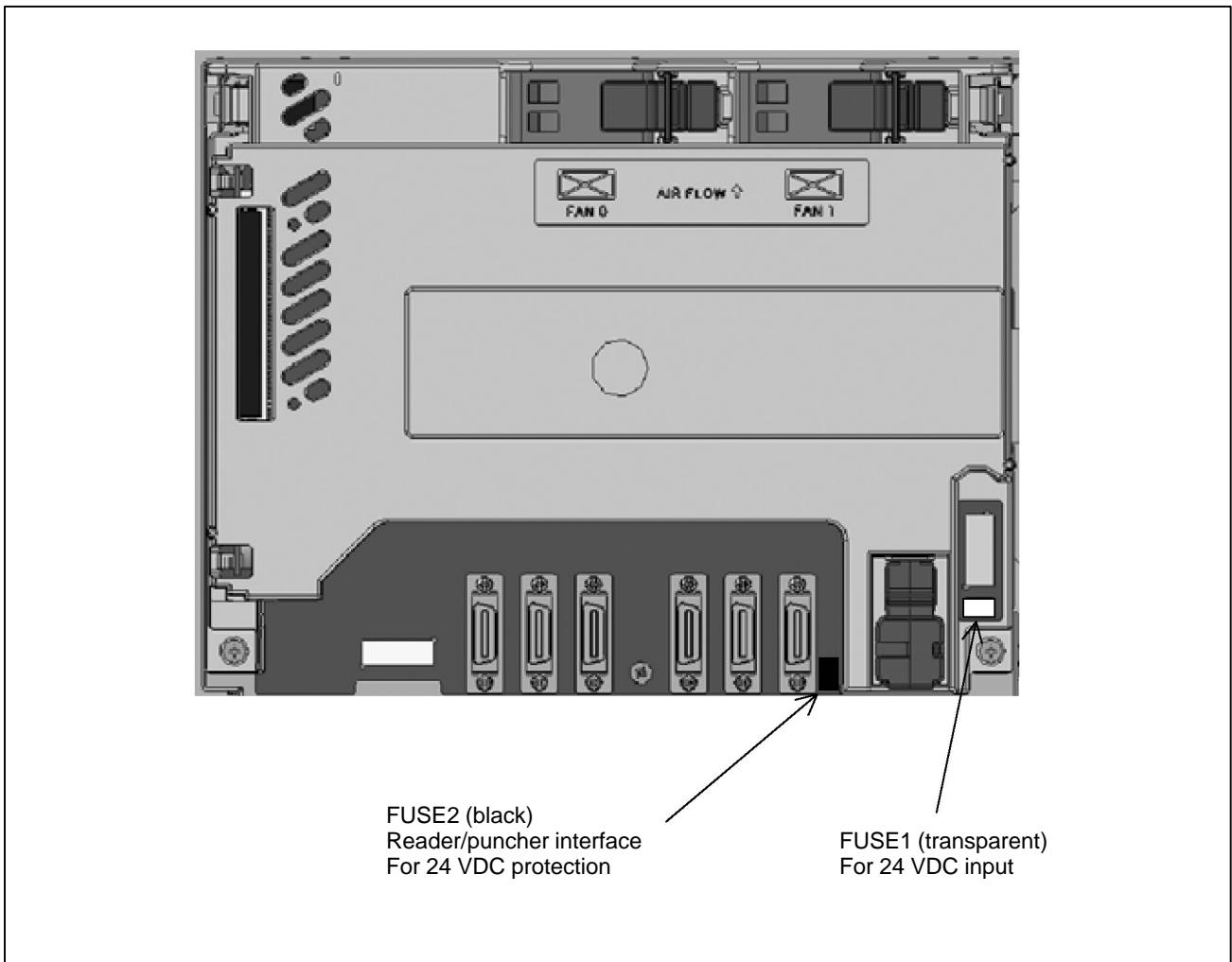

● **Ordering codes of fuses**

If the drawing number of the basic unit is A02B-0309-B52n, A02B-0311-B52n, or A02B-0311-B53n (where n is 0, 1, ..., 9)

| Symbol | Application | Ordering code | Rating | Parts specification |
|--------|--|----------------|--------|----------------------|
| FUSE1 | For 24 VDC input | A02B-0236-K100 | 5A | A60L-0001-0290#LM50C |
| FUSE2 | For 24 VDC output protection in the reader/puncher interface | A02B-0815-K001 | 1A | A60L-0001-0290#LM10 |

2.10 REPLACING BATTERY

Part programs, offset data, and system parameters are stored in CMOS memory in the control unit. The power to the CMOS memory is backed up by a lithium battery mounted on the front panel of the control unit. The above data is not lost even when the main battery goes dead. The backup battery is mounted on the control unit at shipping. This battery can maintain the contents of memory for about a year.

When the voltage of the battery becomes low, alarm message “BAT” blinks on the display and the battery alarm signal is output to the PMC. When this alarm is displayed, replace the battery as soon as possible. In general, the battery can be replaced within two or three weeks, however, this depends on the system configuration.

If the voltage of the battery becomes any lower, memory can no longer be backed up. Turning on the power to the control unit in this state causes system alarm 910 (SRAM parity alarm) or 935 (SRAM ECC error) to occur because the contents of memory are lost. Clear the entire memory and reenter data after replacing the battery.

The following two kinds of batteries can be used.

- Lithium battery built into the CNC control unit.
- Two alkaline dry cells (size D) in the external battery case.

NOTE

A lithium battery is installed as standard at the factory.

- **Replacement procedure
For internal battery
(lithium battery)
(If the drawing number of
the basic unit is
A02B-0309-B50n,
A02B-0311-B50n, or
A02B-0311-B51n
(where n is 0, 1, ..., 9))**

When a lithium battery is used

Prepare a new lithium battery (ordering code: A02B-0200-K102 (FANUC specification: A98L-0031-0012)).

- 1) Turn on the power to the CNC. After about 30 seconds, turn off the power.
- 2) Remove the old battery from the top of the CNC control unit. First, unplug the battery connector, then take the battery out of its case.

The battery case of a control unit without option slots is located at the top end of the unit as shown in the figure of the previous page. The battery case of a control unit with optional slots is located in the central area of the top of the unit (between fans).

- 3) Insert a new battery and reconnect the connector.

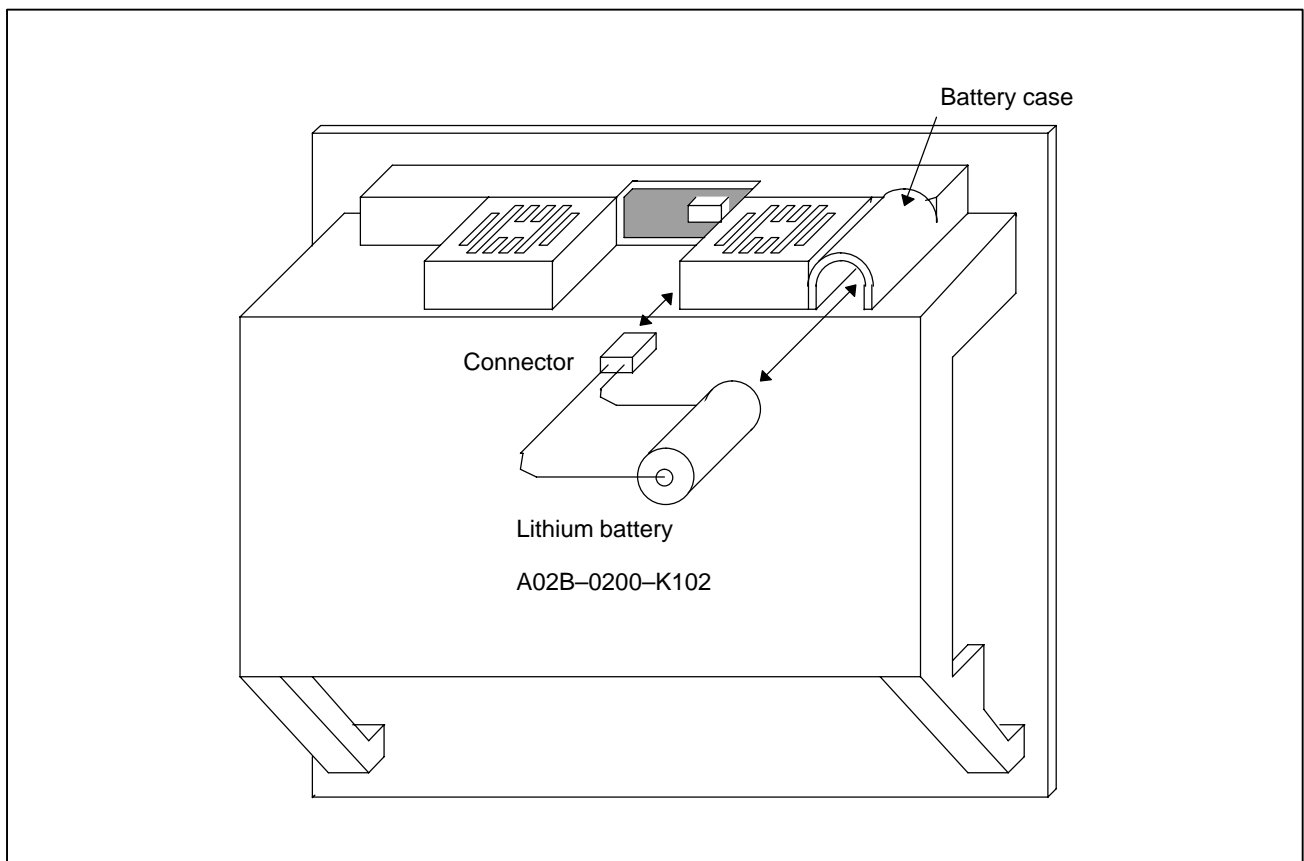

- **Replacement procedure
For internal battery
(lithium battery)
(If the drawing number of
the basic unit is
A02B-0309-B52n,
A02B-0311-B52n, or
A02B-0311-B53n
(where n is 0, 1, ..., 9))**

Prepare a new battery unit (ordering code: A02B-0309-K102).

- 1) Turn on the power to the CNC. After about 30 seconds, turn off the power.
- 2) Extract the old battery unit from the lower right of the rear of the CNC unit. (Hold the latch of the battery unit, and extract the unit upward while releasing the claw from the case.)

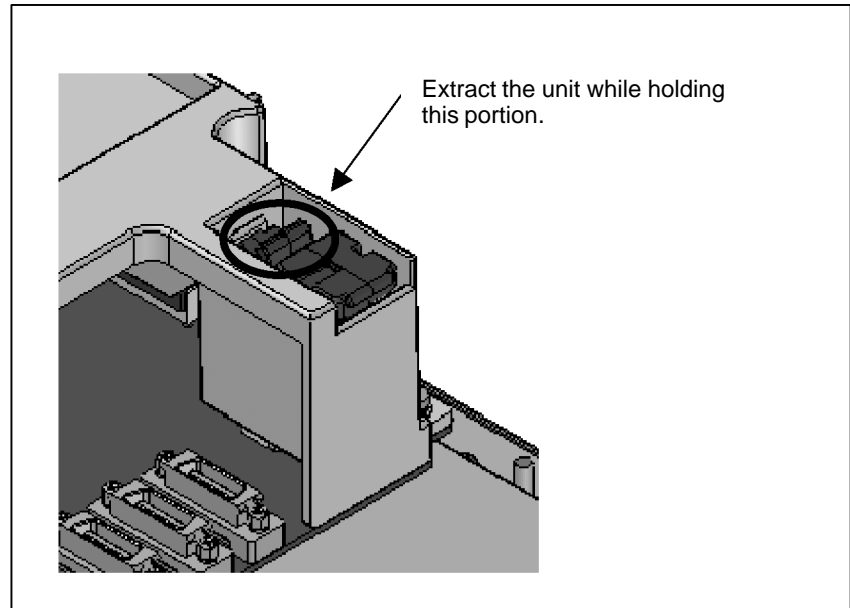

- 3) Mount the new battery unit. (Push the battery unit in until the claw is latched into the case.) Ensure that the latch is engaged securely.

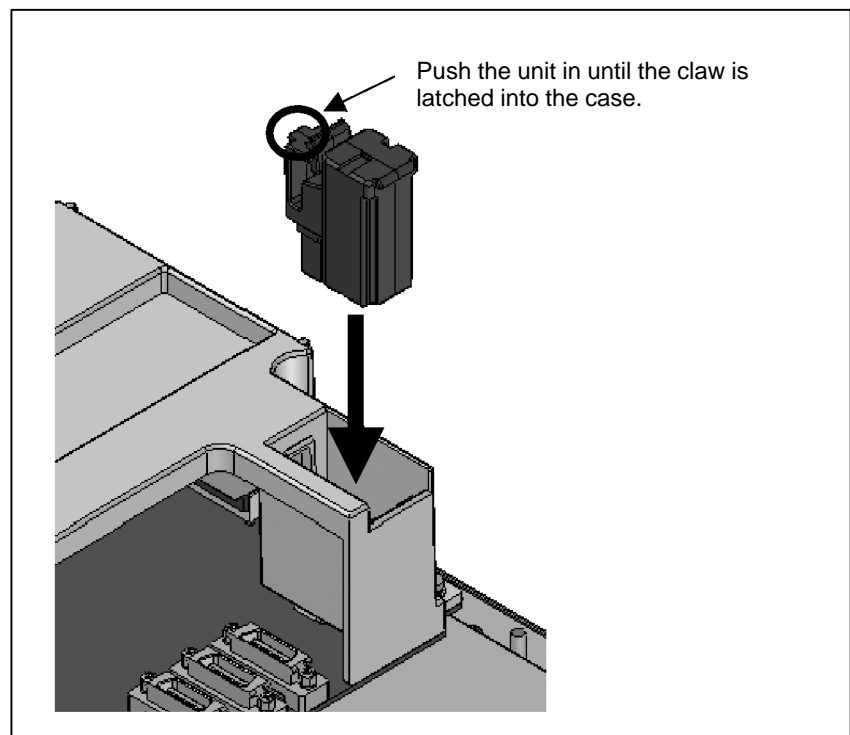

**WARNING**

Using other than the recommended battery may result in the battery exploding. Replace the battery only with the specified battery (A02B-0200-K102, A20B-0309-K102).

**CAUTION**

Steps 1) to 3) should be completed within 30 minutes. Do not leave the control unit without a battery for any longer than the specified period. Otherwise, the contents of memory may be lost.

If steps 1) to 3) may not be completed within 30 minutes, save all contents of the SRAM memory to the memory card beforehand. Thus, if the contents of the SRAM memory are lost, the contents can be restored easily.

For the method of operation, refer to 3.4 or C.2.

When discarding a battery, observe the applicable ordinances or other rules of your local government. Also, cover the terminals of the battery with vinyl tape or the like to prevent a short-circuit.

For separate battery unit

- 1) Prepare two alkaline dry cells (size D) commercially available.
- 2) Turn on the power to the control unit.
- 3) Remove the battery case cover.
- 4) Replace the cells, paying careful attention to their orientation.
- 5) Reinstall the cover onto the battery case.

⚠ CAUTION

When replacing the alkaline dry cells while the power is off, use the same procedure as that for lithium battery replacement described above.

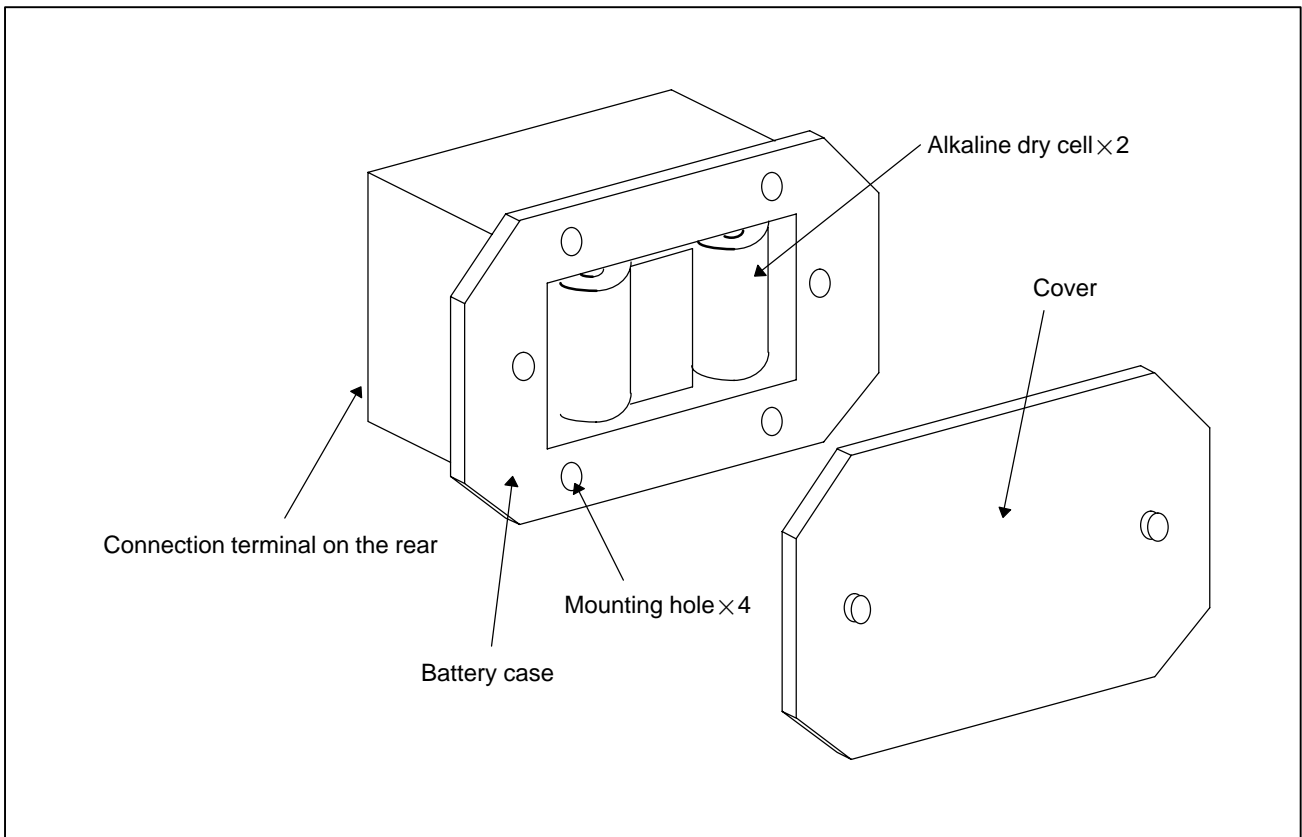

2.10.1 Battery for Separate Absolute Pulse Coders (6VDC)

One battery unit can maintain current position data for six absolute pulse coders for a year.

When the voltage of the battery becomes low, APC alarms 3n6 to 3n8 (n: axis number) are displayed on the LCD display. When APC alarm 3n7 is displayed, replace the battery as soon as possible. In general, the battery should be replaced within one or two weeks, however, this depends on the number of pulse coders used.

If the voltage of the battery becomes any lower, the current positions for the pulse coders can no longer be maintained. Turning on the power to the control unit in this state causes APC alarm 3n0 (reference position return request alarm) to occur. Return the tool to the reference position after replacing the battery.

Therefore, FANUC recommends that the battery be replaced once a year regardless of whether APC alarms are generated.

See Connection Manual (Hardware) (B-64113EN) for details of connecting the battery to separate absolute pulse coders.

Replacing batteries

Obtain four commercially available alkaline batteries (size D).

- (1) Turn on the power to the machine (Series 0i/0i Mate).
- (2) Loosen the screws of the battery case, and remove the cover.
- (3) Replace the dry batteries in the case.

Note the polarity of the batteries as shown in the figure below (orient two batteries one way and the other two in the opposite direction).

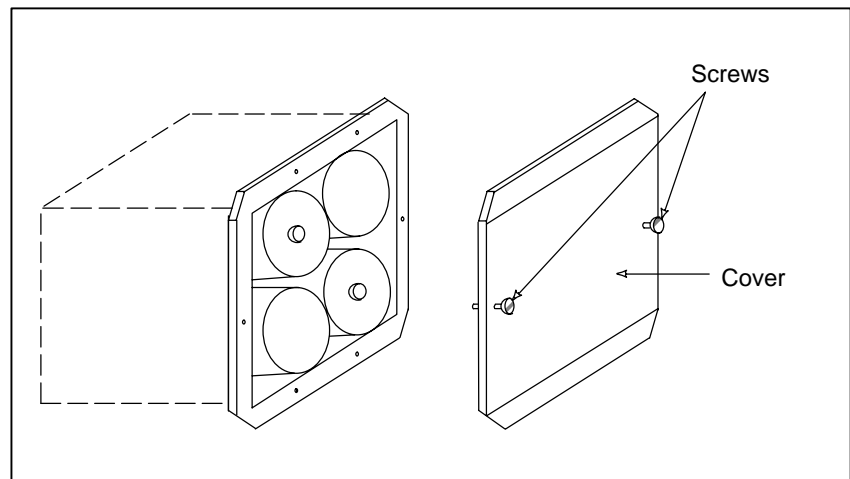

- (4) After installing the new batteries, replace the cover.
- (5) Turn off the power to the machine (Series 0i/0i Mate).

WARNING

If the batteries are installed incorrectly, an explosion may occur. Never use batteries other than the specified type (Size D alkaline batteries).

**CAUTION**

Replace batteries while the power to the CNC is on. Note that, if batteries are replaced while no power is supplied to the CNC, the recorded absolute position is lost.

2.10.2 Battery for Absolute Pulse Coder Built into the Motor (6VDC)

The battery for the absolute pulse coder built into the motor is installed in the servo amplifier. For how to connect and replace the battery, refer to the following manuals:

- FANUC SERVO MOTOR α i series Maintenance Manual
- FANUC SERVO MOTOR β series Maintenance Manual
- FANUC SERVO MOTOR β series (I/O Link Option) Maintenance Manual

2.11 REPLACING FAN MOTORS

WARNING

When opening the cabinet and replacing a fan motor, be careful not to touch the high-voltage circuits (marked  and fitted with an insulating cover).

Touching the uncovered high-voltage circuits presents an extremely dangerous electric shock hazard.

- **Fan ordering information**

If the drawing number of the basic unit is A02B-0309-B50n, A02B-0311-B50n, or A02B-0311-B51n (where n is 0, 1, ..., 9)

| | Ordering information | Required quantity |
|--------------------------|----------------------|-------------------|
| Unit with no option slot | A02B-0236-K120 | 2 |
| Unit with 2 option slots | A02B-0281-K121 | 2 |

If the drawing number of the basic unit is A02B-0309-B52n, A02B-0311-B52n, or A02B-0311-B53n (where n is 0, 1, ..., 9)

| | Ordering information | Mounting location | Required quantity |
|--------------------------|----------------------|-------------------|-------------------|
| Unit with no option slot | A02B-0309-K120 | Right | 1 |
| | A02B-0309-K120 | Left | 1 |
| Unit with 2 option slots | A02B-0309-K120 | Right | 1 |
| | A02B-0309-K121 | Left | 1 |

Replacement procedure

If the drawing number of the basic unit is A02B-0309-B50n, A02B-0311-B50n, or A02B-0311-B51n (where n is 0, 1, ..., 9)

1. Before replacing a fan motor, turn off the power to the CNC.
2. Unplug the connector of a fan motor to be replaced ((1) of Fig. a). The connector is latched. So, when unplugging the connector, hold down the latch placed at the lower part of the connector with a flat-blade screwdriver.
3. Detach the latch securing the fan motor, then demount the fan motor ((2) of Fig. a).
4. Insert a new fan motor into the fan case ((3) of Fig. a), then reconnect the connector.

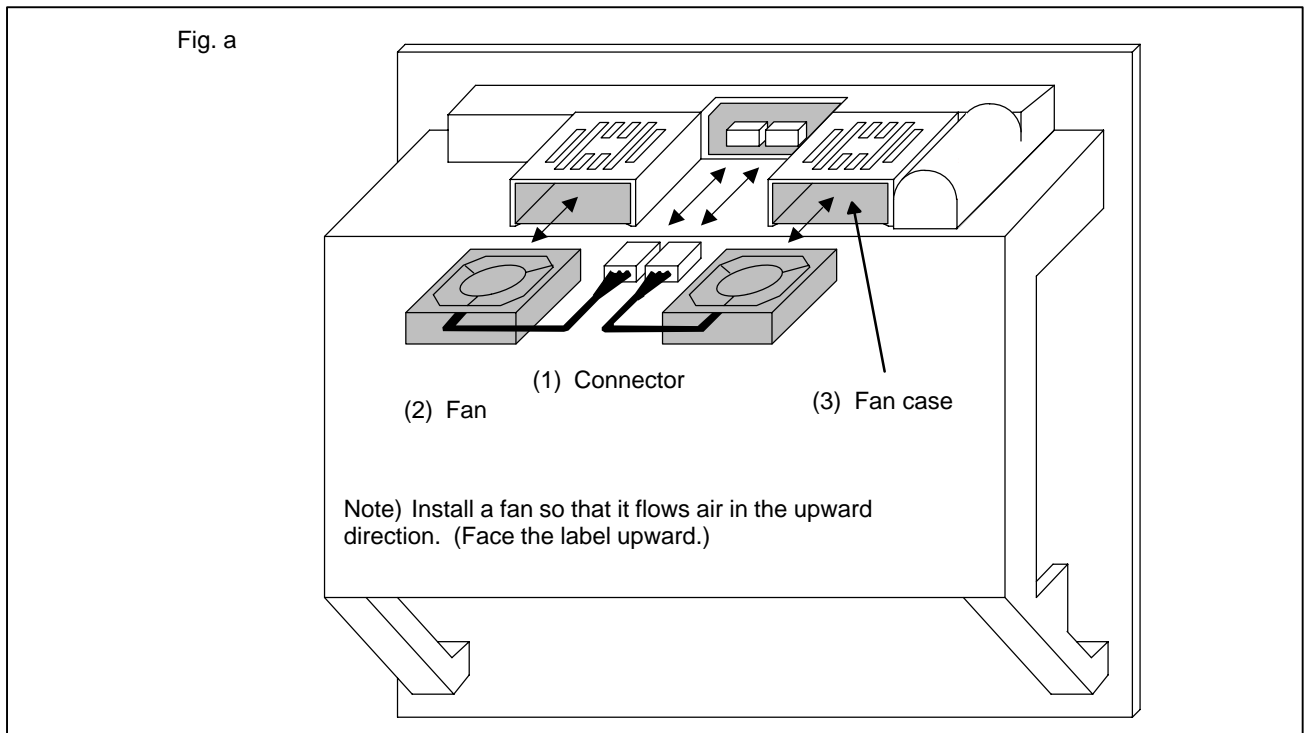

If the drawing number of the basic unit is A02B-0309-B52n, A02B-0311-B52n, or A02B-0311-B53n (where n is 0, 1, ..., 9)

- 1) Before replacing a fan motor, turn off the power to the CNC.
- 2) Extract the fan motor to be replaced. (Hold the latch of the fan unit, and extract the unit upward while releasing the claw from the case.)

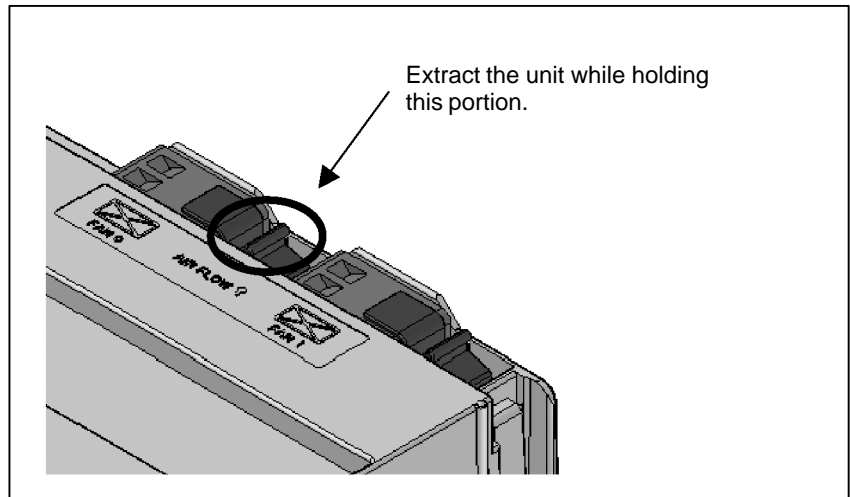

- 3) Mount a new fan unit. (Push the fan unit in until the claw is latched into the case.)

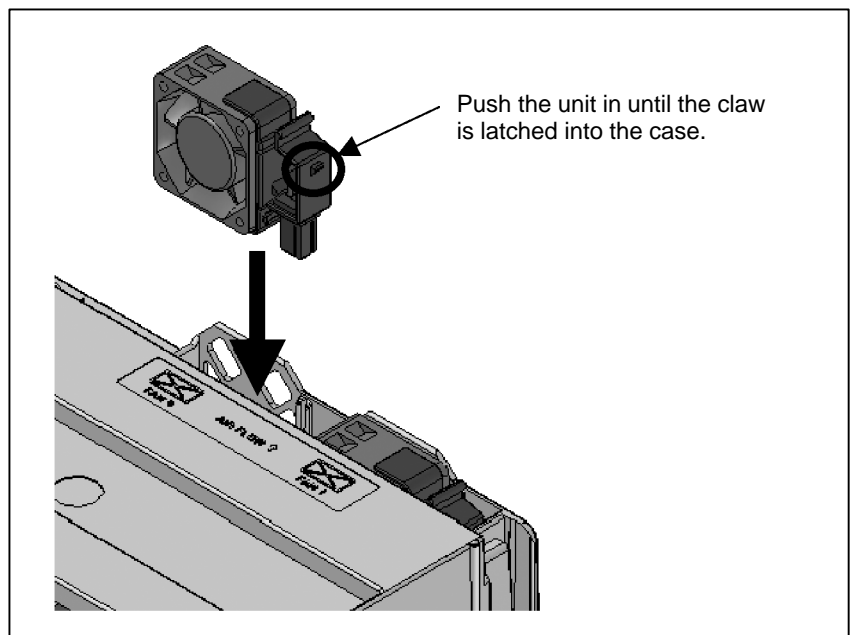

2.12 REPLACING LCD BACKLIGHT

WARNING

Only those personnel who have received approved safety and maintenance training may perform this replacement work.

When opening the cabinet and replacing a unit, be careful not to touch the high-voltage circuits (marked  and fitted with an insulating cover).

Touching the uncovered high-voltage circuits presents an extremely dangerous electric shock hazard.

CAUTION

Before starting replacement work, back up the contents (such as parameters and programs) of the SRAM memory of the CNC. Otherwise, the contents of the SRAM memory may be lost during replacement work.

Brightness of the monochrome LCD

When the ambient temperature is low, the brightness of the LCD decreases. (The LCD screen is dark particularly immediately after the power is turned on.) This phenomenon is not a failure but is a property specific to the LCD. When the ambient temperature increases, the LCD screen becomes brighter. The monochrome LCD has a brightness control function. For the method of adjustment, see Section 1.17.

• Backlight ordering information

| Backlight | Ordering information |
|---------------|----------------------|
| For 7.2" LCD | A02B-0236-K112 |
| For 8.4" LCD | A02B-0236-K119 |
| For 10.4" LCD | A02B-0309-K116 |

• Replacement procedure

Replacing a horizontal type LCD/MDI unit

- 1) Detach the soft key and memory card cables from the main board. Remove the two screws shown below. (If it is hard to detach the memory card cable, detach the basic unit case before it.)

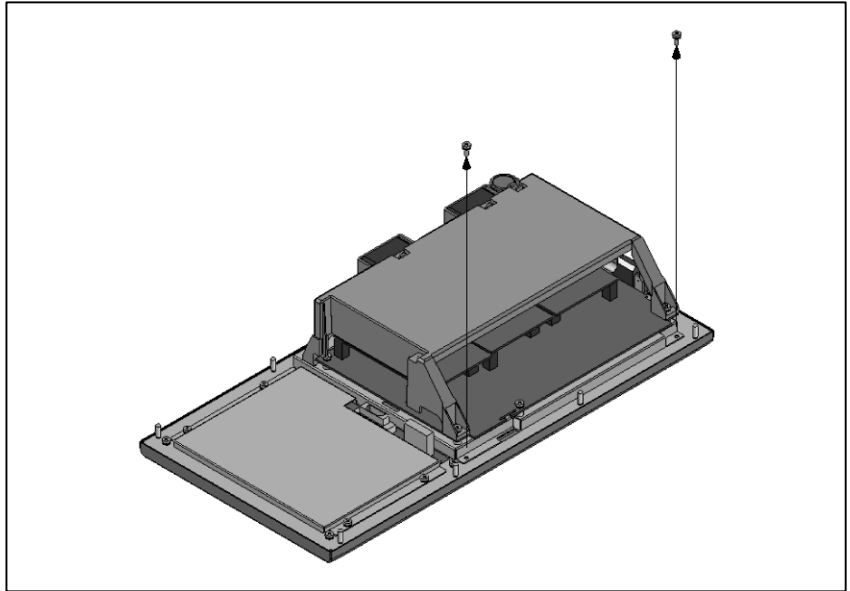

- 2) Lift the basic unit block by pivoting it on its upper portion.

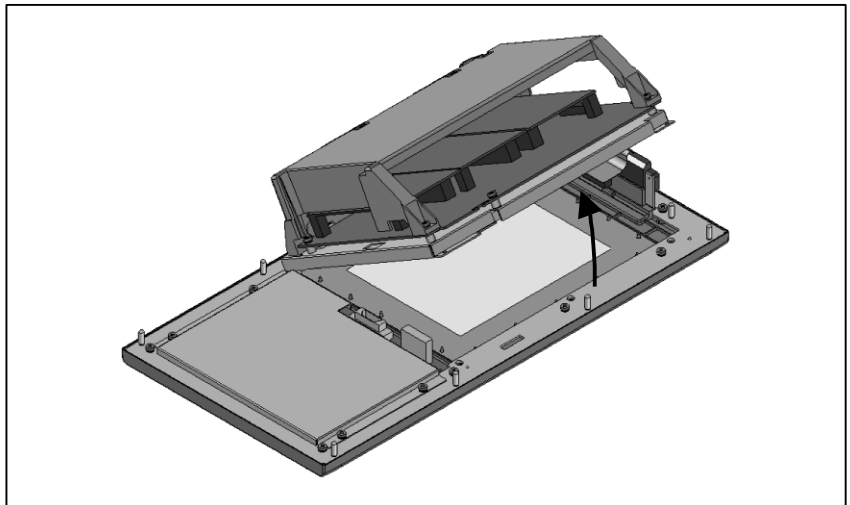

- 3) Under the condition attained in step 2), slide the basic unit block down a little and detach it from the notches of the base metal plate.

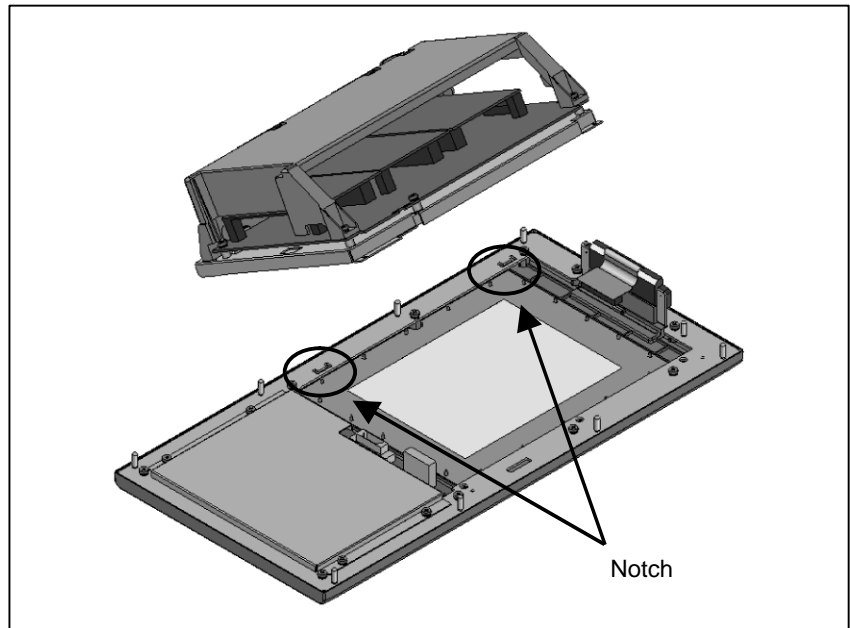

- 4) Turn over the basic unit, and you will see the LCD panel.

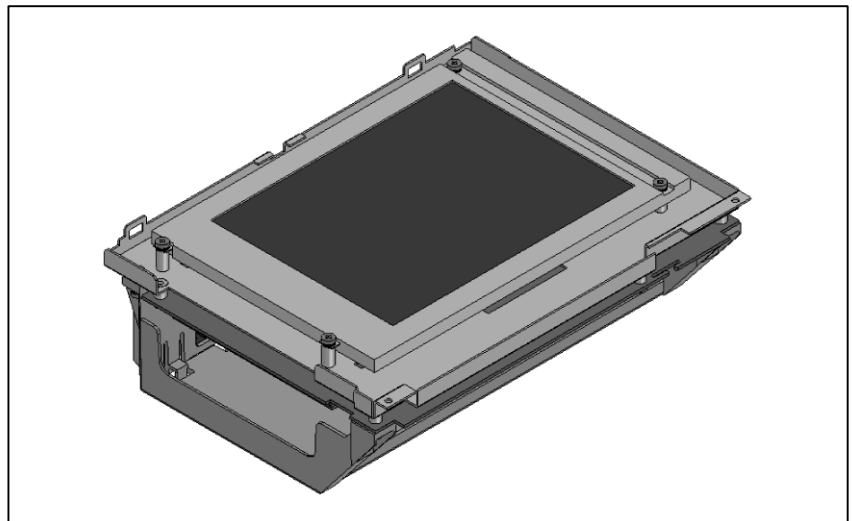

- 5) Remove the inverter cable and then four fastening screws from the LCD panel. Now the LCD panel can be detached.

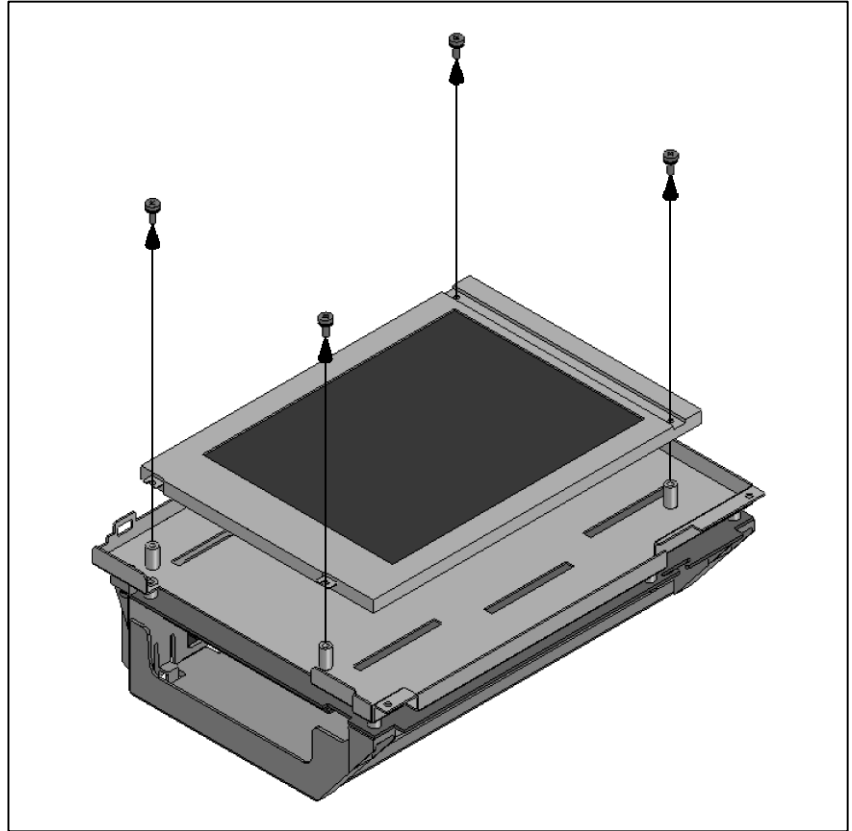

Replacing a vertical type LCD/MDI unit

- 1) Detach the memory card cable from the main board. Remove the three screws shown below. (If it is hard to detach the memory card cable, detach the basic unit case before it.)

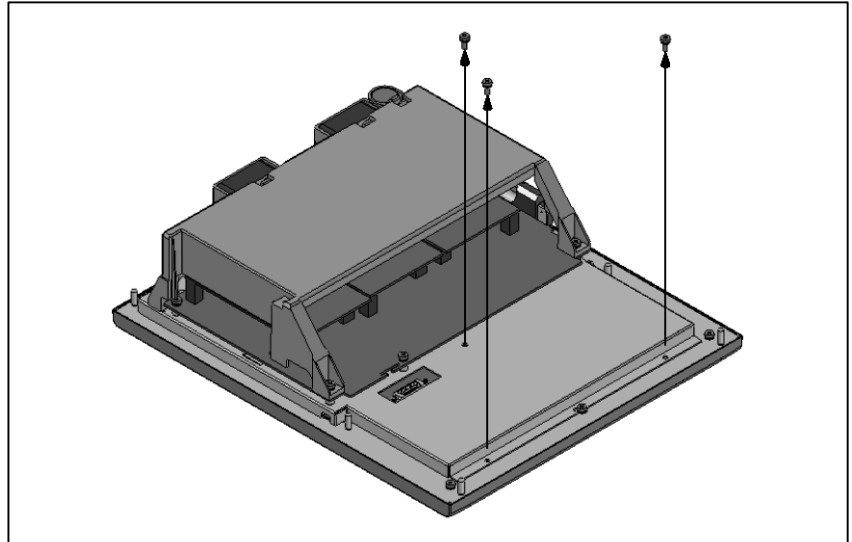

- 2) Lift the basic unit block by pivoting it on its upper portion.

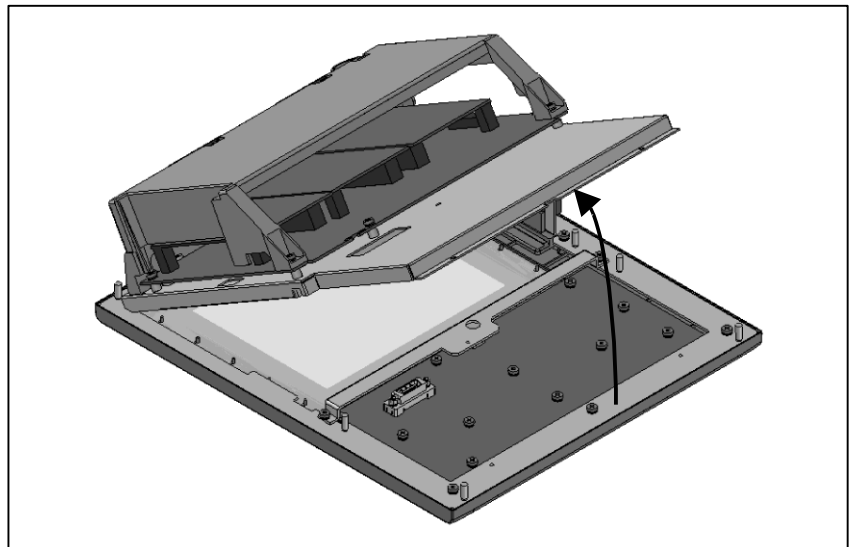

- 3) Under the condition attained in step 2), slide the basic unit block down a little and detach it from the notches of the base metal plate.

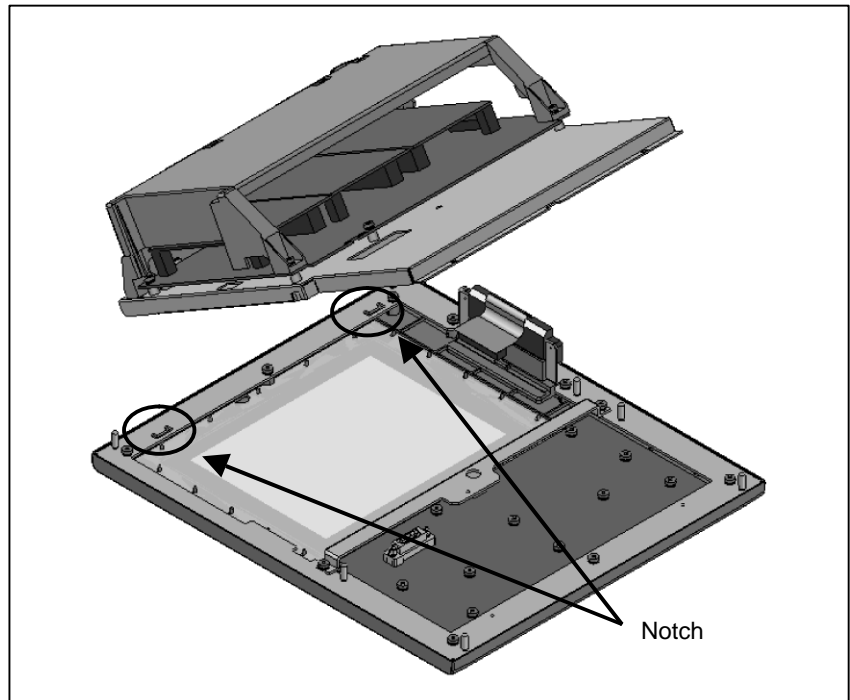

- 4) Turn over the basic unit, and you will see the LCD panel.

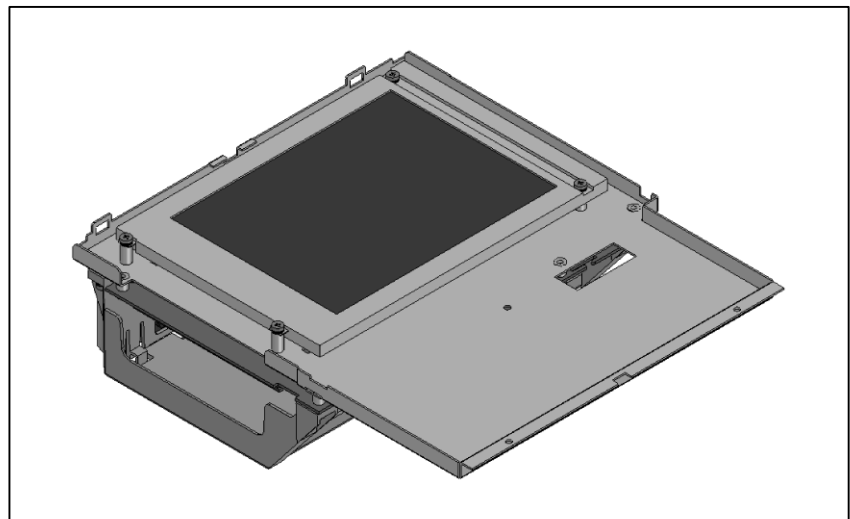

- 5) Remove the inverter cable and then four fastening screws from the LCD panel. Now the LCD panel can be detached.

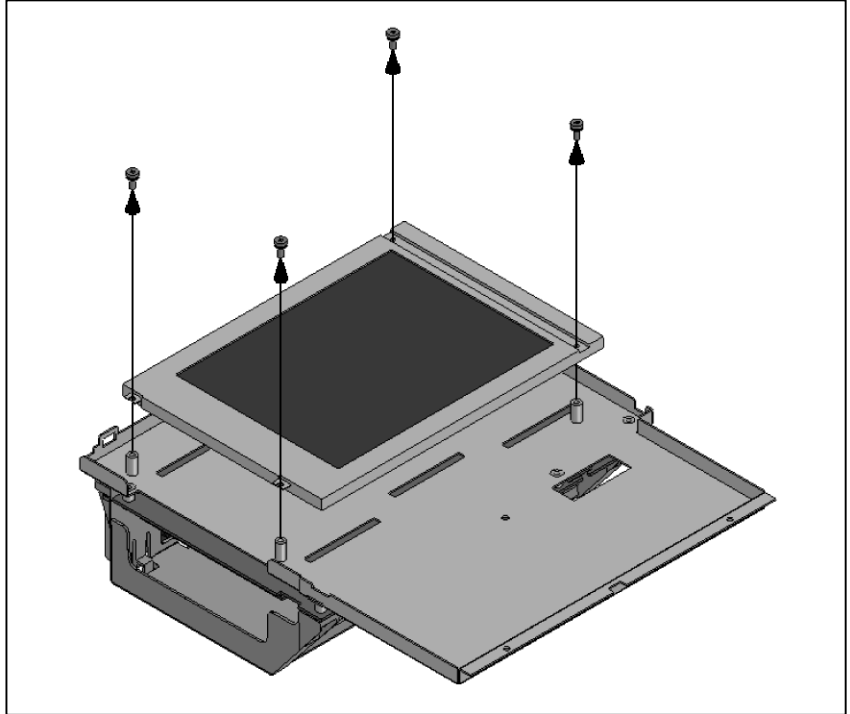

- 6)-1 For the 7.2" LCD unit (monochrome)
Remove the three screws from the left part on the front of the LCD unit, and remove the cover. Then, the backlight is exposed. Replace the backlight with a new one.

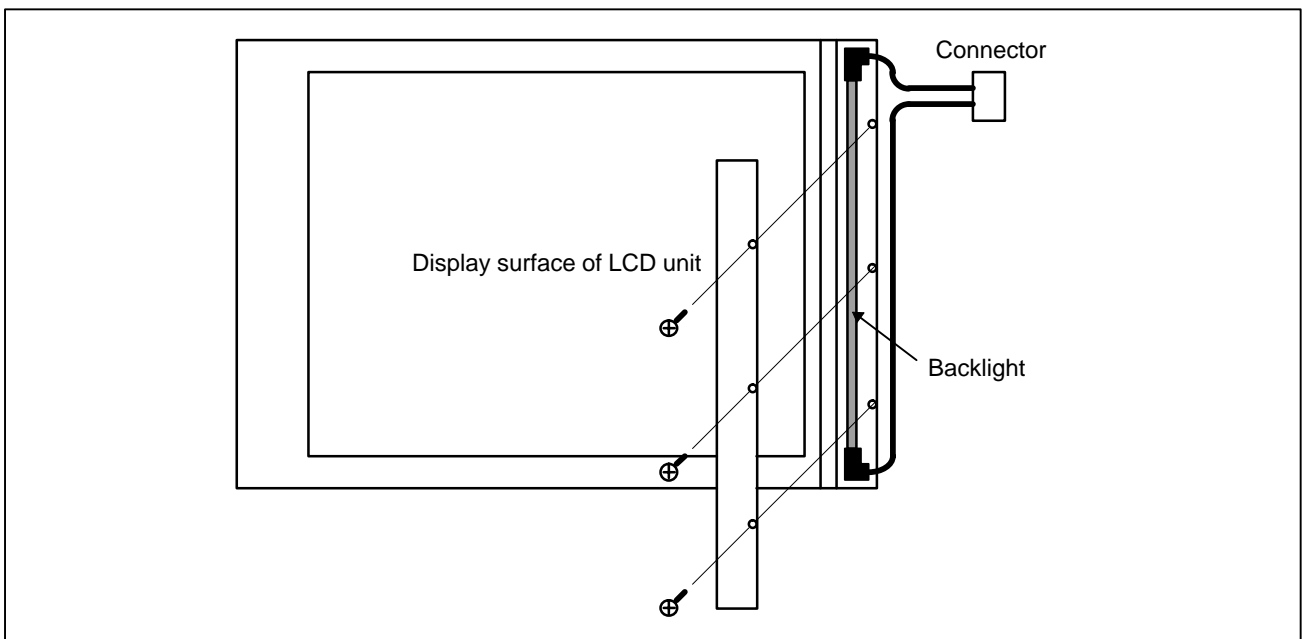

6)-2 For the 8.4" LCD (color)

As shown below, remove two bolts, remove the backlight case by pulling it down and sliding it slightly to the left, then replace the backlight.

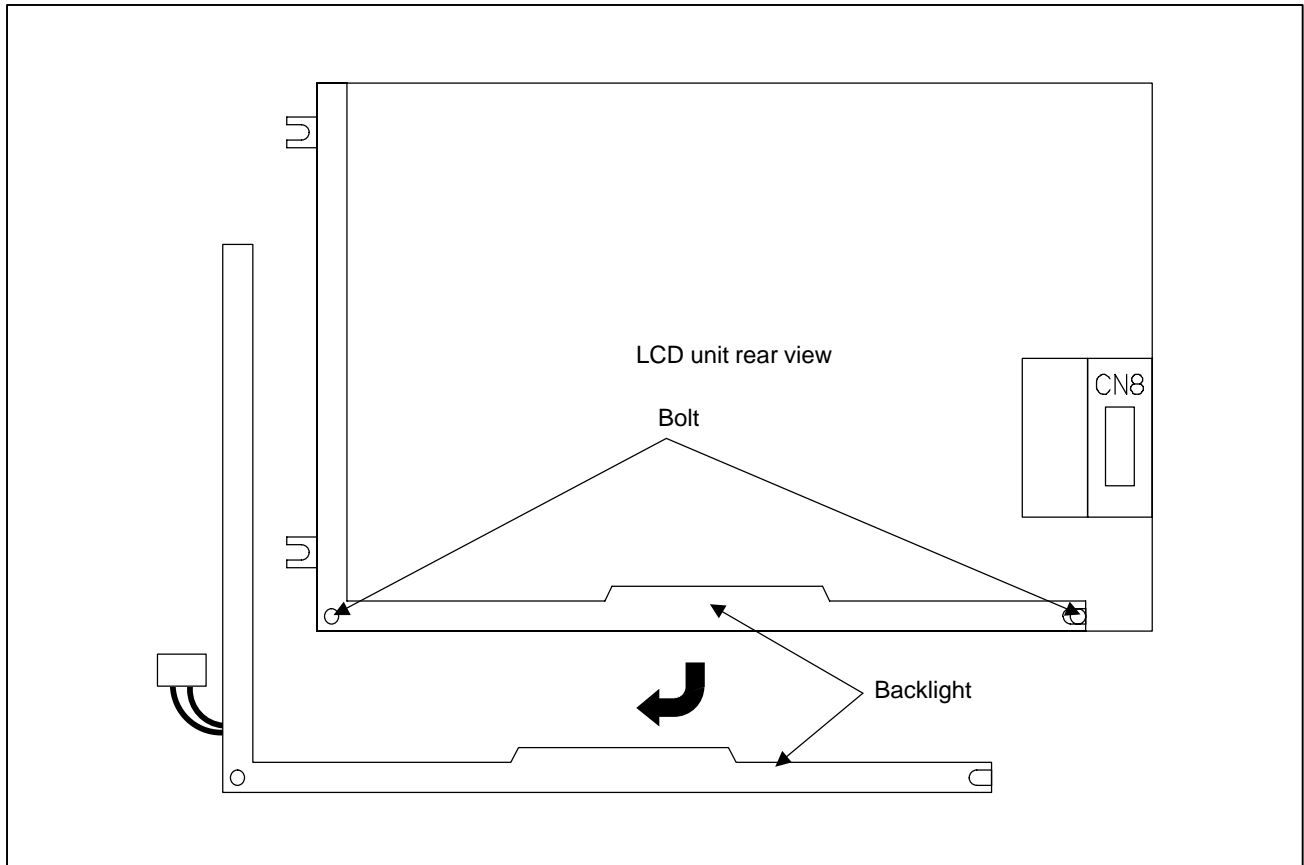

6)-3 For the 10.4" LCD (color)
Pull out the inverter as shown below.

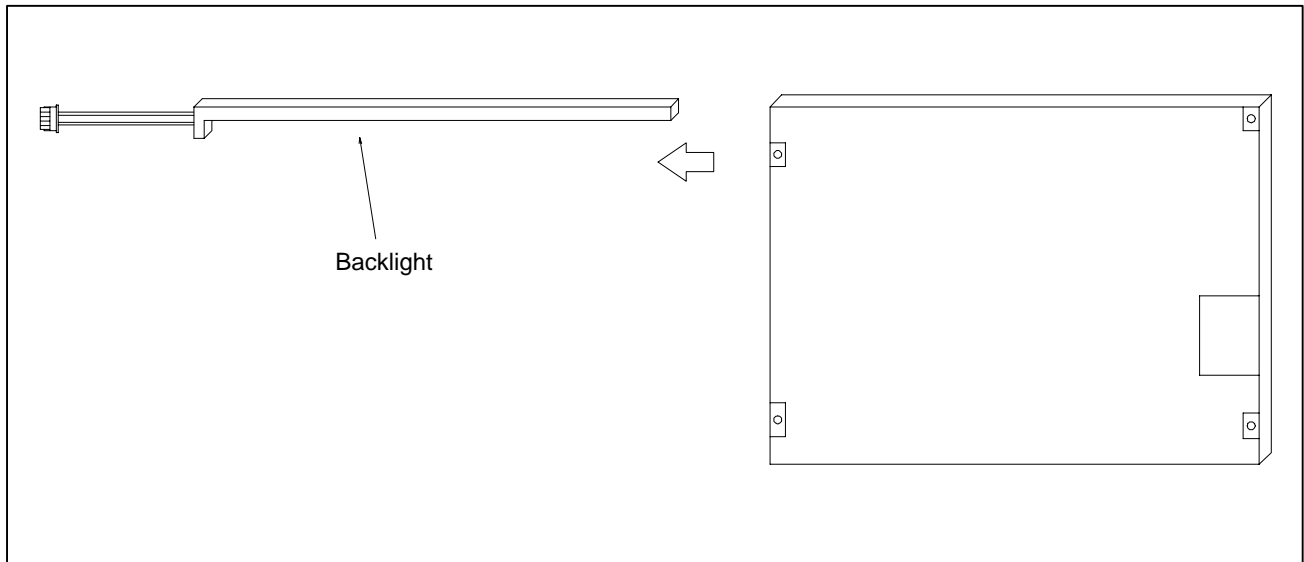

2.13 DISTRIBUTED I/O SETTING

By changing the setting (rotary switch) on an expansion module, a connection can be made to skip an expansion module or expansion modules as shown below.

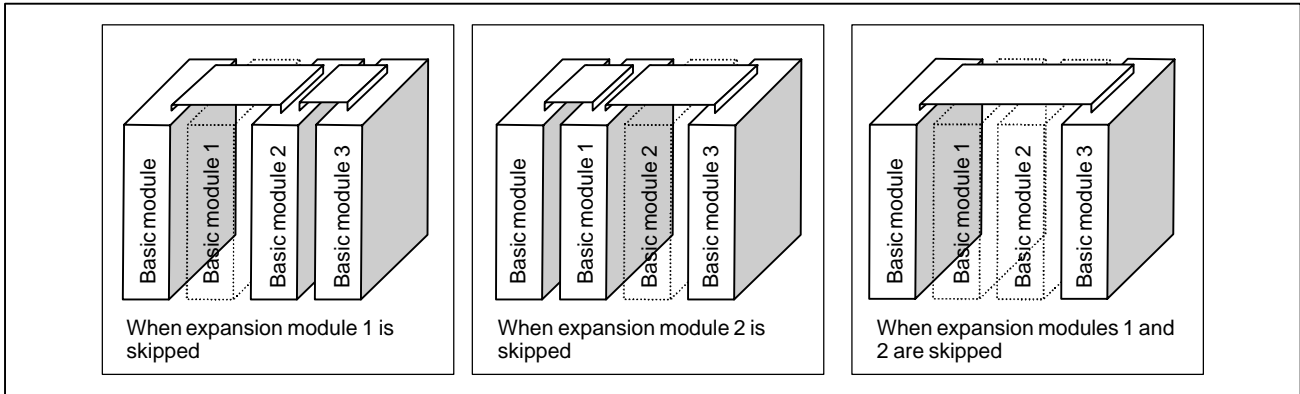

Method of setting (control and setting method)

A control (rotary switch) is provided on the location shown below of each expansion module. When changing the setting, turn the rotary switch with a flat-blade screwdriver with a tip diameter of about 2.5 mm.

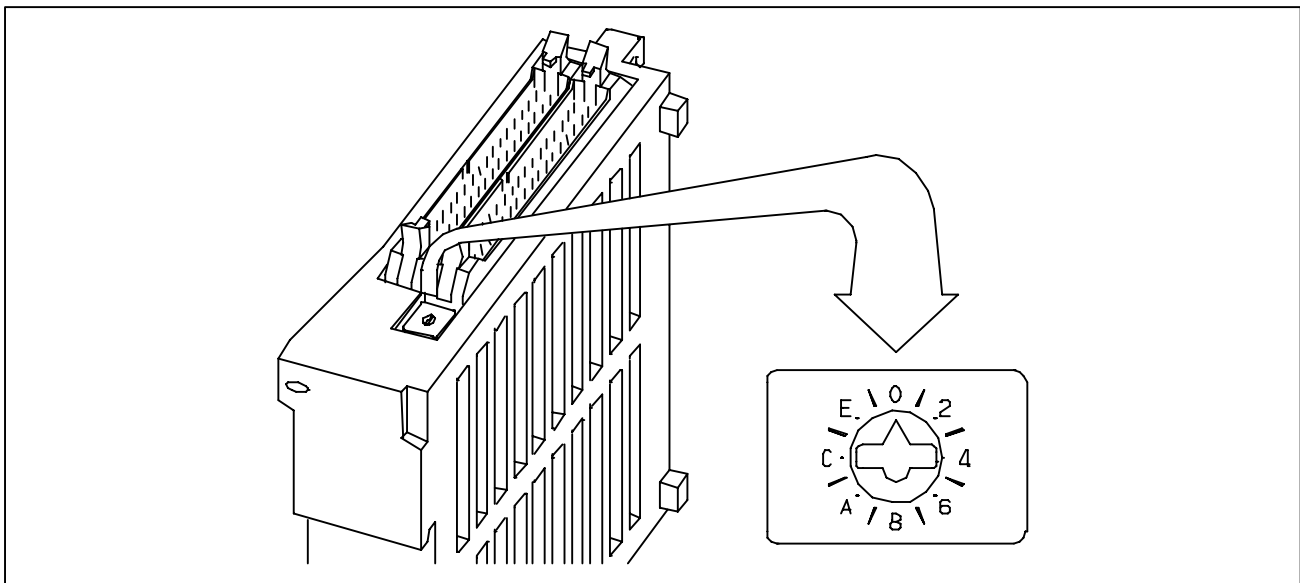

Each setting position of the rotary switch has the meaning as indicated below.

| Setting position | Indication | Meaning of setting |
|------------------|--|---|
| 0 | 0 | Standard setting. The rotary switch is set to this position at the time of shipment from FANUC. This setting is not skipped an expansion module. |
| 1 | — | Set the rotary switch of an expansion module to this position when the one preceding expansion module is skipped. |
| 2 | 2 | Set the rotary switch of an expansion module to this position when the two preceding expansion modules are skipped. |
| 3 | — | Setting prohibited |
| 4 to F | 4, —, 6, —, 8, —, A, —, C, —, E, — | 4, 8, or C has the effect of 0. 5, 9, or D has the effect of 1. 6, A, or E has the effect of 2. 7, B, or F has the effect of 3. (← setting prohibited) |

Examples of setting

(When expansion module 1 is skipped)
Set the rotary switch of expansion module 2 to setting position = 1. Do not change the setting (setting position = 0) of expansion module 3.

(When expansion module 1 and expansion module 2 are skipped)
Set the rotary switch of expansion module 3 to setting position = 2.

(When expansion module 2 is skipped)
Set the rotary switch of expansion module 3 to setting position = 1. Do not change the setting (setting position = 0) of expansion module 1.

This function was not available initially, but was recently added. This function became available, depending on the type of module, as indicated below.

| | |
|--|----------------|
| Expansion module B (DI/DO = 24/16, without a manual pulse generator interface) | A03B-0815-C003 |
| Expansion module C (DO = 16, 24A output) | A03B-0815-C004 |
| Expansion module D (analog input) | A03B-0815-C005 |

NOTE

To expansion module A (DI/DO = 24/16, with a manual pulse generator interface) (A03B-0815-C002), a rotary switch is added as the other modules are modified. However, expansion module A is always installed at the location of expansion module 1, so that the setting of expansion module A need not be changed.

2.14 REPLACING FUSES ON VARIOUS UNITS



WARNING

Before replacement of a blown fuse, the cause of the blown fuse must be corrected. So, fuse replacement work must be done only by a person who is trained in the related maintenance and safety requirements. When opening the cabinet and replacing a fuse inside, be careful not to touch the high-voltage circuits (marked with  and fitted with an insulating cover). Touching the uncovered high-voltage circuits presents an extremely dangerous electric shock hazard.

For the specification of the fuse of each unit, see the list of consumables in Appendix B.

- **Fuse mounting location on the connector panel I/O modules**

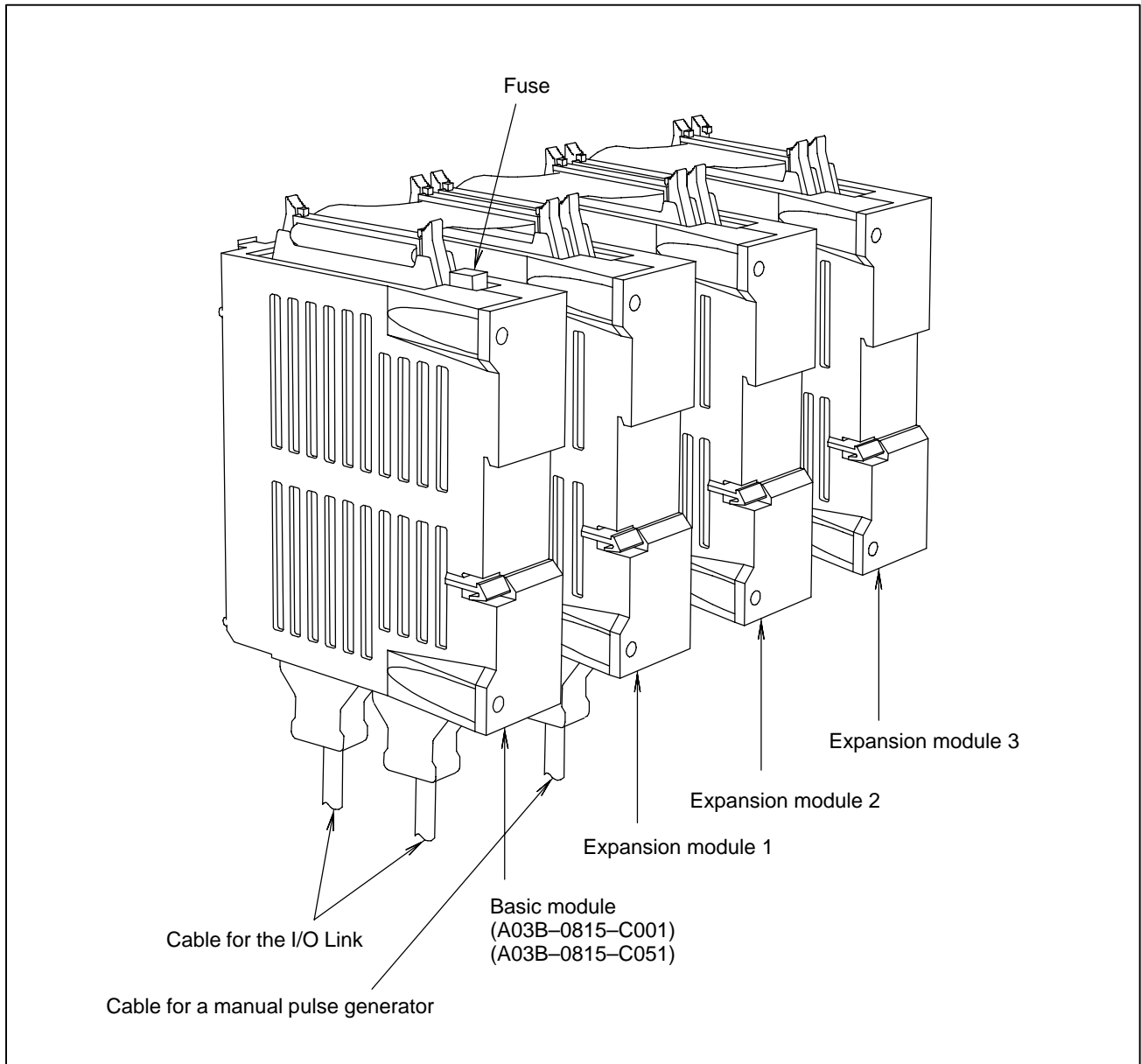
**NOTE**

No fuse is provided on the expansion modules. A fuse is provided on the basic module only.

- **Fuse mounting location on the operator's panel I/O modules**

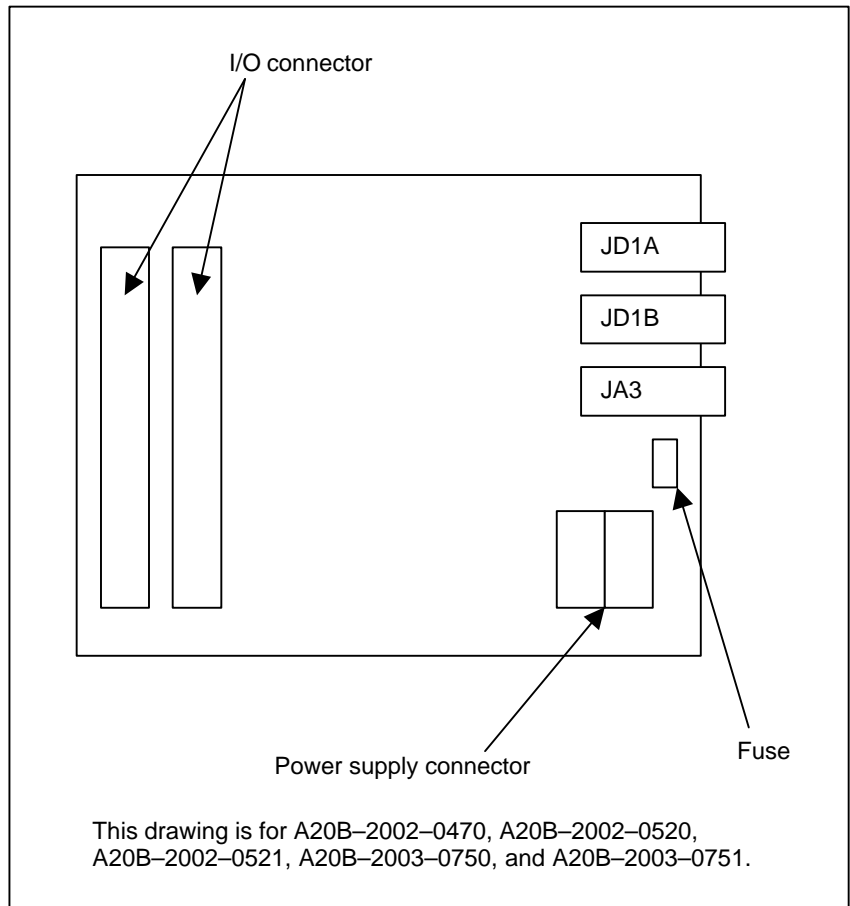

- **Fuse mounting location on the separate detector interface unit**

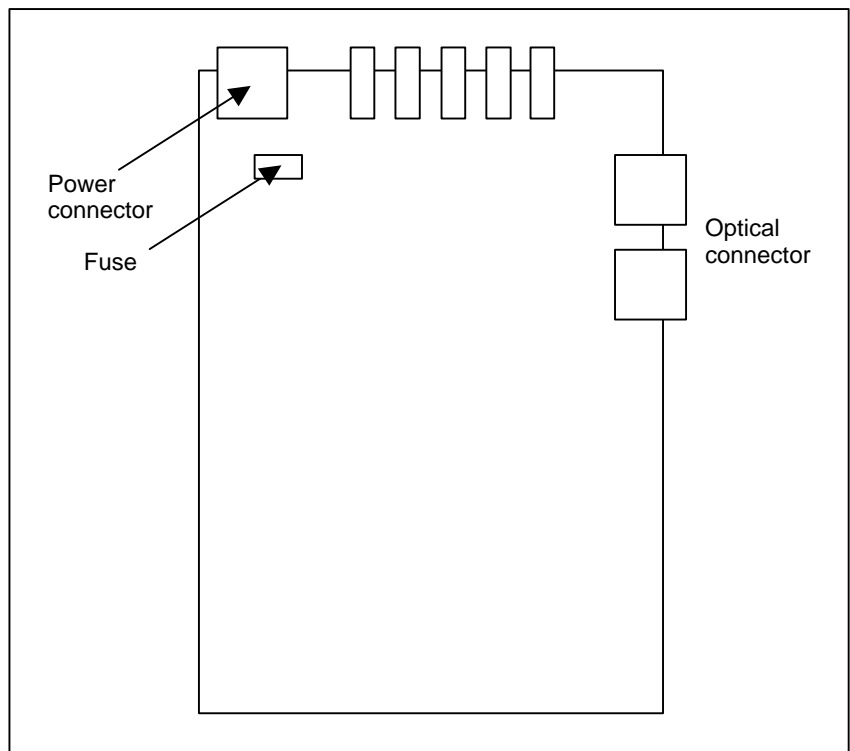

2.15 ENVIRONMENTAL REQUIREMENTS OUTSIDE THE CONTROL UNIT

The peripheral units and the control unit have been designed on the assumption that they are housed in closed cabinets. In this manual “cabinet” refers to the following:

- Cabinet manufactured by the machine tool builder for housing the control unit or peripheral units;
- Operation pendant, manufactured by the machine tool builder, for housing the control unit or operator’s panel.
- Equivalent to the above.

The environmental conditions when installing these cabinets shall conform to the following table. Section 3.3 describes the installation and design conditions of a cabinet satisfying these conditions.

| | | |
|-------------------------------|--|--------------------------------|
| Ambient Temperature | Operating | 0°C to 58°C |
| | Storage, Transport | -20°C to 60°C |
| Temperature change | | 1.1°C/minute (maximum) |
| Humidity | Normal | 75%RH or less, no condensation |
| | Short period (less than 1 month) | 95%RH or less, no condensation |
| Vibration | Operating | 0.5 G or less |
| | Non-operating | 1.0 G or less |
| Meters above sea level | Operating | Up to 1000 m |
| | Non-operating | Up to 12000 m |
| Environment | Normal machine shop environment (The environment must be considered if the cabinets are in a location where the density of dust, coolant, and/or organic solvent is relatively high.) | |

2.16 ACTION AGAINST NOISE

The CNC has been steadily reduced in size using surface-mount and custom LSI technologies for electronic components. The CNC also is designed to be protected from external noise. However, it is difficult to measure the level and frequency of noise quantitatively, and noise has many uncertain factors. It is important to prevent both noise from being generated and generated noise from being introduced into the CNC. This precaution improves the stability of the CNC machine tool system.

The CNC component units are often installed close to the parts generating noise in the power magnetics cabinet. Possible noise sources into the CNC are capacitive coupling, electromagnetic induction, and ground loops.

When designing the power magnetics cabinet, guard against noise in the machine as described in the following section.

2.16.1 Separating Signal Lines

The cables used for the CNC machine tool are classified as listed in the following table:

Process the cables in each group as described in the action column.

| Group | Signal line | Action |
|-------|---|--|
| A | Primary AC power line | Bind the cables in group A separately (Note 1) from groups B and C, or cover group A with an electromagnetic shield (Note 2). See Subsec. 2.16.4 and connect spark killers or diodes with the solenoid and relay. |
| | Secondary AC power line | |
| | AC/DC power lines (containing the power lines for the servo and spindle motors) | |
| | AC/DC solenoid | |
| | AC/DC relay | |
| B | DC solenoid (24VDC) | Connect diodes with DC solenoid and relay. |
| | DC relay (24VDC) | Bind the cables in group B separately from group A, or cover group B with an electromagnetic shield. |
| | DI/DO cable between the CNC and power magnetics cabinet | |
| | DI/DO cable between the CNC and machine | Separate group B as far from Group C as possible. It is more desirable to cover group B with the shield. |

| Group | Signal line | Action |
|-------|---|--|
| C | Cable for position and velocity feedback | Bind the cables in group C separately from group A, or cover group C with an electromagnetic shield. Separate group C as far from Group B as possible. Be sure to perform shield processing in Subsec. 2.16.5. |
| | Cable between the CNC and spindle amplifier | |
| | Cable for the position coder | |
| | Cable for the manual pulse generator | |
| | Cable between the CNC and the CRT/MDI | |
| | RS-232-C and RS-422 interface cable | |
| | Cable for the battery | |
| | Other cables to be covered with the shield | |

NOTE

- 1 The groups must be 10 cm or more apart from one another when binding the cables in each group.
- 2 The electromagnetic shield refers to shielding between groups with grounded steel plates.

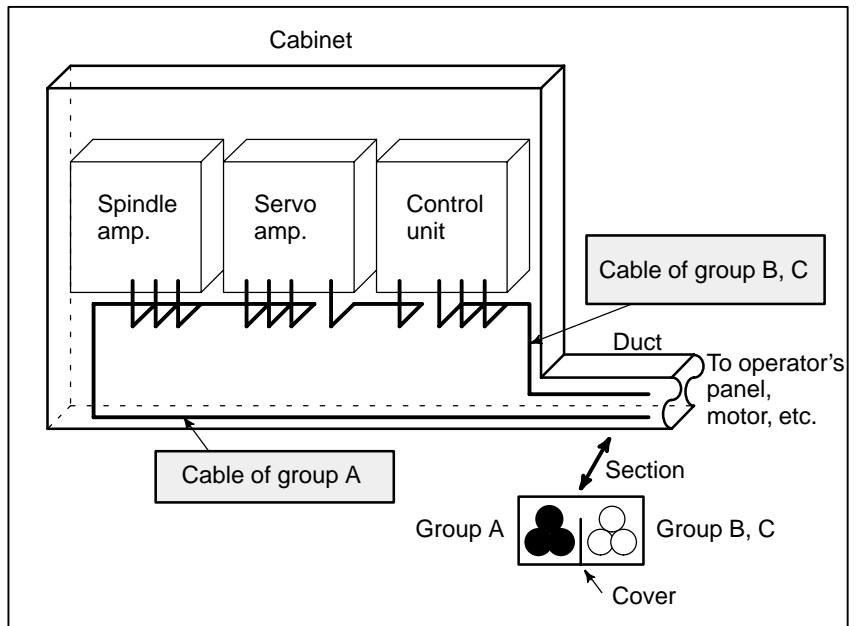

2.16.2 Ground

The following ground systems are provided for the CNC machine tool:

(1) Signal ground system (SG)

The signal ground (SG) supplies the reference voltage (0 V) of the electrical signal system.

(2) Frame ground system (FG)

The frame ground system (FG) is used for safety, and suppressing external and internal noises. In the frame ground system, the frames, cases of the units, panels, and shields for the interface cables between the units are connected.

(3) System ground system

The system ground system is used to connect the frame ground systems connected between devices or units with the ground.

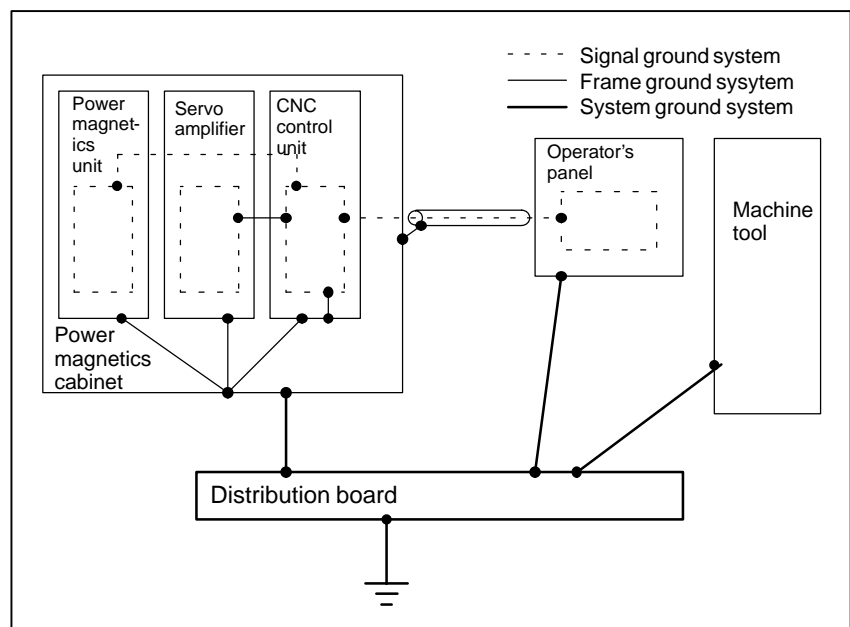

Notes on connecting the ground systems

- Connect the signal ground with the frame ground (FG) at only one place in the CNC control unit.
- The grounding resistance of the system ground shall be 100 ohms or less (class 3 grounding).
- The system ground cable must have enough cross-sectional area to safely carry the accidental current flow into the system ground when an accident such as a short circuit occurs. (Generally, it must have the cross-sectional area of the AC power cable or more.)
- Use the cable containing the AC power wire and the system ground wire so that power is supplied with the ground wire connected.

2.16.3 Connecting the Ground Terminal of the Control Unit

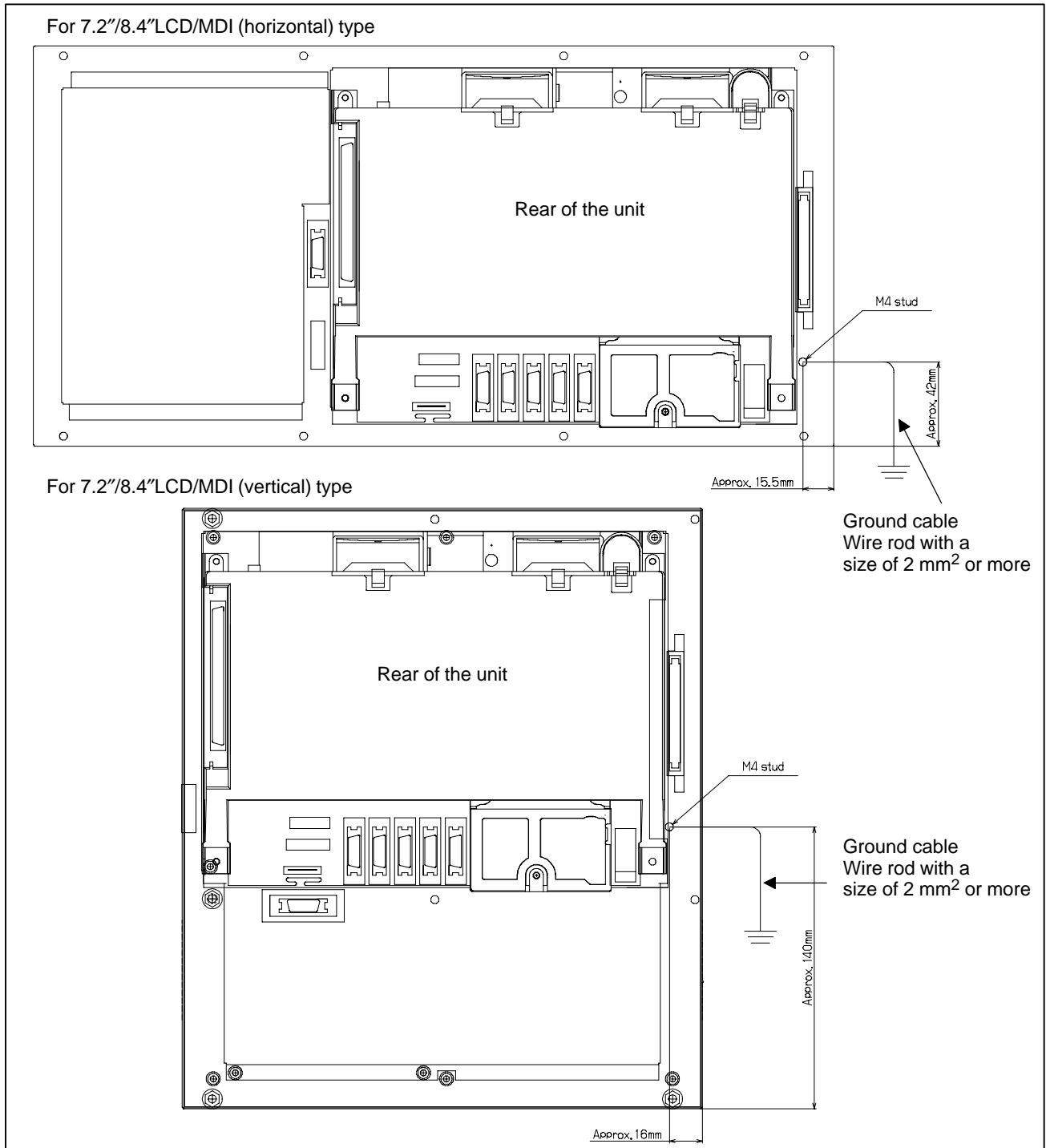

Connect the 0 V line in the control unit to the ground plate of the cabinet via the protective ground terminal (shown in the above figure). For the positions of ground terminals for other units, see the unit outline drawing in the appendix.

2.16.4 Noise Suppressor

The AC/DC solenoid and relay are used in the power magnetics cabinet. A high pulse voltage is caused by coil inductance when these devices are turned on or off.

This pulse voltage induced through the cable causes the electronic circuits to be disturbed.

Notes on selecting the spark killer

- Use a spark killer consisting of a resistor and capacitor in series. This type of spark killer is called a CR spark killer.(Use it under AC)
(A varistor is useful in clamping the peak voltage of the pulse voltage, but cannot suppress the sudden rise of the pulse voltage. FANUC therefore recommends a CR spark killer.)

- The reference capacitance and resistance of the spark killer shall conform to the following based on the current (I (A)) and DC resistance of the stationary coil:

1) Resistance (R) : Equivalent DC resistance of the coil

2) Capacitance (C) : $\frac{I^2}{10}$ to $\frac{I^2}{20}$ (μF)

I : Current at stationary state of the coil

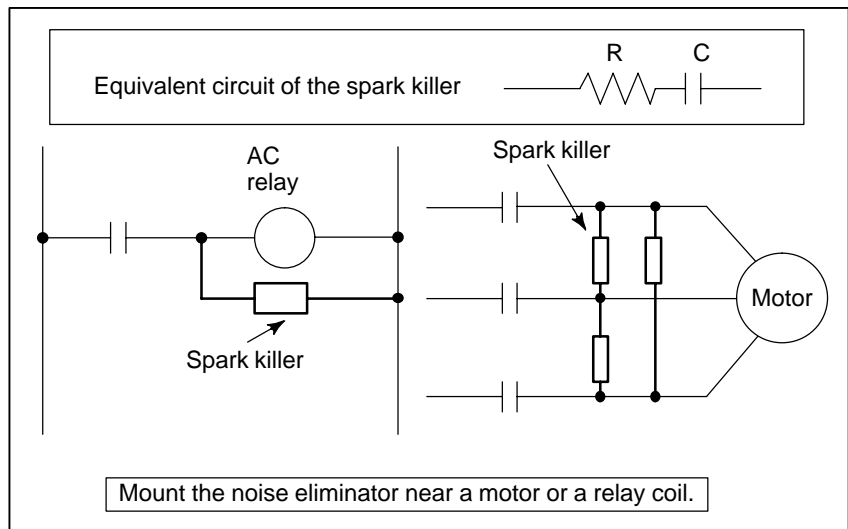

NOTE

Use a CR-type noise eliminator. Varistor-type noise eliminators clamp the peak pulse voltage but cannot suppress a sharp rising edge.

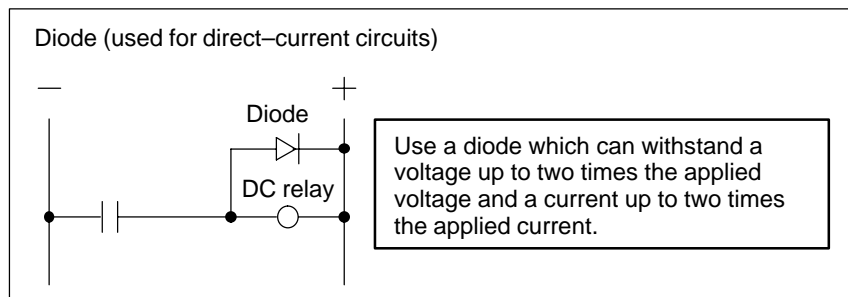

2.16.5 Cable Clamp and Shield Processing

The CNC cables that require shielding should be clamped by the method shown below. This cable clamp treatment is for both cable support and proper grounding of the shield. To insure stable CNC system operation, follow this cable clamp method.

Partially peel out the sheath and expose the shield. Push and clamp by the plate metal fittings for clamp at the part. The ground plate must be made by the machine tool builder, and set as follows :

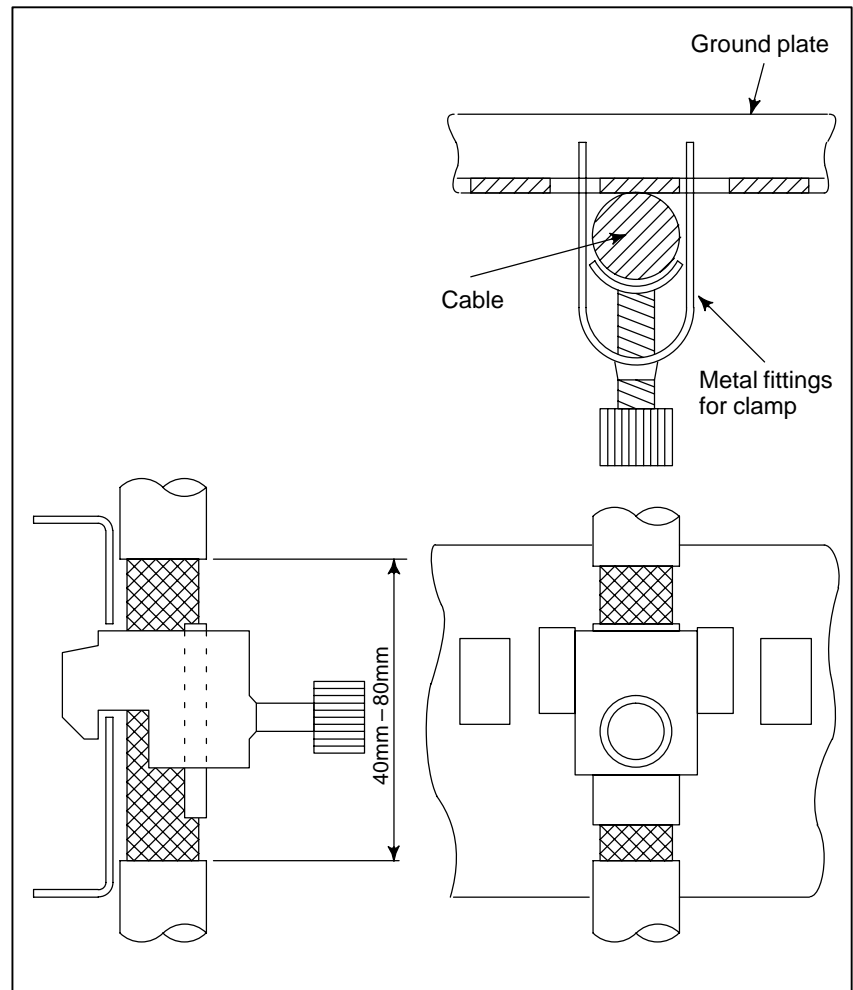

Fig. 2.16.5 (a) Cable clamp (1)

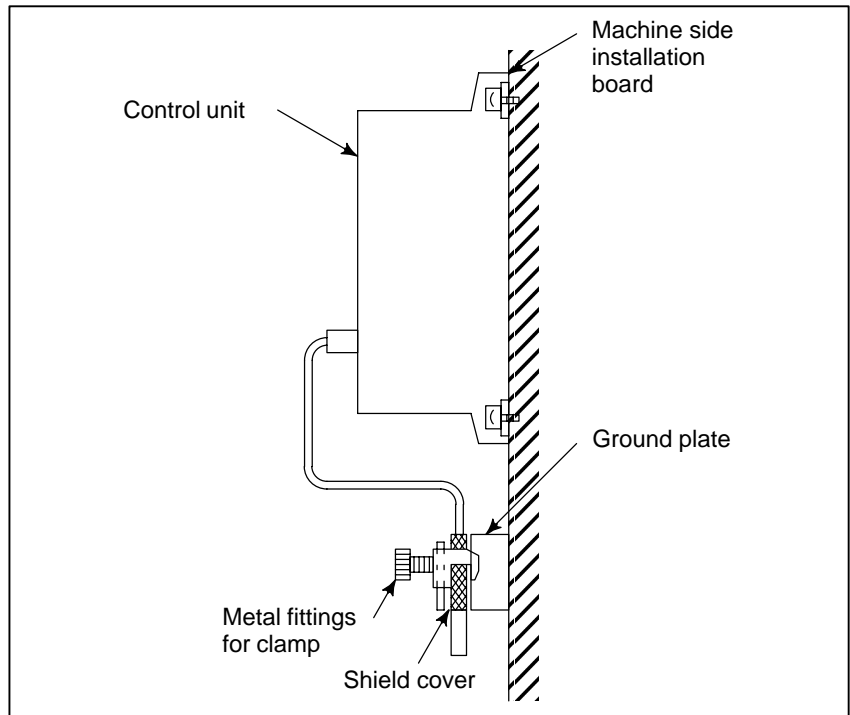

Fig. 2.16.5 (b) Cable clamp (2)

Prepare ground plate like the following figure.

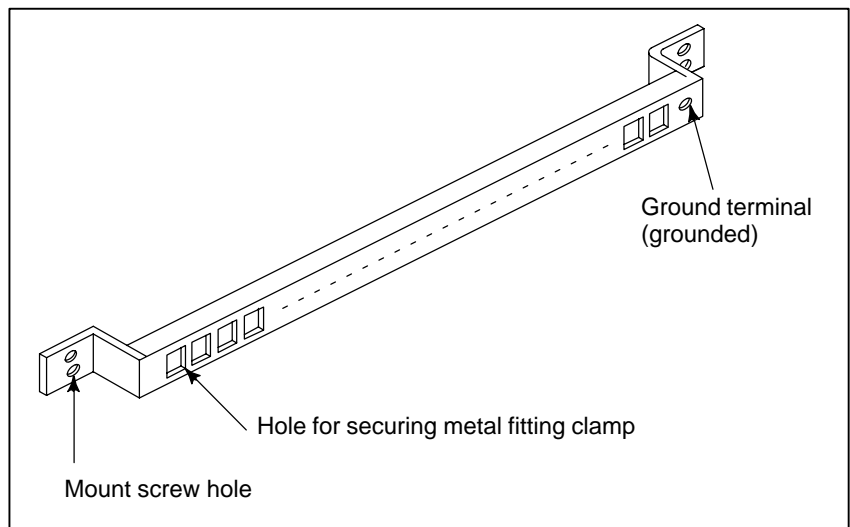

Fig. 2.16.5 (c) Ground plate

For the ground plate, use a metal plate of 2 mm or thicker, which surface is plated with nickel.

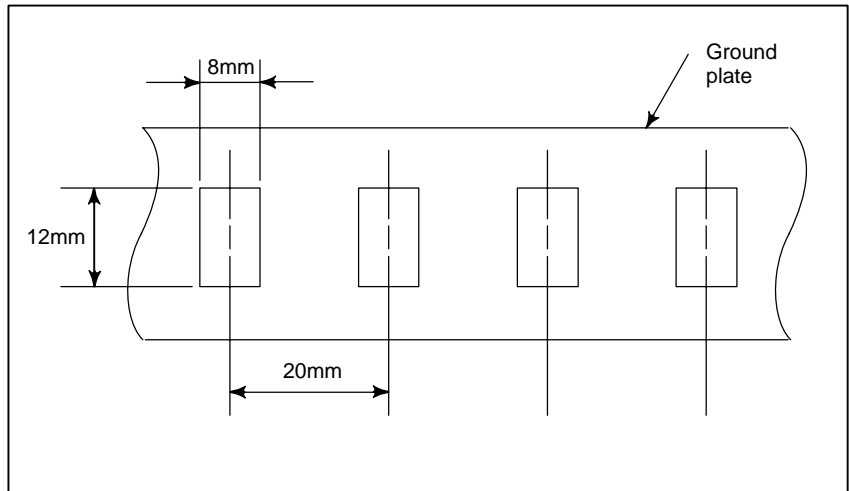

Fig. 2.16.5 (d) Ground plate holes

(Reference) Outer drawings of metal fittings for clamp.

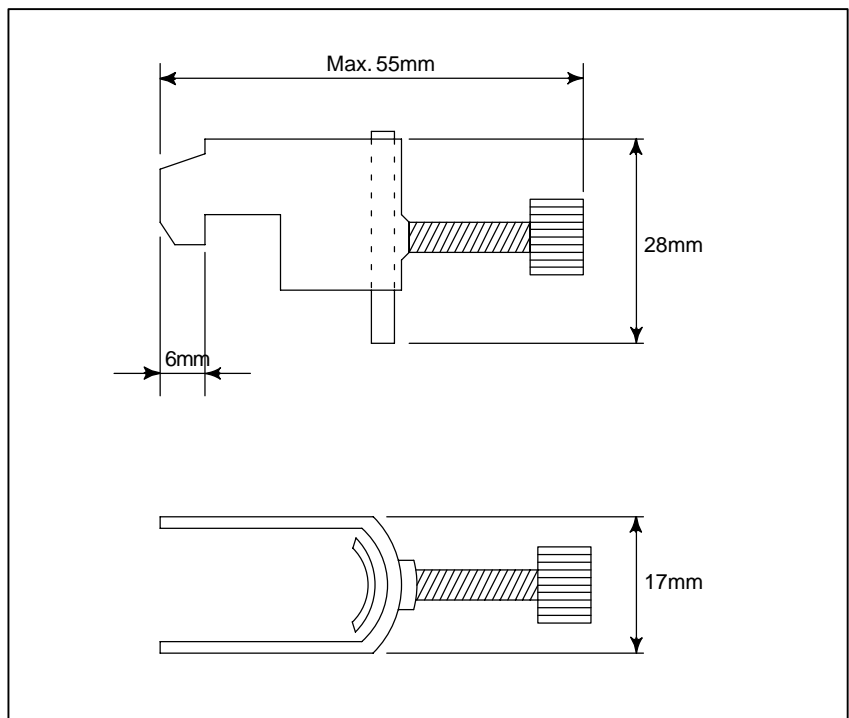

Fig. 2.16.5 (e) Outer drawings of metal fittings for clamp

Ordering specification for metal fittings for clamp
 A02B-0124-K001 (8 pieces)

3

INPUT AND OUTPUT OF DATA







After you change a SRAM module, you must set various data again. This chapter describes the procedures to input and output the parameters, the part programs and the tool offset values.

| | | |
|-----|---|-----|
| 3.1 | SETTING PARAMETERS FOR INPUT/OUTPUT | 249 |
| 3.2 | INPUTTING/OUTPUTTING DATA | 251 |
| 3.3 | DATA INPUT/OUTPUT ON THE ALL IO SCREEN | 260 |
| 3.4 | DATA INPUT/OUTPUT USING A MEMORY CARD | 275 |



3.1 SETTING PARAMETERS FOR INPUT/OUTPUT

● **Setting procedure of parameters**

Parameter writing is enabled with following steps 1 to 3.

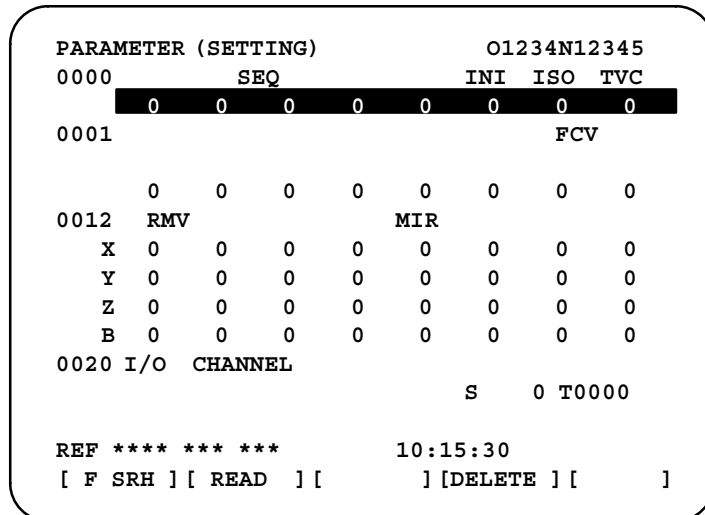
1. Set to MDI mode or emergency stop state.
2. Press  key several times or press soft key [SETTING] to display **SETTING (HANDY)** screen.
3. Set the cursor to **PARAMETER WRITE** and, press  and  keys in this order. Here alarm 100 will be displayed.
4. Press  key several times to display the following screen.



To make the cursor display in bit unit, press the cursor key  or .

5. Press soft key [(OPRT)] and the following operation menu is displayed.
 - 1) Soft key [NO. SRH] : Searched by number. Examination) Parameter number → [NO. SRH].
 - 2) Soft key [ON : 1] : Item with cursor position is set to 1 (bit parameter)
 - 3) Soft key [OFF : 0] : Item with cursor position is set to 0 (bit parameter)
 - 4) Soft key [+INPUT] : Input value is added to the value at cursor (word type)
 - 5) Soft key [INPUT] : Input value is replaced with the value at cursor (word type)
 - 6) Soft key [READ] : Parameters are input from reader/puncher interface.
 - 7) Soft key [PUNCH] : Parameters are output to reader/puncher interface.

6. After the parameters have been input, set **PARAMETER WRITE** on the **SETTING** screen to 0. Press to release alarm 100.

7. Convenient method

1) To change parameters in bit unit, press cursor key or , then the cursor becomes bit length and you can set parameters bit by bit (Bit parameter only).

2) To set data consecutively, use key.

(Ex.1)

This key sequence sets data as follows:

| | | |
|---|------|------|
| 0 | 1234 | |
| 0 | ⇒ | 4567 |
| 0 | | 9999 |
| 0 | | 0 |

(Ex.2)

This key sequence sets data as follows:

| | | |
|---|------|------|
| 0 | 1234 | |
| 0 | ⇒ | 0 |
| 0 | | 9999 |
| 0 | | 0 |

3) To set the same data sequentially, press .

(Ex.)

This key sequence sets data as follows:

| | | |
|---|------|------|
| 0 | 1234 | |
| 0 | ⇒ | 1234 |
| 0 | | 1234 |
| 0 | | 0 |

4) Bit parameters can be set as follows:

(Ex.)

This key sequence sets data as follows:

| | | | | | |
|----------|--------------------------|----------|--------------------------|------|------|
| 000 | <input type="checkbox"/> | 0000 | 000 | 1 | 1000 |
| 00000000 | ⇒ | 000 | 1 | 1000 | |
| 00000000 | | 000 | <input type="checkbox"/> | 1000 | |
| 00000000 | | 00000000 | | | |

8. After the required parameters are set, set **PARAMETER WRITE** to 0.

3.2 INPUTTING/ OUTPUTTING DATA

The main CPU memorized the following data.
 Outputting the data I/O device while the CNC is running normally

- (1) CNC parameter
- (2) PMC parameter
- (3) Pitch error compensation amount
- (4) Custom macro variable values
- (5) Tool compensation amount
- (6) Part program (machining program, custom macro program)

3.2.1 Confirming the Parameters Required for Data Output

Be sure that data output cannot be done in an alarm status.
 Parameters required for output are as follows :
 In addition, ☆ indicates the standard setting for input/output devices made by FANUC. Change these settings according to the unit you actually use.
 (Parameter can be changed in MDI mode or emergency stop status.)

| | | | | | | | | |
|------|----|----|----|----|----|----|-----|----|
| | #7 | #6 | #5 | #4 | #3 | #2 | #1 | #0 |
| 0000 | | | | | | | ISO | |

- #1 (ISO) 0 : Output with EIA code
 1 : Output with ISO code (FANUC cassette)

| | |
|------|--------------------------|
| 0020 | Selection of I/O channel |
|------|--------------------------|

- ☆ 0 : Channel 1 (JD36A of mother board)
 - 1 : Channel 1 (JD36A of mother board)
 - 2 : Channel 2 (JD36B of mother board)
 - 4 : Memory card interface
 - 5 : Data Server interface
 - 6 : DNC operation or the M198 command is executed with FOCAS1/Ethernet.
- 20 }
 21 } Data input/output is performed via the FANUC I/O Link
 22 } between the CNC and the Power Mate CNC in group n
 | } (where n is from 0 to 15).
 34 }
 35 }

NOTE
 An operation example shown here assumes that data input/output is performed with an input/output unit connected to the JD36A. (I/O channel = 0)

| | | | | | | | | |
|------|-----|----|----|----|-----|----|----|-----|
| | #7 | #6 | #5 | #4 | #3 | #2 | #1 | #0 |
| 0101 | NFD | | | | ASI | | | SB2 |

#7 (NFD) 0 : Feed is output when data is output.

1 : Feed is not output when data is output.

#3 (ASI)☆ 0 : EIA or ISO code is used for input/output data.

1 : ASCII code is used.

#0 (SB2) 0 : No. of stop bits is 1.

☆ 1 : No. of stop bits is 2.





| | |
|------|--|
| 0102 | pecification number of input/output device |
|------|--|

| Set value | Input/output device |
|-----------|---|
| 0 | RS-232-C (Used control codes DC1 to DC4) |
| 1 | FANUC CASSETTE ADAPTOR 1 (FANUC CASSETTE B1/ B2) |
| 2 | FANUC CASSETTE ADAPTOR 3 (FANUC CASSETTE F1) |
| 3 | FANUC Handy File |
| 4 | RS-232-C (Not used control codes DC1 to DC4) |
| 5 | Portable tape reader |
| 6 | FANUC PPR FANUC SYSTEM P-MODEL G, FANUC SYSTEM P-MODEL H |















| | |
|------|-----------|
| 0103 | Baud Rate |
|------|-----------|

- 1: 50 5: 200 9: 2400
- 2: 100 6: 300 ☆10: 4800
- 3: 110 7: 600 11: 9600
- 4: 150 8: 1200 12: 19200 [BPS]



3.2.2 Outputting CNC Parameters

1. Enter **EDIT** mode or the emergency stop condition.
2. Press  key and soft key **[PRGRM]** to select a program text.
3. Press soft key **[(OPRT)]** and soft key .
And then, put out the head of file by pressing **[FSRH]**  **[EXEC]**.
4. Press  key and soft key **[PARAM]** to display parameter screen.
5. Press soft key **[(OPRT)]** ,and soft key .
6. Press soft key **[PUNCH]** and **[EXEC]**,and the parameters are started to be output.

3.2.3 Outputting PMC Parameters



1. Select MDI mode.
2. Press  key then soft key [SETTING] to select a setting screen.
3. Set the cursor to **PARAMETER WRITE** and input  and . At this time, alarm 100 will be generated.
4. Press  key and soft key [PMC].
5. Press soft key [PMCPRM] and then soft key [SETTING] to display a setting screen.
6. On the setting screen, set "PROGRAMMER ENABLE" to "YES" (bit 1 of K900/K17 = 1). Thus, data input/output screen has been selected.
7. Select EDIT mode.
8. Press soft key  then key .
9. Press soft key [I/O] and set the parameters on I/O. Item selection cursor moves to the following item after data of an item is set.
10. In CHANNEL NO item, input   to select I/O channel 1.
11. In DEVICE item, press soft key [FDCAS] to select the floppy cassette.
12. In KIND DATA item, press soft key [PARAM].
13. In FUNCTION item, press soft key [WRITE].
14. In FILE No item, specify a file name. In this example input as follows:
    
15. Press soft key [EXEC]. Then PMC parameters are started to be output.
16. After the PMC parameters have been output, set PARAMETER WRITE to 0.
17. Press  to release alarm 100.

3.2.4 Outputting Pitch Error Compensation Amount



1. Select EDIT mode.
2. Press  key several times, press soft key [PARAM],  and [PITCH] to select the SETTING screen for pitch error amount.
3. Press soft key [(OPRT)] and .
4. Press soft key [PUNCH] and [EXEC], then pitch error compensation amount is started to be output.

3.2.5 Outputting Custom Macro Variable Values

When custom macro function is equipped, values of variable no. 500 and later are output.

1. Press  key.
2. Press  key and soft key **[MACRO]** to select custom macro variable screen.
3. Press soft key **[(OPRT)]** and then key .
4. Press soft key **[PUNCH]** and **[EXEC]**, then custom macro variable values are output.

3.2.6 Outputting Tool Compensation Amount

1. Select EDIT mode.
2. Press  key and soft key **[OFFSET]** to display the tool compensation amount screen.
3. Press **[(OPRT)]** key and soft key .
4. Press soft key **[PUNCH]** an **[EXEC]** key, and the tool compensation amount is started to be output.

3.2.7 Outputting Part Program

1. Confirm the following parameters. If this parameter is set to 1, rather than the value indicated by ☆, change to MDI mode and then reset to 0. However, if you changed the parameter setting, restore the original value after finishing this work.

| | #7 | #6 | #5 | #4 | #3 | #2 | #1 | #0 |
|------|----|----|----|-----|----|----|----|-----|
| 3202 | | | | NE9 | | | | NE8 |

#4 (NE9) ☆ 0 : Programs of 9000s are edited.

1 : Programs of 9000s can be protected.

#0 (NE8) ☆ 0 : Programs of 8000s are edited.

1 : Programs of 8000s can be protected.

2. Select EDIT mode.

3. Press  key and press soft key **[PRGRM]** to display program text.

4. Press **[(OPRT)]** key and press soft key .



5. Input a program number to be output. To output all programs input as:

6. Press **[PUNCH]** and **[EXEC]** key, then program output is started.

3.2.8 Inputting CNC Parameters

1. Set to the emergency stop state.
2. Confirm that the parameters required to input data is correct.
In addition, ☆ indicates the standard setting for input/output devices made by FANUC. Change these settings according to the unit you actually use.

- 1) Press  key several times, and press [SETTING] to display SETTING screen.
- 2) Confirm that PARAMETER WRITE=1.
- 3) Press  key to select the parameter screen.
- 4)

| | |
|------|--------------------------|
| 0020 | Selection of I/O channel |
|------|--------------------------|

- ☆ 0 : Channel 1 (JD36A of mother board)
- 1 : Channel 1 (JD36A of mother board)
- 2 : Channel 2 (JD36B of mother board)
- 5)

| | | | | | | | | |
|------|-----|----|----|----|-----|----|----|-----|
| 0101 | #7 | #6 | #5 | #4 | #3 | #2 | #1 | #0 |
| | NFD | | | | ASI | | | SB2 |

- #7 (NFD)** 0 : Feed is output when punching out.
1 : Feed is not output when punching out.
- #3 (ASI)** 0 : EIA or ISO code is used.
1 : ASCII code is used.
- #0 (SB2)** 0 : No. of stop bits is 1.
☆ 1 : No. of stop bits is 2.

6)

| | |
|------|------------------------------------|
| 0102 | Specification number of I/O device |
|------|------------------------------------|

| Set value | Input/output device |
|-----------|---|
| 0 | RS-232-C (Used control codes DC1 to DC4) |
| 1 | FANUC CASSETTE ADAPTOR 1 (FANUC CASSETTE B1/ B2) |
| 2 | FANUC CASSETTE ADAPTOR 3 (FANUC CASSETTE F1) |
| 3 | FANUC Handy File |
| 4 | RS-232-C (Not used control codes DC1 to DC4) |
| 5 | Portable tape reader |
| 6 | FANUC PPR FANUC SYSTEM P-MODEL G, FANUC SYSTEM P-MODEL H |

7)

| | |
|------|-----------|
| 0103 | Baud rate |
|------|-----------|









1: 50 5: 200 9: 2400
 2: 100 6: 300 ☆10: 4800
 3: 110 7: 600 11: 9600
 4: 150 8: 1200 12: 19200 [BPS]

3. Press soft key 
4. Press soft key **[READ]** and **[EXEC]**. Then input of parameters are started.
5. Because alarm 300 will generate for the system with absolute pulse coder, set parameter 1815#5 to 0.
6. Alarm 300 is issued if the system employs an absolute pulse coder. In such a case, perform reference position return again.







3.2.9 Inputting PMC Parameters

Set the emergency stop state.









※ Operation of 12 is not required when PPR is used.

1. Turn off (KEY4=1) the program protect key.
2. Press  key and soft key **[SETTING]** to select the SETTING screen.
3. Confirm that PARAMETER WRITE=1.
4. Press  key and soft key **[PMC]**.
5. Press soft key **[PMCPRM]** and then soft key **[SETTING]** to display a setting screen.
6. On the setting screen, set "PROGRAMMER ENABLE" to "YES" (bit 1 of K900/K17 = 1).
Thus, data input/output screen has been selected.
7. Press  key and  key.
8. Press soft key **[I/O]** and set the parameters required for I/O.
Item selection cursor displays the next item after an item is set.
9. In CHANNEL item, press   to select channel 1.
10. In DEVICE item, press **[FDCAS]** key to select the floppy cassette.
11. In FUNCTION item, press soft key **[READ]** to input data
12. In FILE NO item, press   to select file no. 2.
13. Press soft key **[EXEC]** and the PMC parameters are started to be input.
14. After data has been read, turn off power and turn it on.

3.2.10 Inputting Pitch Error Compensation Amount

1. Release the emergency stop and select EDIT mode.
2. Confirm that PARAMETER WRITE=1 on the setting screen.
3. Press  key and soft key **[PRGRM]** to display program contents.
4. Press soft key **[(OPRT)]**, , **[F SRH]**, and  **[EXEC]** to select the pitch error compensation file.
5. Press  key several times, soft key **[PARAM]**,  and **[PITCH]** to select the screen for pitch error compensation amount.
6. Press soft key **[(OPRT)]** and  key.
7. Press soft key **[READ]** and **[EXEC]**, then the pitch error compensation amount is started to be input.
8. After data has been input, press  key twice to display the SETTING screen and return the PARAMETER WRITE to 0.

3.2.11 Inputting Custom Macro Variable Values

- * If the system is equipped with the custom macro function, input the variable values.
 - * For PPR, item 4 is not required.
1. Confirm that EDIT mode is selected.
 2. Turn off the program protect key (KEY2=1).
 3. Press  key then soft key **[PRGRM]** to display program contents.
 4. Press soft key **[(OPRT)]**, , **[F SRH]**, and  **[EXEC]** to select a file.
 5. Press soft key **[(OPRT)]** and key .
 6. Press address , a program number (0001 for example), soft key **[READ]** and **[EXEC]** key, then custom macro variable values are started to be input.
Input a program number that is not used.
 7. Select MEMORY mode on the machine operator's panel and press cycle start button.
When the program is executed, macro variables are set.
 8. Press  key,  key and soft key **[MACRO]** to select the custom macro variable screen.
 9. Press 500 and soft key **[NO SRH]** to display variable number 500 and confirm the custom macro variables are set correctly.
 - * Of the data displayed, 0 and vacant differ in meaning.
Vacant is an undefined variable. To set vacant, press soft key **[INPUT]**.
 10. Select EDIT mode again.
 11. Press  key to select the program display screen.

12. Press address O and a program number (0001 for example), then press



to delete the program.

3.2.12 Inputting Tool Compensation Amount

Item 4 is not required for PPR.

1. Select the EDIT mode.
2. Turn off the program protect (KEY=1).
3. Press key, and press soft key [PRGRM] to display the program contents screen.
4. Press soft key [(OPRT)], , [F SRH], and [EXEC] to select the tool compensation amount file.
5. Press key, and soft key [OFFSET] to display the tool compensation amount screen.
6. Press soft key [(OPRT)] and key.
7. Press [READ] key and [EXEC] key and data input is started.

3.2.13 Inputting Part Programs

Confirm the following parameters. If the setting is different from the value indicated by ☆, reset to the specified value only during this work. (Change it in MDI mode).

| | #7 | #6 | #5 | #4 | #3 | #2 | #1 | #0 |
|------|----|-----|----|----|----|----|-----|----|
| 3201 | | NPE | | | | | RAL | |

#6 (NPE) When programs are registered in part program storage area, M02,M30 and M99 are:

0 : Regarded as the end of program.

☆ 1 : Not regarded as the end of program.

#1 (RAL) When programs are registered:

☆ 0 : All programs are registered.

1 : Only one program is registered.

| | #7 | #6 | #5 | #4 | #3 | #2 | #1 | #0 |
|------|----|----|----|-----|----|----|----|-----|
| 3202 | | | | NE9 | | | | NE8 |

#4 (NE9)

☆ 0 : Programs of 9000s can be edited.





1 : Programs of 9000s are protected.

#0 (NE8)

☆ 0 : Programs of 8000s can be edited.

1 : Programs of 8000s are protected.

※ For PPR, item 4 is not required.

1. Confirm that mode is EDIT mode.
2. Turn off the program protect (KEY3=1).
3. Press  key and press soft key [**PRGRM**] to select a part program file.
4. Press soft key [(**OPRT**)],  [**F SRH**], and  [**EXEC**] to select a part program file.
5. Press soft  key ,[(**OPRT**)] and  key.
6. Press soft key [**READ**] and [**EXEC**], then data input is started.

3.3 DATA INPUT/OUTPUT ON THE ALL IO SCREEN

To input/output a particular type of data, the corresponding screen is usually selected. For example, the parameter screen is used for parameter input from or output to an external input/output unit, while the program screen is used for program input or output. However, programs, parameters, offset data, and macro variables can all be input and output using a single common screen, that is, the ALL IO screen.

| READ/PUNCH (PROGRAM) | | O1234 N12345 | |
|---|----------------|------------------|------------|
| I/O CHANNEL | 1 | TV CHECK | OFF |
| DEVICE NUM. | 0 | PUNCH CODE | ISO |
| BAUDRATE | 4800 | INPUT CODE | ASCII |
| STOP BIT | 2 | FEED OUTPUT | FEED |
| NULL INPUT (EIA) | NO | EOB OUTPUT (ISO) | CR |
| TV CHECK (NOTES) | ON | | |
| (0:EIA 1:ISO)>1_ | | | |
| MDI | **** * * * * * | | 12:34:56 |
| 〔 PRGRM 〕〔 PARAM 〕〔 OFFSET 〕〔 MACRO 〕〔 (OPRT) 〕 | | | |



Fig. 3.3 ALL IO screen (when channel 1 is being used for input/output)

3.3.1 Setting Input/Output-Related Parameters

Input/output-related parameters can be set on the ALL IO screen. Parameters can be set, regardless of the mode.

Setting input/output-related parameters

Procedure

- 1 Press function key  .
- 2 Press the rightmost soft key  (continuous menu key) several times.
- 3 Press soft key **[ALL IO]** to display the ALL IO screen.

NOTE

- 1 If program or floppy is selected in EDIT mode, the program directory or floppy screen is displayed.
- 2 When the power is first turned on, program is selected by default.

```

READ/PUNCH (PROGRAM)                O1234 N12345
I/O CHANNEL          1          TV CHECK      OFF
DEVICE NUM.          0          PUNCH CODE    ISO
BAUDRATE             4800       INPUT CODE    ASCII
STOP BIT             2          FEED OUTPUT   FEED
NULL INPUT (EIA)     NO        EOB OUTPUT (ISO) CR
TV CHECK (NOTES)     ON

```

(0:EIA 1:ISO)>1_

MDI **** * * * * * 12:34:56

{ PRGRM } { PARAM } { OFFSET } { MACRO } { (OPRT) }

- 4 Select the soft key corresponding to the desired type of data (program, parameter, and so forth).
- 5 Set the parameters corresponding to the type of input/output unit to be used. (Parameter setting is possible regardless of the mode.)

Tip

First, set an I/O channel. The parameters on this screen change to those corresponding to a specified I/O channel.

- I/O channel (0 to 2)

| Setting | Corresponding parameter |
|---------|-------------------------|
| 0 | No. 101 to 103 |
| 1 | No. 111 to 113 |
| 2 | No. 121 to 123 |

- Device number

| Setting | Input/output device |
|---------|---|
| 0 | RS-232-C (The control codes DC1 through DC4 are used.) |
| 1 | FANUC CASSETTE ADAPTOR 1 (FANUC CASSETTE B1/B2) |
| 2 | FANUC CASSETTE ADAPTOR 3 (FANUC CASSETTE F1) |
| 3 | FANUC Handy File |
| 4 | RS-232-C (The control codes DC1 through DC4 are not used.) |
| 5 | Portable tape reader |
| 6 | FANUC PPR FANUC SYSTEM P-MODEL G, FANUC SYSTEM P-MODEL H |

- Baud rate (bps)

Set a desired baud rate value indicated below.

| Baud rate (bps) |
|-----------------|
| 50 |
| 100 |
| 110 |
| 150 |
| 200 |
| 300 |
| 600 |
| 1200 |
| 2400 |
| 4800 |
| 9600 |
| 19200 |

3.3.2 Inputting and Outputting Programs

A program can be input and output using the ALL IO screen.
When entering a program using a cassette or card, the user must specify the input file containing the program (file search).

File search

Procedure

- 1 Press soft key **[PRGRM]** on the ALL IO screen, described in Section 3.3.1.
- 2 Select **EDIT** mode. A program directory is displayed.
- 3 Press soft key **[(OPRT)]**. The screen and soft keys change as shown below.
 - A program directory is displayed only in EDIT mode. In all other modes, the ALL IO screen is displayed.

```

                                O0001 N00010
                                PROGRAM (NUM.)    MEMORY (CHAR.)
                                USED   :    60      3321
                                FREE   :     2      429

                                O0010 O0001 O0003 O0002 O0555 O0999
                                O0062 O0004 O0005 O1111 O0969 O6666
                                O0021 O1234 O0588 O0020 O0040

                                >_
                                EDIT  ****  ***  ***  ***
                                14:46:09
                                ( F SRH ) ( READ ) ( PUNCH ) ( DELETE ) ( (OPRT) )

```

- 4 Enter address N.
- 5 Enter the number of the file to be found.
 - N0
The first floppy file is found.
 - One of N1 to N9999
Among the files numbered from 1 to 9999, a specified file is found.
 - N-9999
The file immediately after that used most recently is found.
 - N-9998
When -9998 is specified, the next file is found. Then, each time a file input/output operation is performed, N-9999 is automatically inserted. This means that subsequent files can be sequentially found automatically.
This state is canceled by specifying N0, N1 to N9999, or N-9999, or upon a reset.
- 6 Press soft keys **[F SRH]** and **[EXEC]**.
The specified file is found.

(<) (<) (<) (<) (CAN) (EXEC)

Inputting a program

Procedure

- 1 Press soft key **[PRGRM]** on the ALL IO screen, described in Section 3.3.1.
- 2 Select EDIT mode. A program directory is displayed.
- 3 Press soft key **[(OPRT)]**. The screen and soft keys change as shown below.
 - A program directory is displayed only in EDIT mode. In all other modes, the ALL IO screen is displayed.

```

                                O0001 N00010
                                PROGRAM (NUM.)  MEMORY (CHAR.)
                                USED :    60      3321
                                FREE :     2      429

                                O0010 O0001 O0003 O0002 O0555 O0999
                                O0062 O0004 O0005 O1111 O0969 O6666
                                O0021 O1234 O0588 O0020 O0040

                                >_
                                EDIT **** * * * * *                14:46:09
                                { F SRH } { READ } { PUNCH } { DELETE } { (OPRT) }

```

- 4 To specify a program number to be assigned to an input program, enter address O, followed by the desired program number. If no program number is specified, the program number in the file or on the NC tape is assigned as is.
- 5 Press soft key **[READ]**, then **[EXEC]**. The program is input with the program number specified in step 4 assigned. To cancel input, press soft key **[CAN]**. To stop input prior to its completion, press soft key **[STOP]**.

{ } { } {STOP} {CAN} {EXEC}

Outputting programs

Procedure

- 1 Press soft key **[PRGRM]** on the ALL IO screen, described in Section 3.3.1.
- 2 Select EDIT mode. A program directory is displayed.
- 3 Press soft key **[(OPRT)]**. The screen and soft keys change as shown below.
 - A program directory is displayed only in EDIT mode. In all other modes, the ALL IO screen is displayed.

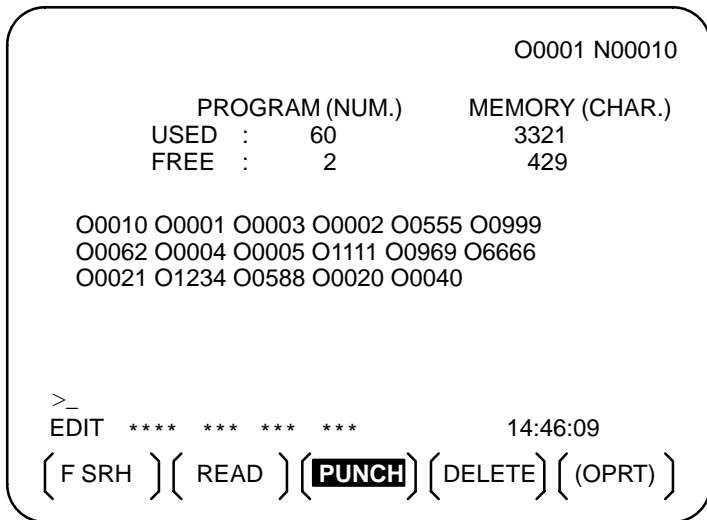

- 4 Enter address O.
- 5 Enter a desired program number.

If -9999 is entered, all programs in memory are output.

To output a range of programs, enter OΔΔΔΔ, O□□□□. The programs numbered from ΔΔΔΔ to □□□□ are output.

When bit 4 (SOR) of parameter No. 3107 for sorted display is set to 1 on the program library screen, programs are output in order, starting from those having the smallest program numbers.
- 6 Press soft key **[PUNCH]**, then **[EXEC]**.

The specified program or programs are output. If steps 4 and 5 are omitted, the currently selected program is output.

To cancel output, press soft key **[CAN]**.

To stop output prior to its completion, press soft key **[STOP]**.

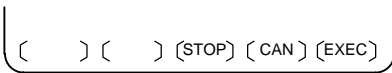

Deleting files

Procedure

- 1 Press soft key **[PRGRM]** on the ALL IO screen, described in Section 3.3.1.
- 2 Select EDIT mode. A program directory is displayed.
- 3 Press soft key **[(OPRT)]**. The screen and soft keys change as shown below.
 - A program directory is displayed only in EDIT mode. In all other modes, the ALL IO screen is displayed.

```

                                O0001 N00010
                                PROGRAM (NUM.)   MEMORY (CHAR.)
                                USED  :    60      3321
                                FREE  :     2      429

                                O0010 O0001 O0003 O0002 O0555 O0999
                                O0062 O0004 O0005 O1111 O0969 O6666
                                O0021 O1234 O0588 O0020 O0040

                                >_
                                EDIT  ****  ***  ***  ***          14:46:09
                                ( F SRH ) ( READ ) ( PUNCH ) ( DELETE ) ( (OPRT) )
```

- 4 Press soft key **[DELETE]**.
- 5 Enter a file number, from 1 to 9999, to indicate the file to be deleted.
- 6 Press soft key **[EXEC]**.
The k-th file, specified in step 5, is deleted.

```

(      ) (      ) (      ) (CAN) (EXEC)
```

3.3.3 Inputting and Outputting Parameters

Parameters can be input and output using the ALL IO screen.

Inputting parameters

Procedure

- 1 Press soft key **[PARAM]** on the ALL IO screen, described in Section 3.3.1.
- 2 Select EDIT mode.
- 3 Press soft key **[(OPRT)]**. Soft keys change as shown below.

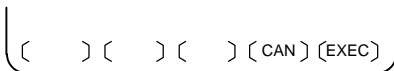

- 4 Press soft key **[READ]**, then **[EXEC]**.
The parameters are read, and the “INPUT” indicator blinks at the lower-right corner of the screen. Upon the completion of input, the “INPUT” indicator is cleared from the screen.
To cancel input, press soft key **[CAN]**.

Outputting parameters

Procedure

- 1 Press soft key **[PARAM]** on the ALL IO screen, described in Section 3.3.1.
- 2 Select EDIT mode.
- 3 Press soft key **[(OPRT)]**. Soft keys change as shown below.

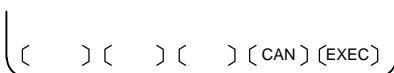

- 4 Press soft key **[PUNCH]**, then **[EXEC]**.
The parameters are output, and the “OUTPUT” indicator blinks at the lower-right corner of the screen. Upon the completion of output, the “OUTPUT” indicator is cleared from the screen.
To cancel output, press soft key **[CAN]**.

3.3.4 Inputting and Outputting Offset Data

Offset data can be input and output using the ALL IO screen.

Inputting offset data

Procedure

- 1 Press soft key [**OFFSET**] on the ALL IO screen, described in Section 3.3.1.
- 2 Select EDIT mode.
- 3 Press soft key [**(OPRT)**]. Soft keys change as shown below.

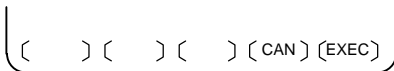
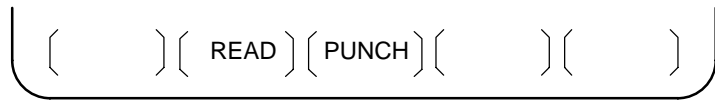

- 4 Press soft key [**READ**], then [**EXEC**].
The offset data is read, and the “INPUT” indicator blinks at the lower-right corner of the screen.
Upon the completion of input, the “INPUT” indicator is cleared from the screen.
To cancel input, press soft key [**CAN**].

Outputting offset data

Procedure

- 1 Press soft key [**OFFSET**] on the ALL IO screen, described in Section 3.3.1.
- 2 Select EDIT mode.
- 3 Press soft key [**(OPRT)**]. Soft keys change as shown below.

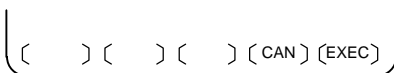

- 4 Press soft key [**PUNCH**], then [**EXEC**].
The offset data is output, and the “OUTPUT” indicator blinks at the lower-right corner of the screen. Upon the completion of output, the “OUTPUT” indicator is cleared from the screen.
To cancel output, press soft key [**CAN**].

3.3.5 Outputting Custom Macro Common Variables

Custom macro common variables can be output using the ALL IO screen.

Outputting custom macro common variables

Procedure

- 1 Press soft key **[MACRO]** on the ALL IO screen, described in Section 3.3.1.
- 2 Select EDIT mode.
- 3 Press soft key **[(OPRT)]**. Soft keys change as shown below.

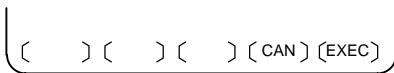

- 4 Press soft key **[PUNCH]**, then **[EXEC]**.
The custom macro common variables are output, and the “OUTPUT” indicator blinks at the lower-right corner of the screen. Upon the completion of output, the “OUTPUT” indicator is cleared from the screen.
To cancel output, press soft key **[CAN]**.

NOTE

To input a macro variable, read the desired custom macro statement as a program, then execute the program.

3.3.6 Inputting and Outputting Floppy Files

The ALL IO screen supports the display of a directory of floppy files, as well as the input and output of floppy files.

Displaying a file directory

Procedure

- 1 Press the rightmost soft key  (continuous menu key) on the ALL IO screen, described in Section 3.3.1.
- 2 Press soft key **[FLOPPY]**.
- 3 Select EDIT mode. The floppy screen is displayed.
- 4 Press soft key **[(OPRT)]**. The screen and soft keys change as shown below.
 - The floppy screen is displayed only in EDIT mode. In all other modes, the ALL IO screen is displayed.

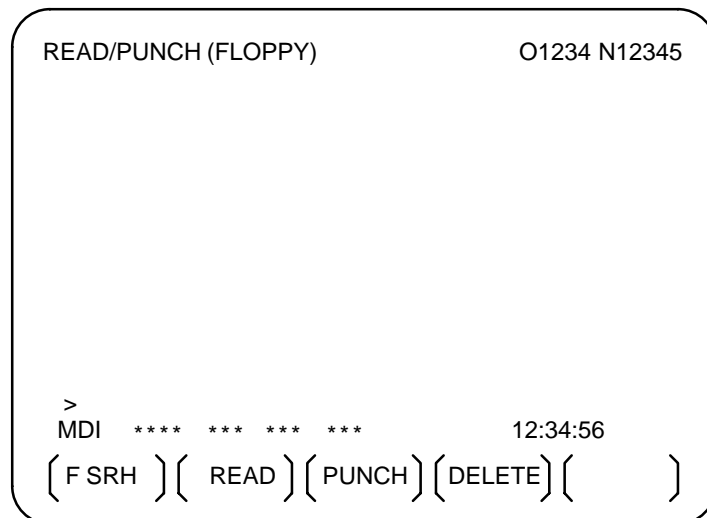

- 5 Press soft key **[F SRH]**.
- 6 Enter the number of the desired file, then press soft key **[F SET]**.
- 7 Press soft key **[EXEC]**. A directory is displayed, with the specified file uppermost. Subsequent files in the directory can be displayed by pressing the page key.

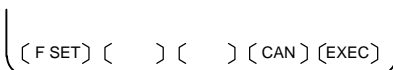

| READ/PUNCH (FLOPPY) | | O1234 N12345 |
|---------------------|-------------|--------------|
| No. | FILE NAME | (Meter) VOL |
| 0001 | PARAMETER | 46.1 |
| 0002 | ALL.PROGRAM | 12.3 |
| 0003 | O0001 | 1.9 |
| 0004 | O0002 | 1.9 |
| 0005 | O0003 | 1.9 |
| 0006 | O0004 | 1.9 |
| 0007 | O0005 | 1.9 |
| 0008 | O0010 | 1.9 |
| 0009 | O0020 | 1.9 |
| F SRH | | |
| File No.=2 | | |
| >2_ | | |
| EDIT | **** ** | 12:34:56 |
| { F SRH } | { } | { CAN } |
| { } | { } | { EXEC } |

A directory in which the first file is uppermost can be displayed simply by pressing the page key. (Soft key **[F SRH]** need not be pressed.)

Inputting a file

Procedure

- 1 Press the rightmost soft key  (continuous menu key) on the ALL IO screen, described in Section 3.3.1.
- 2 Press soft key **[FLOPPY]**.
- 3 Select EDIT mode. The floppy screen is displayed.
- 4 Press soft key **[(OPRT)]**. The screen and soft keys change as shown below.
The floppy screen is displayed only in EDIT mode. In all other modes, the ALL IO screen is displayed.

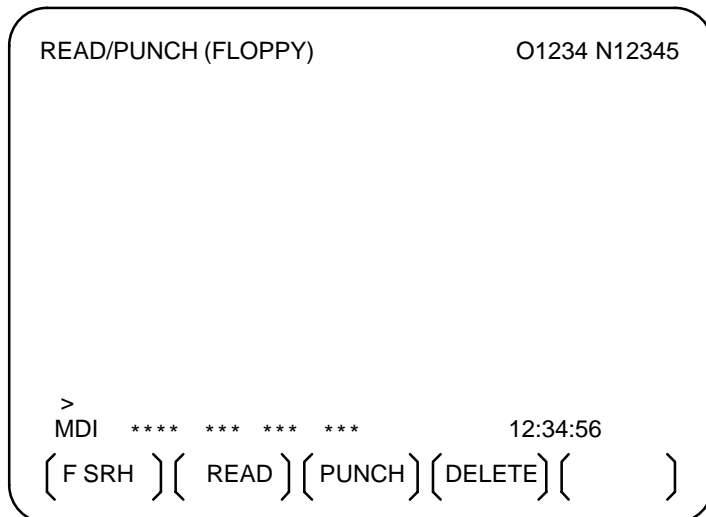

- 5 Press soft key **[READ]**.
- 6 Enter the number of a file or program to be input.
 - Setting a file number: Enter the number of the desired file, then press soft key **[F SET]**.
 - Setting a program number: Enter the number of the desired program, then press soft key **[O SET]**.
- 7 Press soft key **[EXEC]**.
The specified file or program is read, and the “INPUT” indicator blinks at the lower-right corner of the screen. Upon the completion of input, the “INPUT” indicator is cleared from the screen.

Outputting a file

Procedure

- 1 Press the rightmost soft key  (continuous menu key) on the ALL IO screen, described in Section 3.3.1.
- 2 Press soft key **[FLOPPY]**.
- 3 Select EDIT mode. The floppy screen is displayed.
- 4 Press soft key **[(OPRT)]**. The screen and soft keys change as shown below.
The floppy screen is displayed only in EDIT mode. In all other modes, the ALL IO screen is displayed.

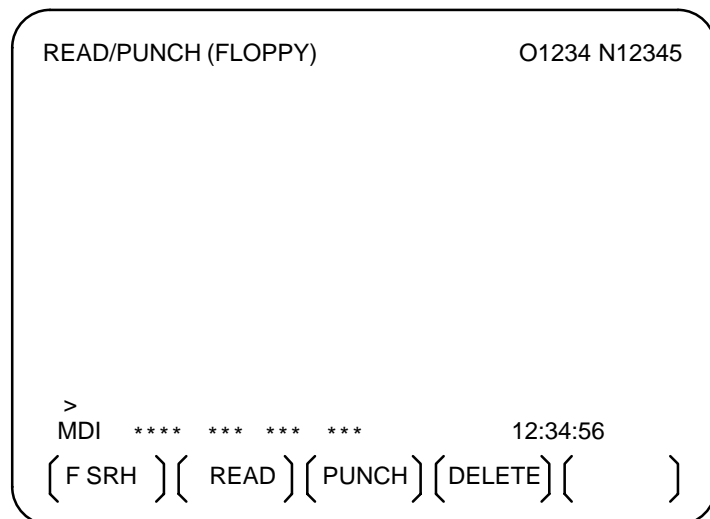

- 5 Press soft key **[PUNCH]**.
- 6 Enter the number of the program to be output, together with a desired output file number.
 - Setting a file number: Enter the number of the desired file, then press soft key **[F SET]**.
 - Setting a program number: Enter the number of the desired program, then press soft key **[O SET]**.
- 7 Press soft key **[EXEC]**.
The specified program is output, and the “OUTPUT” indicator blinks at the lower-right corner of the screen. Upon the completion of output, the “OUTPUT” indicator is cleared from the screen.
If no file number is specified, the program is written at the end of the currently registered files.

Deleting a file

Procedure

- 1 Press the rightmost soft key  (continuous menu key) on the ALL IO screen, described in Section 3.3.1.
- 2 Press soft key **[FLOPPY]**.
- 3 Select EDIT mode. The floppy screen is displayed.
- 4 Press soft key **[(OPRT)]**. The screen and soft keys change as shown below.
The floppy screen is displayed only in EDIT mode. In all other modes, the ALL IO screen is displayed.

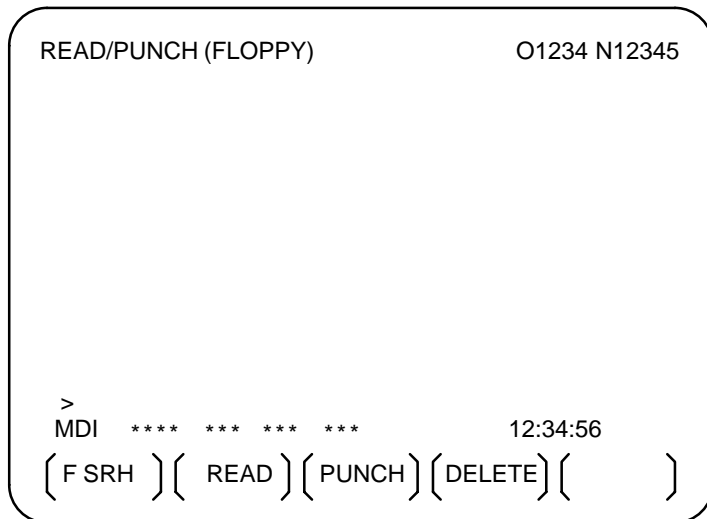

- 5 Press soft key **[DELETE]**.
- 6 Enter the number of the desired file, then press soft key **[F SET]**.
- 7 Press soft key **[EXEC]**. The specified file is deleted. After the file has been deleted, the subsequent files are shifted up.

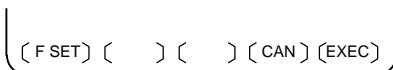

3.4 DATA INPUT/OUTPUT USING A MEMORY CARD

If the I/O channel (parameter No. 20) is set to 4, files on the memory card can be referenced and various types of data such as part programs, parameters, and offset data can be input and output in text file format by using the memory card interface of the control unit.

The major functions are listed below.

- Displaying a directory of stored files
The files stored on a memory card can be displayed on the directory screen.
- Searching for a file
A search is made for a file on a memory card and, if found, it is displayed on the directory screen.
- Reading a file
Text-format files can be read from a memory card.
- Writing a file
Data such as part programs can be stored to a memory card in text file format.
- Deleting a file
A file can be selected and deleted from a memory card.

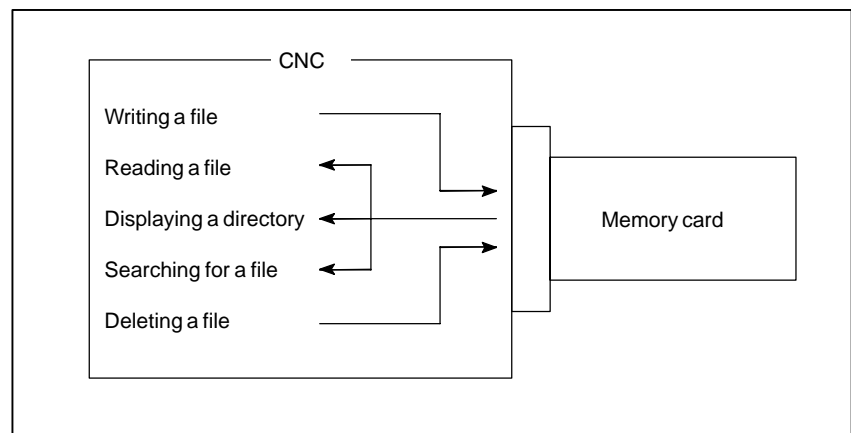

NOTE

When using the program stored on a memory card to make a subprogram call for RMT mode operation (DNC operation) or the M198 command, use the special retainer for securing a memory card to the CNC.

If an attempt is made to write parameters or NC programs to an existing file on the memory card, the OWM parameter (bit 6 of parameter No. 0138) can be used to specify whether to display an overwriting confirmation message. If $OWM = 1$, overwriting is done with no confirmation message displayed.



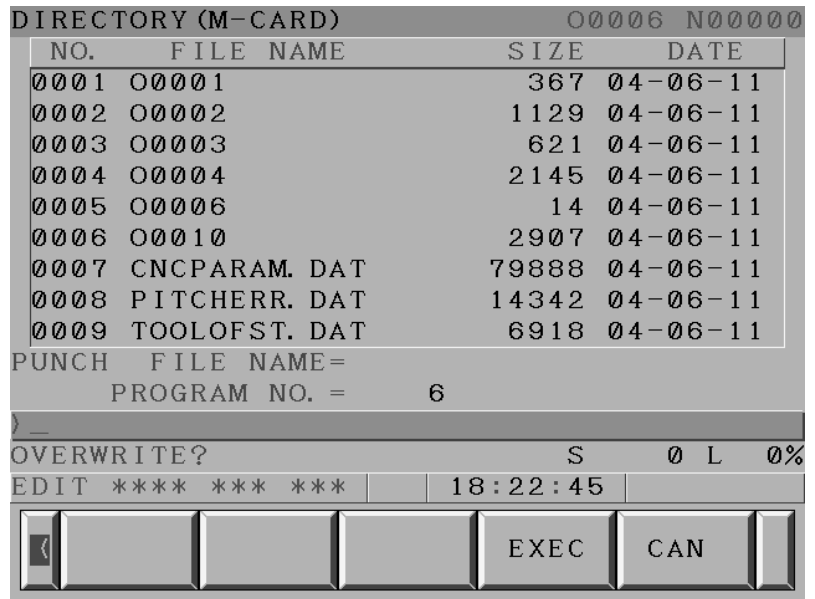

When you press the **[EXEC]** soft key after the **[PUNCH]** soft key, the confirmation message shown below appears on the lower left corner of the screen, if the memory card already contains a file by the same name as specified.



- To overwrite, press the **[EXEC]** soft key again.
- To avoid overwriting, press the **[CANCEL]** soft key, the “<” soft key on the left, or the reset button. It is impossible to go to any other screen if this message is displayed.
- No confirmation message is displayed for any output file name selected from the screen hard copy function, the maintenance information screen, or the PMC screen.

Displaying a directory of stored files

Procedure

- 1 Press the EDIT switch on the machine operator's panel.
- 2 Press function key  .
- 3 Press the rightmost soft key  (continuous menu key).
- 4 Press soft key **[CARD]**. The screen shown below is displayed. Using page keys  and , the screen can be scrolled.

| DIRECTORY (M-CARD) | | | O0034 N00045 |
|--------------------|-----------|--------|--------------|
| No. | FILE NAME | SIZE | DATE |
| 0001 | O1000 | 123456 | 01/07/10 |
| 0002 | O1001 | 8458 | 01/07/30 |
| 0003 | O0002 | 3250 | 01/07/30 |
| 0004 | O2000 | 73456 | 01/07/31 |
| 0005 | O2001 | 3444 | 01/07/31 |
| 0006 | O3001 | 8483 | 01/08/02 |
| 0007 | O3300 | 406 | 01/08/05 |
| 0008 | O3400 | 2420 | 01/07/31 |
| 0009 | O3500 | 7460 | 01/07/31 |

~ ([PROG] ([] ([DIR +] ([] ([(OPRT)]))))) ~

- 5 Comments relating to each file can be displayed by pressing soft key **[DIR+]**.



| DIRECTORY (M-CARD) | | | O0034 N00045 |
|--------------------|-----------|--|----------------|
| No. | FILE NAME | | COMMENT |
| 0001 | O1000 | | (COMMENT) |
| 0002 | O1001 | | (SUB PROGRAM) |
| 0003 | O0002 | | (12345678) |
| 0004 | O2000 | | () |
| 0005 | O2001 | | () |
| 0006 | O3001 | | (SKIP-K) |
| 0007 | O3300 | | (HI-SPEED) |
| 0008 | O3400 | | () |
| 0009 | O3500 | | (TEST PROGRAM) |

~ ([PROG] ([] ([DIR +] ([] ([(OPRT)]))))) ~

- 6 Repeatedly pressing soft key **[DIR+]** toggles the screen between the display of comments and the display of sizes and dates. Any comment described after the O number in the file is displayed. Up to 18 characters can be displayed on the screen.

Searching for a file

Procedure

- 1 Press the EDIT switch on the machine operator's panel.
- 2 Press function key  .
- 3 Press the rightmost soft key  (continuous menu key).
- 4 Press soft key **[CARD]**. The screen shown below is displayed.

| DIRECTORY (M-CARD) | | | O0034 N00045 |
|--------------------|-----------|--------|--------------|
| No. | FILE NAME | SIZE | DATE |
| 0001 | O1000 | 123456 | 01/07/10 |
| 0002 | O1001 | 8458 | 01/07/30 |
| 0003 | O0002 | 3250 | 01/07/30 |
| 0004 | O2000 | 73456 | 01/07/31 |
| 0005 | O2001 | 3444 | 01/07/31 |
| 0006 | O3001 | 8483 | 01/08/02 |
| 0007 | O3300 | 406 | 01/08/05 |
| 0008 | O3400 | 2420 | 01/07/31 |
| 0009 | O3500 | 7460 | 01/07/31 |

~ ([PROG]) ([DIR +]) ([(OPRT)]) ~

- 5 Press soft key **[(OPRT)]**.
- 6 Set the number of the desired file number with soft key **[F SRH]**. Then, start the search by pressing soft key **[EXEC]**. If found, the file is displayed at the top of the directory screen.

([F SRH]) ([F READ]) ([N READ]) ([PUNCH]) ([DELETE])



When a search is made for file number 19

| DIRECTORY (M-CARD) | | O0034 N00045 |
|--------------------|-----------|----------------|
| No. | FILE NAME | COMMENT |
| 0019 | O1000 | (MAIN PROGRAM) |
| 0020 | O1010 | (SUBPROGRAM-1) |
| 0021 | O1020 | (COMMENT) |
| 0022 | O1030 | (COMMENT) |

~ ~

Reading a file

Procedure

- 1 Press the EDIT switch on the machine operator's panel.
- 2 Press function key  .
- 3 Press the rightmost soft key  (continuous menu key).
- 4 Press soft key **[CARD]**. Then, the screen shown below is displayed.

| DIRECTORY (M-CARD) | | | O0034 N00045 |
|--------------------|-----------|--------|--------------|
| No. | FILE NAME | SIZE | DATE |
| 0001 | O1000 | 123456 | 01/07/10 |
| 0002 | O1001 | 8458 | 01/07/30 |
| 0003 | O0002 | 3250 | 01/07/30 |
| 0004 | O2000 | 73456 | 01/07/31 |
| 0005 | O2001 | 3444 | 01/07/31 |
| 0006 | O3001 | 8483 | 01/08/02 |
| 0007 | O3300 | 406 | 01/08/05 |
| 0008 | O3400 | 2420 | 01/07/31 |
| 0009 | O3500 | 7460 | 01/07/31 |

~ ([PROG]) ([DIR +]) ([(OPRT)]) ~

([F SRH]) ([F READ]) ([N READ]) ([PUNCH]) ([DELETE])

- 5 Press soft key **[(OPRT)]**.
- 6 To specify a file number, press soft key **[F READ]**. The screen shown below is displayed.

| DIRECTORY (M-CARD) | | O0001 N00010 |
|--------------------|-----------|----------------|
| No. | FILE NAME | COMMENT |
| 0019 | O1000 | (MAIN PROGRAM) |
| 0020 | O1010 | (SUBPROGRAM-1) |
| 0021 | O1030 | (COMMENT) |

READ
FILE NAME=20 PROGRAM No.=120
>
EDIT *** **** * 15:40:21

([F NAME]) ([O SET]) ([STOP]) ([CAN]) ([EXEC])

- 7 Enter file number 20 from the MDI panel, then set the file number by pressing soft key **[F SET]**. Next, enter program number 120, then set the program number by pressing soft key **[O SET]**. Then, press soft key **[EXEC]**.
 - File number 20 is registered as O0120 in the CNC.
 - Set a program number to register a read file with a separate O number. If no program number is set, the O number in the file name column is registered.

- 8 To specify a file with its file name, press soft key **[N READ]** in step 6 above. The screen shown below is displayed.

| DIRECTORY (M-CARD) | | O0001 N00010 |
|--------------------|-----------|-----------------|
| No. | FILE NAME | COMMENT |
| 0012 | O0050 | (MAIN PROGRAM) |
| 0013 | TESTPRO | (SUB PROGRAM-1) |
| 0014 | O0060 | (MACRO PROGRAM) |

READ FILE NAME =TESTPRO
PROGRAM No. =1230

>



EDIT *** **** ** ***** 15:40:21

{ F NAME } { O SET } { STOP } { CAN } { EXEC }

- 9 To register file name TESTPRO as O1230, enter file name TESTPRO from the MDI panel, then set the file name with soft key **[F NAME]**. Next, enter program number 1230, then set the program number with soft key **[O SET]**. Then, press soft key **[EXEC]**.

Writing a file

Procedure

- 1 Press the EDIT switch on the machine operator's panel.
- 2 Press function key  .
- 3 Press the rightmost soft key  (continuous menu key).
- 4 Press soft key **[CARD]**. The screen shown below is displayed.

| DIRECTORY (M-CARD) | | | O0034 N00045 |
|--------------------|-----------|--------|--------------|
| No. | FILE NAME | SIZE | DATE |
| 0001 | O1000 | 123456 | 01/07/10 |
| 0002 | O1001 | 8458 | 01/07/30 |
| 0003 | O0002 | 3250 | 01/07/30 |
| 0004 | O2000 | 73456 | 01/07/31 |
| 0005 | O2001 | 3444 | 01/07/31 |
| 0006 | O3001 | 8483 | 01/08/02 |
| 0007 | O3300 | 406 | 01/08/05 |
| 0008 | O3400 | 2420 | 01/07/31 |
| 0009 | O3500 | 7460 | 01/07/31 |

~ ([PROG]) ([DIR +]) ([(OPRT)]) ~

([F SRH]) ([F READ]) ([N READ]) ([PUNCH]) ([DELETE])

- 5 Press soft key **[(OPRT)]**.
- 6 Press soft key **[PUNCH]**.
- 7 Enter a desired O number from the MDI panel, then set the program number with soft key **[O SET]**.
When soft key **[EXEC]** is pressed after the setting shown below has been made, for example, the file is written under program number O1230.



~ PUNCH FILE NAME =
PROGRAM No. =1230
>
EDIT *** **** * * * * * 15:40:21
([F NAME]) ([O SET]) ([STOP]) ([CAN]) ([EXEC]) ~

- 8 In the same way as for O number setting, enter a desired file name from the MDI panel, then set the file name with soft key **[F SET]**.
When soft key **[EXEC]** is pressed after the setting shown below has been made, for example, the file is written under program number O1230 and file name ABCD12.

~ PUNCH FILE NAME =ABCD12
PROGRAM No. =1230
>
EDIT *** **** * * * * * 15:40:21
([F NAME]) ([O SET]) ([STOP]) ([CAN]) ([EXEC]) ~

Deleting a file

Procedure

- 1 Press the EDIT switch on the machine operator's panel.
- 2 Press function key  .
- 3 Press the rightmost soft key  (continuous menu key).
- 4 Press soft key **[CARD]**. The screen shown below is displayed.

| DIRECTORY (M-CARD) | | | O0034 N00045 |
|--------------------|-----------|--------|--------------|
| No. | FILE NAME | SIZE | DATE |
| 0001 | O1000 | 123456 | 01/07/10 |
| 0002 | O1001 | 8458 | 01/07/30 |
| 0003 | O0002 | 3250 | 01/07/30 |
| 0004 | O2000 | 73456 | 01/07/31 |
| 0005 | O2001 | 3444 | 01/07/31 |
| 0006 | O3001 | 8483 | 01/08/02 |
| 0007 | O3300 | 406 | 01/08/05 |
| 0008 | O3400 | 2420 | 01/07/31 |
| 0009 | O3500 | 7460 | 01/07/31 |

~ ([PROG]) ([DIR +]) ([(OPRT)]) ~

- 5 Press soft key **[(OPRT)]**.
- 6 Set the number of the desired file with soft key **[DELETE]**, then press soft key **[EXEC]**. The file is deleted, and the directory screen is displayed again.

{ (F SRH) (F READ) (N READ) (PUNCH) (DELETE) }

When file number 21 is deleted

| DIRECTORY (M-CARD) | | | O0034 N00045 |
|--------------------|-----------|--|----------------|
| No. | FILE NAME | | COMMENT |
| 0019 | O1000 | | (MAIN PROGRAM) |
| 0020 | O1010 | | (SUBPROGRAM-1) |
| 0021 | O1020 | | (COMMENT) |
| 0022 | O1030 | | (COMMENT) |

~

File name O1020 is deleted.

| DIRECTORY (M-CARD) | | | O0034 N00045 |
|--------------------|-----------|--|----------------|
| No. | FILE NAME | | COMMENT |
| 0019 | O1000 | | (MAIN PROGRAM) |
| 0020 | O1010 | | (SUBPROGRAM-1) |
| 0021 | O1020 | | (COMMENT) |
| 0022 | O1030 | | (COMMENT) |

~



File number 21 is assigned to the next file name.

Batch input/output with a memory card

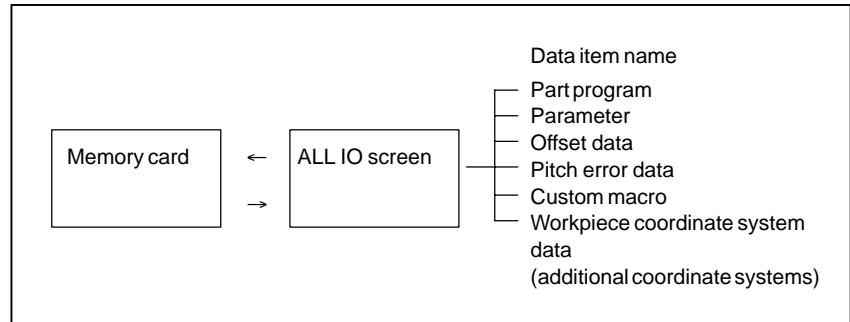
On the ALL IO screen, different types of data including part programs, parameters, offset data, pitch error data, custom macros, and workpiece coordinate system data can be input and output using a memory card; the screen for each type of data need not be displayed for input/output.



Procedure



- 1 Press the EDIT switch on the machine operator's panel.
- 2 Press function key .
- 3 Press the rightmost soft key  (continuous menu key) several times.
- 4 Press soft key **[ALL IO]**. The screen shown below is displayed.

```

READ/PUNCH (PROGRAM)
No.  FILE NAME      SIZE      O0001 N00001
      DATE
*0001 O0222          332010   01-04-06
0002  O1003          334450   01-05-04
0003  MACROVAR.DAT  653400   01-05-12
0004  O0002          341205   01-05-13
[PROGRAM]
O0001 O0002 O0003 O0005 O0100 O0020
O0006 O0004 O0110 O0200 O2200 O0441
O0330
>
EDIT *** ***** 10:07:37
{ PROG } { PARAM } { OFFSET } { (OPRT) }
  
```



Upper part : Directory of files on the memory card

Lower part : Directory of registered programs

- 5 With cursor keys  and , the user can choose between upper part scrolling and lower part scrolling. (An asterisk (*) displayed at the left edge indicates the part for which scrolling is possible.)

 : Used for memory card file directory scrolling.

 : Used for program directory scrolling.

- 6 With page keys  and , scroll through the file directory or program directory.
- 7 When this screen is displayed, the program data item is selected. The soft keys for other screens are displayed by pressing the rightmost soft key  (continuous menu key).

(PITCH) (WORK) () () ((OPRT))

When a data item other than program is selected, the screen displays only a file directory.

A data item is indicated, in parentheses, on the title line.

| READ/PUNCH (PARAMETER) | | O0001 | N00001 |
|------------------------|--------------|--------|----------|
| No. | FILE NAME | SIZE | DATE |
| 0001 | O0222 | 32010 | 96/04/06 |
| 0002 | O1003 | 4450 | 96/05/04 |
| 0003 | MACROVAR.DAT | 653400 | 96/05/12 |
| 0004 | O0003 | 4610 | 96/05/04 |
| 0005 | O0001 | 4254 | 96/06/04 |
| 0006 | O0002 | 750 | 96/06/04 |
| 0007 | CNCPARAM.DAT | 34453 | 96/06/04 |

- 8 Display the following soft keys with soft key **[(OPRT)]**.

(F SRH) (F READ) (N READ) (PUNCH) (DELETE)

The operation of each function is the same as on the directory (memory card) screen. Soft key **[O SET]**, used for program number setting, and the “PROGRAM NUMBER =” indication are not displayed for data items other than program.

- [F SRH]** : Finds a specified file number.
- [F READ]** : Reads a specified file number.
- [PUNCH]** : Writes a file.
- [N READ]** : Reads a file under a specified file name.
- [DELETE]** : Deletes a specified file number.

Error codes

Memory card error codes

| Code | Meaning |
|-------------|---|
| 007 | The memory card is protected. |
| 030 | The memory card is not inserted into its slot. |
| 032 | The memory card's battery is exhausted. |
| 102 | The memory card does not have sufficient free space. |
| 105 | No memory card is mounted. |
| 106 | A memory card is already mounted. |
| 110 | The specified directory cannot be found. |
| 111 | There are too many files under the root directory to allow a directory to be added. |
| 114 | The specified file cannot be found. |
| 115 | The specified file is protected. |
| 117 | The file has not yet been opened. |
| 118 | The file is already open. |
| 119 | The file is locked. |
| 121 | A file end was detected. |
| 122 | The specified file name is invalid. |
| 124 | The extension of the specified file is invalid. |
| 129 | A non-corresponding function was specified. |
| 130 | The specification of a device is invalid. |
| 131 | The specification of a pathname is invalid. |
| 133 | Multiple files are open at the same time. |
| 135 | The device is not formatted. |
| 140 | The file has the read/write disabled attribute. |

4

INTERFACE BETWEEN CNC AND PMC

This chapter describes the signals between the machine operator's panel, magnetics cabinet and the PMC, connection of the signals between PMC and CNC, and confirmation method of on/off state of these signals. It also describes system configuration of PMC, parameters of PMC, ladder and how to display time chart of the signals on the screen. It also describes a method of inputting/outputting PMC parameters to an external device.

| | | |
|-----|------------------------------------|-----|
| 4.1 | GENERAL OF INTERFACE | 287 |
| 4.2 | SPECIFICATION OF PMC | 288 |
| 4.3 | PMC SCREEN (PMC-SA1) | 298 |
| 4.4 | PMC SCREEN (PMC-SB7) | 321 |
| 4.5 | LIST OF SIGNALS BY EACH MODE | 354 |
| 4.6 | LIST OF INPUT/OUTPUT SIGNALS | 356 |
| 4.7 | LIST OF ADDRESSES | 371 |

4.1 GENERAL OF INTERFACE

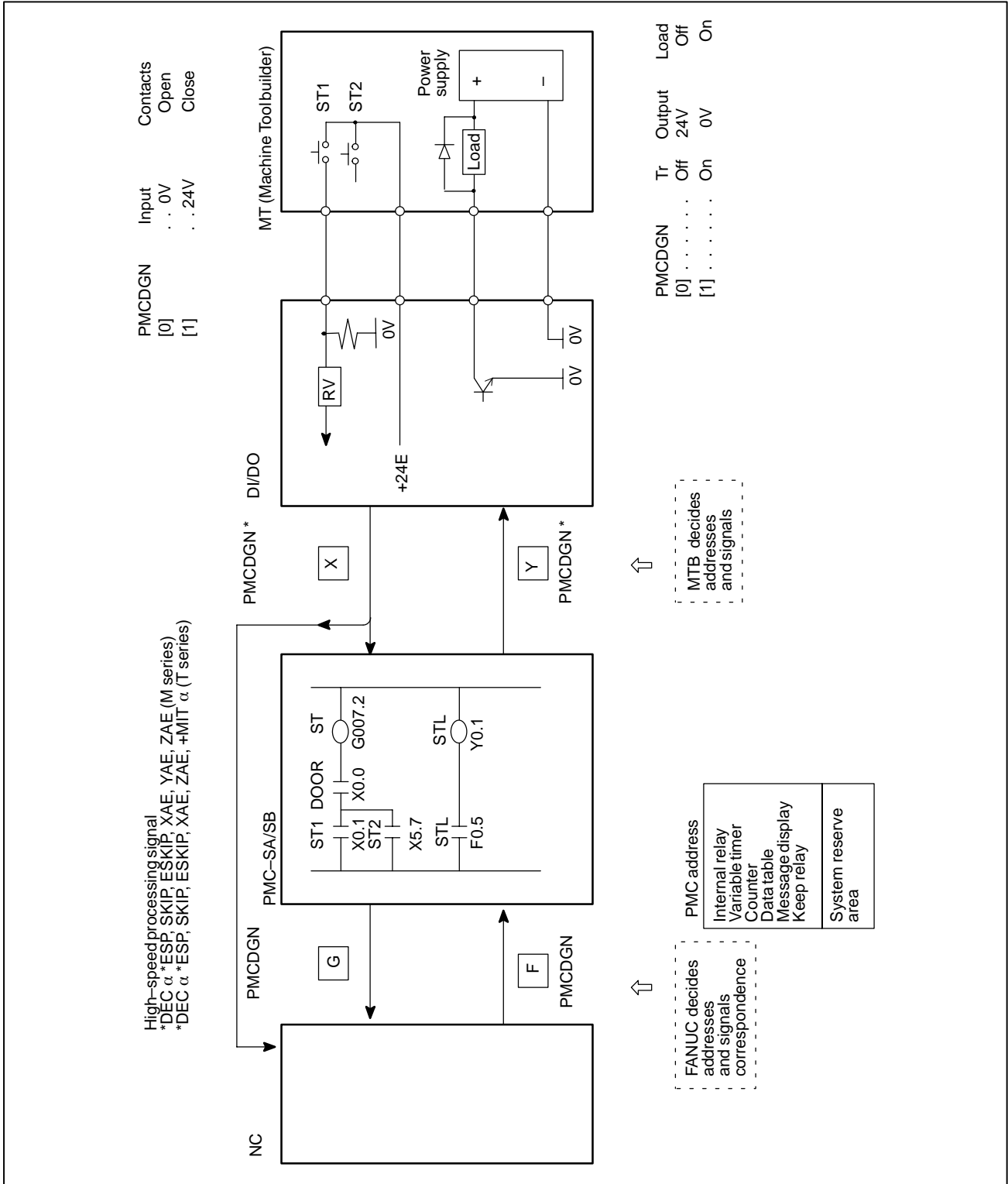

4.2 SPECIFICATION OF PMC

4.2.1 Specification

| Function | Series 0i-C/0i Mate-C | Series 0i-C |
|--|---|--|
| | PMC-SA1 | PMC-SB7 |
| Programming method | Ladder | Ladder |
| Number of ladder levels | 2 | 3 |
| 1st level execution period | 8ms | 8ms |
| Basic instruction execution time | 5.0 μ sec/step | 0.033 μ sec/step |
| Program size <ul style="list-style-type: none"> • Ladder • Symbol/comment • Message | 5,000 steps max. 1 to 128 KB 0.1 to 64 KB | Approx. 24,000 steps max. (NOTE 1, 2) 1 KB and up (NOTE 2) 8 KB and up (NOTE 2) |
| Instruction (basic) (functional) | 12 48 | 14 69 |
| Internal relay (R) | 1,100 bytes | 8,500 bytes |
| Extended relay (E) | – | 8,000 bytes |
| Message request (A) | 200 requests (25 bytes) | 2,000 requests (500 bytes, 2 bits/request) |
| Nonvolatile memory and so on <ul style="list-style-type: none"> • Data table (D) • Variable timer (T) Fixed timer • Counter (C) Fixed counter (C) • Keep relay (K) | 1,860 bytes 40 units (80 bytes) 100 units 20 units (80 bytes) – 20 bytes | 10,000 bytes 250 units (1,000 bytes, 4 bytes/unit) 500 units (timer number specification) 100 units (400 bytes, 4 bytes/unit) 100 units (200 bytes, 2 bytes/unit) 120 bytes |
| Subprogram (P) | – | 2,000 programs |
| Label (L) | – | 9,999 units |
| Input/output (I/O Link) <ul style="list-style-type: none"> • Input • Output | 240 points max. 160 points max. | 1,024 points max. 1,024 points max. |
| Sequence program storage memory | Flash ROM 128KB | Flash ROM 128 KB 256 KB |

NOTE

- 1 The maximum number of steps assumes programming using basic instructions. The maximum number of steps varies according to the status of functional instruction use.
- 2 The total sequence program size (including all of the ladders, symbols/comments, and messages) must not exceed the capacity of the sequence program storage memory. If the size of any of the ladders, symbols/comments, or messages is greater, the maximum allowable size of the others may be limited.

4.2.2 Address

| Char-acter | Signal type | Model | |
|------------|---|------------------------------|--|
| | | Series 0i-C/0i Mate-C | |
| | | PMC-SA1 | PMC-SB7 |
| X | Input signal from the machine to the PMC (MT to PMC) | X0 to X127 | X0 to X127 X200 to X327(NOTE 1) X1000 to X1127(NOTE 1) |
| Y | Output signal from the PMC to the machine (PMC to MT) | Y0 to Y127 | Y0 to Y127 Y200 to Y327(NOTE 1) Y1000 to Y1127 (NOTE 1) |
| F | Input signal from the NC to the PMC (NC to PMC) | F0 to F255 | F0 to F767(NOTE 2) F1000 to F1767(NOTE 3) F2000 to F2767(NOTE 3) F3000 to F3767(NOTE 3) |
| G | Output signal from the PMC to the NC (PMC to NC) | G0 to G255 | G0 to G767(NOTE 2) G1000 to G1767(NOTE 3) G2000 to G2767(NOTE 3) G3000 to G3767(NOTE 3) |
| R | Internal relay | R0 to R999 R9000 to R9099 | R0 to R7999 R9000 to R9499(NOTE 4) |
| E | Extended relay | – | E0 to E7999(NOTE 5) |
| A | Message display request signal | A0 to A24 | A0 to A249 |
| | Message display state signal | – | A9000 to A9249(NOTE 6) |
| C | Counter | C0 to C79 | C0 to C399 C5000 to C5199(NOTE 7) |
| K | Keep relay | K0 to K19 | K0 to K99 K900 to K919(NOTE 8) |
| T | Variable timer | T0 to T79 | T0 to T499 T9000 to T9499(NOTE 9) |
| D | Data table | D0 to D1859 | D0 to D9999 |
| L | Label number | – | L1 to L9999 |
| P | Subprogram number | – | P1 to P2000 |

NOTE

- 1 This area is reserved for the PMC. I/O cannot be assigned to this area. Do not use this area for sequence programs.
- 2 This area includes an area reserved for the PMC. The actually usable address range depends on the CNC system configuration.
- 3 This area is reserved for the PMC. Do not use this area for sequence programs.
- 4 This area is a special relay area managed by the PMC system program. When using this area, follow the description of each signal.
- 5 In an ordinary system, this area can be used as with the internal relay (R) area. The extended relay (E) area is volatile, but a signal is input to or output from a memory card as a PMC parameter. When a PMC parameter is read, the E area is initialized to the state present at the time of PMC parameter output.
- 6 Message display state signals corresponding to message display request signals on a one-to-one basis. This area cannot be written to.
- 7 This area is used for the fixed counter instruction (CTRB instruction), which specifies a preset value as a constant.
- 8 This area is a special relay area for PMC management software. When using this area, follow the description of each address.
- 9 This area is reserved for the PMC. Do not use this area for sequence programs.

**4.2.3
System Reserve Area
of Internal Relay**

(1) R9000 (Operation output register for the ADD, SUB, MULB, DIVB, and COMPB functional instructions)

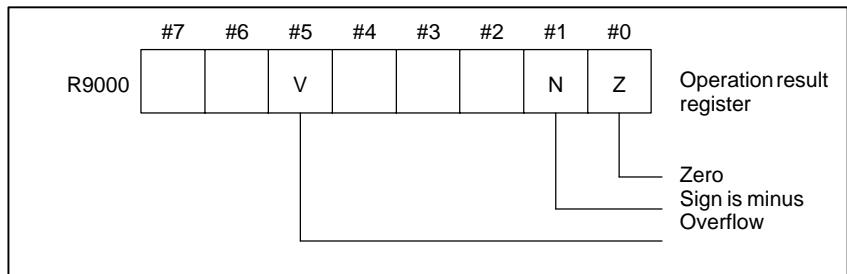

(2) R9000 (Error output for the EXIN, WINDR, WINDW, MMCWR, and MMCWW functional instructions)

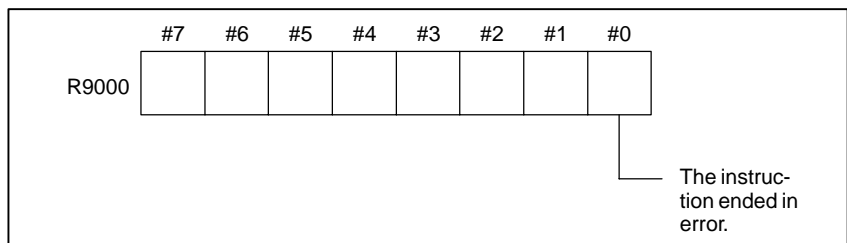

(3) R9002 to R9005 (Operation output registers for the DIVB functional instruction)

The data remaining after the DIVB functional instruction is executed in output.

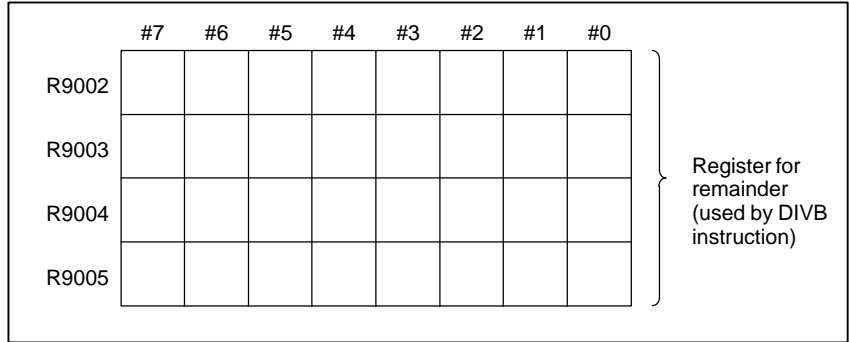

(4) R9091 (System timer)

4 signals can be used as system timer.

The specifications of every signal are as following.

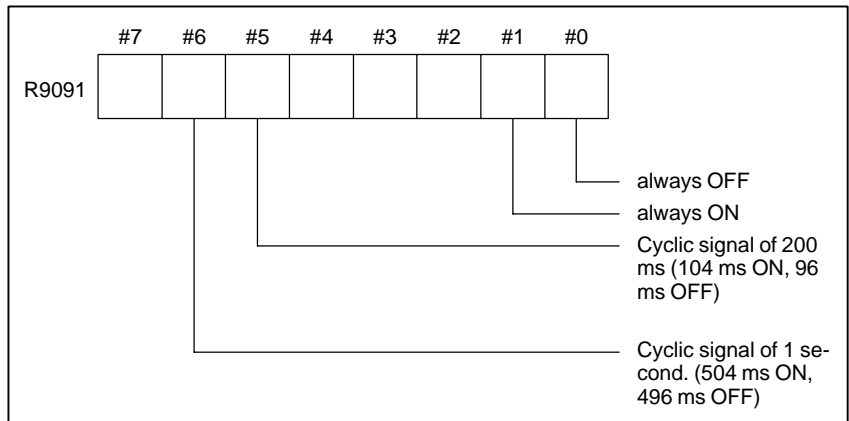

CAUTION

Each signal is initially off. R9091.0 and R9091.1 are set cyclically at the beginning of the first ladder level. Each signal (ON-OFF signal) has an accuracy of ± 8 ms.

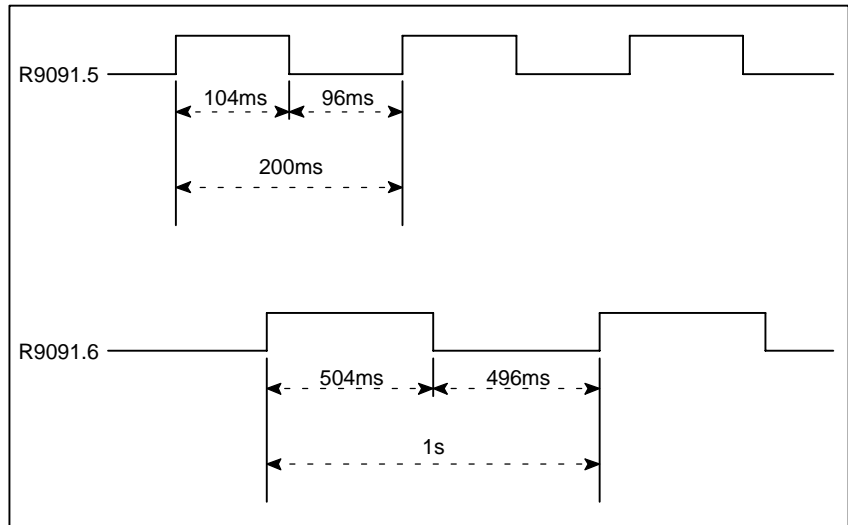

(5) Ladder execution start signal, ladder stop signal, ladder execution state signal (PMC-SB7)

1 Ladder execution start signal and latter stop signal

With the ladder execution start signal or the ladder stop signal, the start or stop of a ladder program can be known in the ladder program.

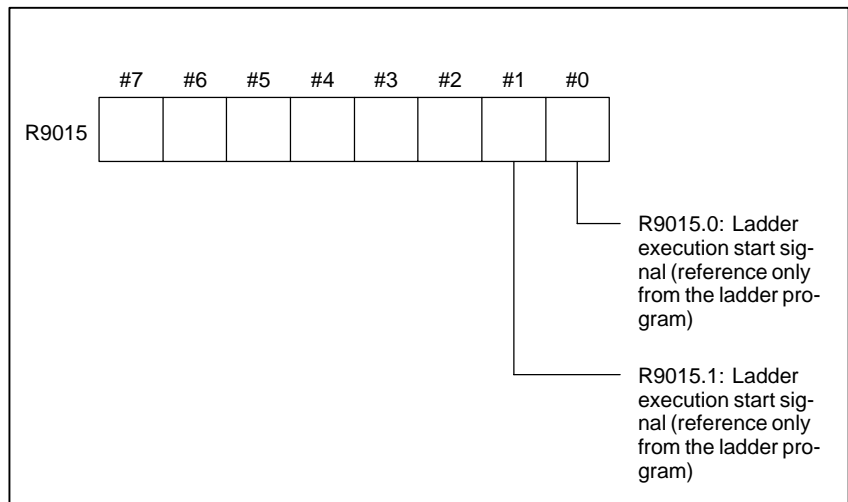

2 Ladder execution state signal

The state of ladder program execution or PMCC language program execution can be known by referencing the ladder execution state signal from an external system or program such as the network board, C executor program, FOCAS1 Ethernet, and HSSB library.

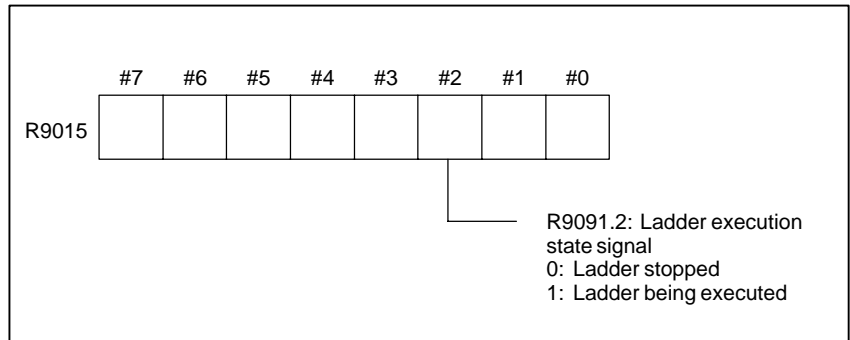

4.2.4 Execution Period of PMC

For PMC-SA1

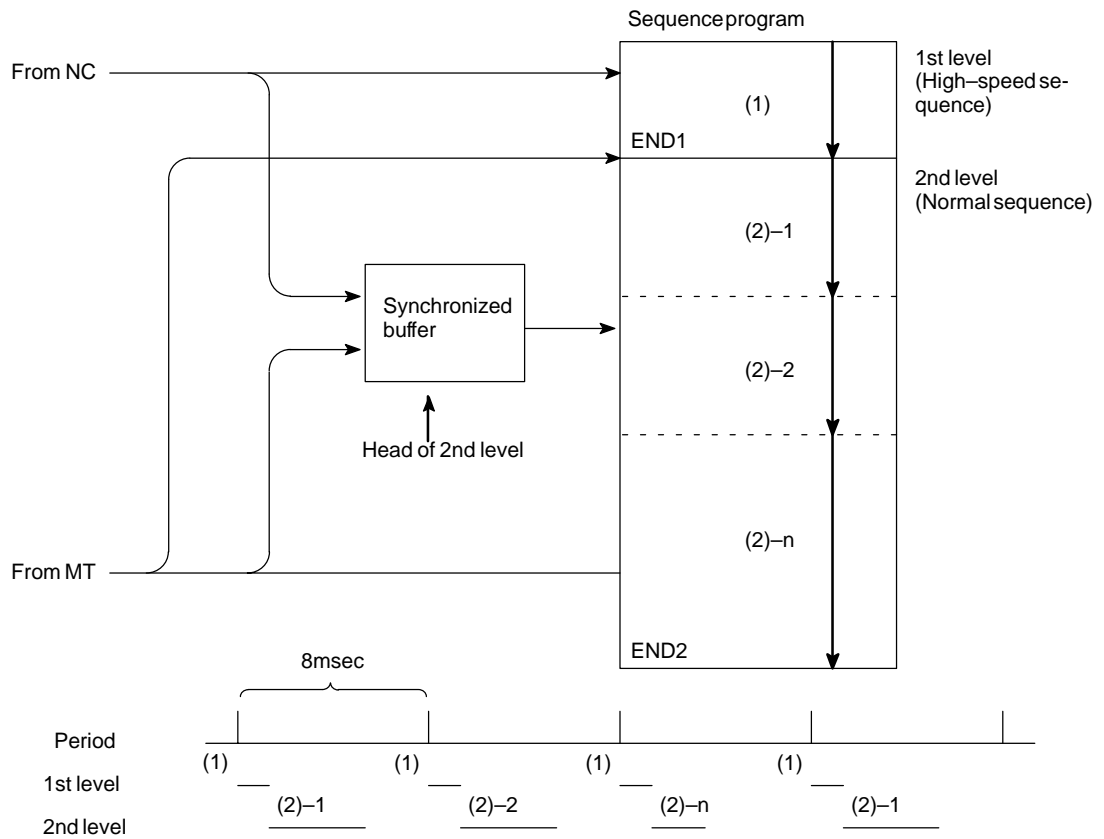

For PMC-SB7

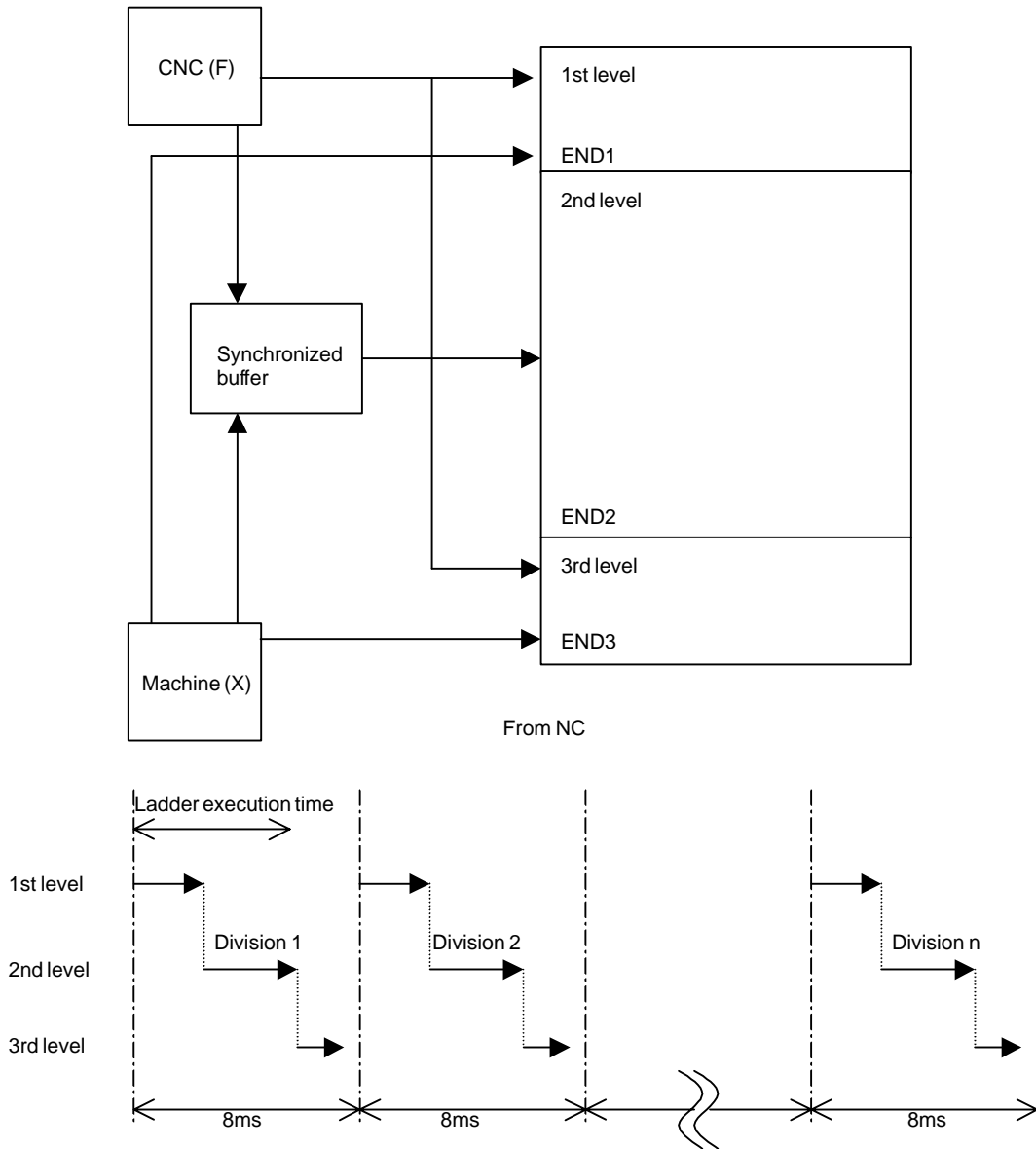

The ratio of the 1st level execution time to the 2nd level execution time is set in a system parameter for ladder execution time.

- For a ladder that uses the 1st level and the 2nd level only, set the upper limit (150).

- For a ladder that uses the 3rd level, the setting of the upper limit (150) may not ensure full 3rd level operation. In such a case, set this parameter so that the processing times of the 1st level and 2nd level are reduced.

The 1st ladder level or the 2nd ladder level processing time is determined by the following expression:

$$\text{The 1st ladder level or 2nd ladder level processing time} = 5\text{msec} \times \frac{\text{Ladder execution time}}{100}$$

The 3rd ladder level processing time is determined by the following expression:

$$\text{The 3rd ladder level processing time} = 7.5 \text{ msec} - (\text{1st ladder level and 2nd ladder level processing times})$$

4.2.5 I/O Module Assignment Name List

(a) Input modules

| Input format | Module name (Actual module name) |
|---------------------------------|-------------------------------------|
| Non-insulation type DC input | ID32A (AID32A) |
| | ID32B (AID32B) |
| Non-insulation type DC input | ID16C (AID16C) |
| | ID16D (AID16D) |
| | ID32E (AID32E) |
| | ID32F (AID32F) |
| Non-insulation type DC input | IA16G (AIA16G) |

(b) Output modules

| Input format | Module name (Actual module name) |
|-----------------------------|-------------------------------------|
| Insulation type DC input | OD08C (AOD08C) |
| | OD08D (AOD08D) |
| | OD16C (AOD16C) |
| | OD16D (AOD16D) |
| | OD32C (AOD32C) |
| | OD32D (AOD32D) |

| Input format | Module name (Actual module name) |
|--------------|-------------------------------------|
| AC output | OA05E (AOA05E) |
| | OA08E (AOA08E) |
| | OA12E (AOA12E) |
| Relay output | OA08G (AOA08G) |
| | OA16G (AOA16G) |

(c) Other modules

| Name | Module name | Occupied address |
|--|-------------------|---------------------------------|
| FANUC CNC SYSTEM FANUC Power Mate | FS04A | Input 4 bytes Output 4 bytes |
| | FS08A | Input 8 bytes Output 8 bytes |
| | OC02I | Input 16 bytes |
| | OC02O | Output 16 bytes |
| | OC03I | Input 32 bytes |
| | OC03O | Output 32 bytes |
| Analog input module | AD04A (AAD04A) | Input 8 bytes |
| Analog output module | DA02A (ADA02A) | Output 4 bytes |
| Connection unit (1 unit) | CN01I | Input 12 bytes |
| Connection unit (1 unit) | CN01O | Output 8 bytes |
| Connection unit (2 units) | CN02I | Input 24 bytes |
| Connection unit (2 units) | CN02O | Output 16 bytes |
| Operator's panel connection unit I/O card E | OC01I | Input 12 bytes |
| | OC01O | Output 8 bytes |
| Operator's panel connection unit I/O card D | /8 | Input 8 bytes |
| | /4 | Output 4 bytes |
| Machine operator's panel interface unit | OC02I | Input 16 bytes |
| | OC02O | Output 16 bytes |
| | OC03I | Input 32 bytes |
| | OC03O | Output 32 bytes |
| I/O Link connection unit | /□ | Input □ bytes Output □ bytes |
| | OC02I | Input 16 bytes |
| | OC02O | Output 16 bytes |
| | OC03I | Input 32 bytes |
| | OC03O | Output 32 bytes |
| For I/O Unit MODEL B | #□ | Input □ bytes Output □ bytes |
| | ## | Input 4 bytes |

| Name | Module name | Occupied address |
|---|--------------|---------------------------------|
| Special module | /□ | input □ bytes output □ bytes |
| | OC02I | Input 16 bytes |
| | OC02O | Output 16 bytes |
| | OC03I | Input 32 bytes |
| | OC03O | Output 32 bytes |
| Module for distributed I/O and distribution panel I/O | CM03I(/3) | Input 3 bytes |
| | CM06I(/6) | Input 6 bytes |
| | CM09I | Input 9 bytes |
| | CM12I(OC01I) | Input 12 bytes |
| | CM13I | Input 13 bytes |
| | CM14I | Input 14 bytes |
| | CM15I | Input 15 bytes |
| | CM16I(OC02I) | Input 16 bytes |
| | CM02O(/2) | Output 2 bytes |
| | CM04O(/4) | Output 4 bytes |
| | CM06O(/6) | Output 6 bytes |
| | CM08O(/8) | Output 8 bytes |
| Module for distributed I/O and distribution panel I/O | CM06I(/6) | Input 6 bytes |
| | CM13I | Input 13 bytes |
| | CM14I | Input 14 bytes |
| | CM15I | Input 15 bytes |
| | CM16I(OC02I) | Input 16 bytes |
| | CM04O(/4) | Output 4 bytes |
| External I/O card A,D for Power Mate | /6 | Input 6 bytes |
| | /4 | Output 4 bytes |
| External I/O card B,E for Power Mate | OC01I | Input 12 bytes |
| | OC01O | Output 8 bytes |
| Built-in I/O Card for Series 0i-B | CM16I(OC02I) | Input 16 bytes |
| | CM08O(/8) | Output 8 bytes |

4.3 PMC SCREEN (PMC-SA1)

4.3.1 PMC Menu Selection Procedure Using Soft Keys

PMC-SA1 screen menu selection procedure

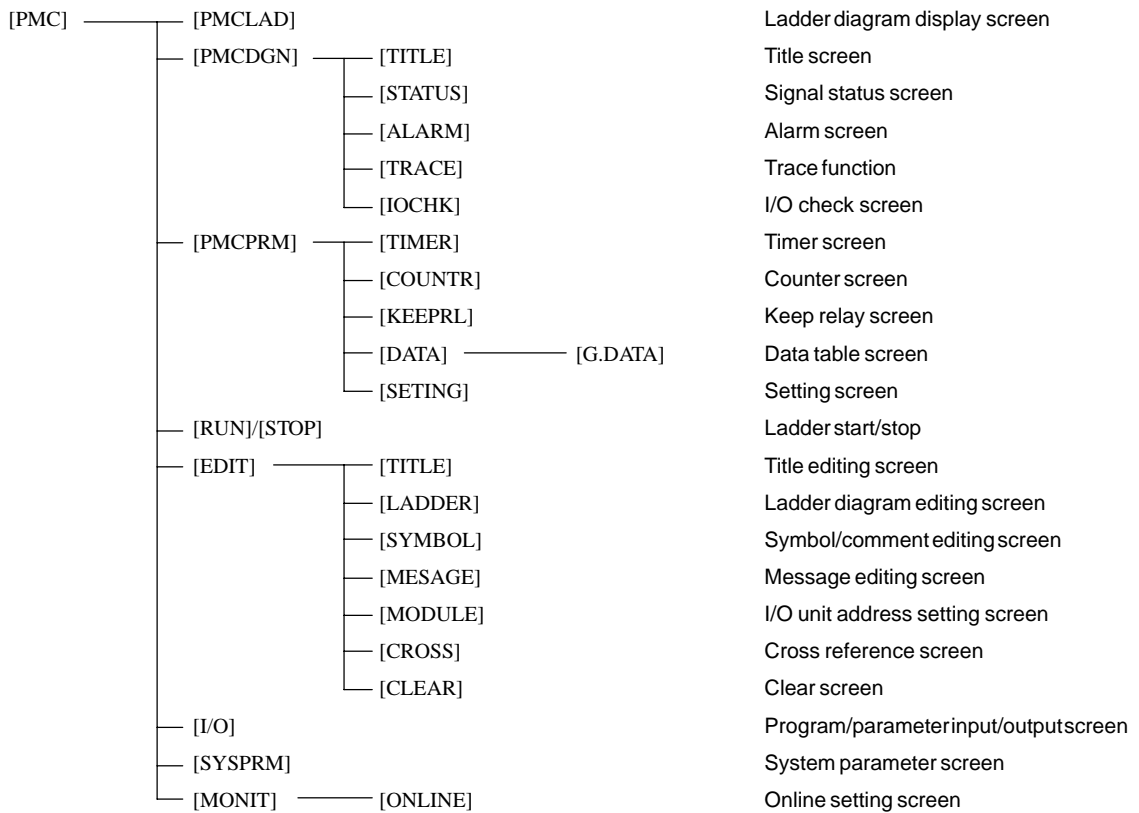

4.3.2 Dynamic Display of Sequence Program

(1) Display method

- 1 Press the  key, then press the soft key [PMC].
- 2 Dynamic display of sequence program by pressing [PMCLAD] soft key.



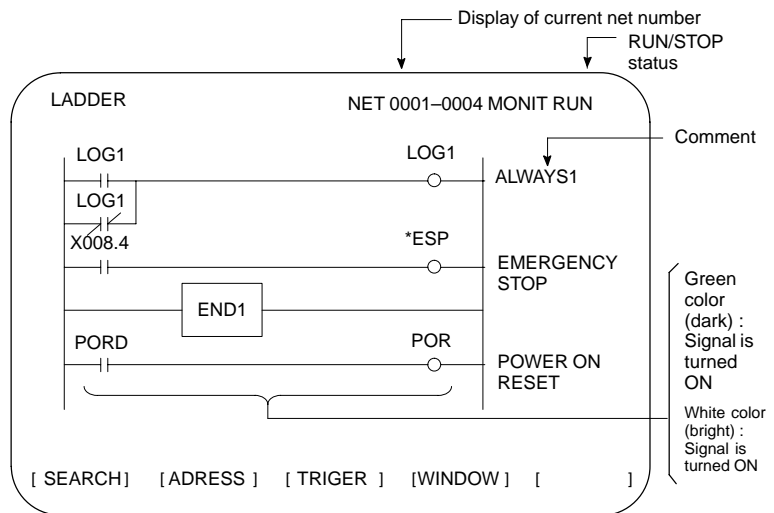



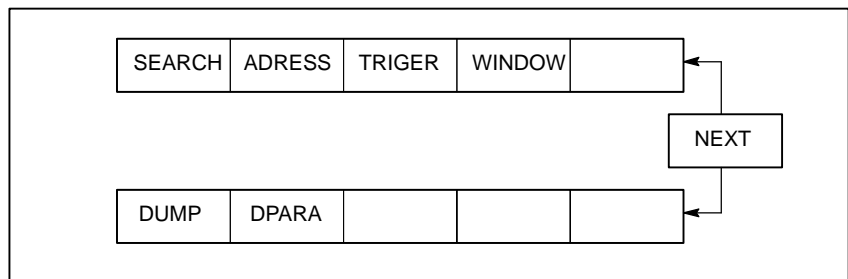

(2) Display information



● Soft key

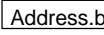

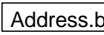
(3) Searching for the signal (SEARCH)

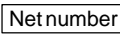
- 1 Press the [SEARCH] soft key.
- 2 Using the following keys as described below, search for desired signal.
 - The signals being displayed can be changed by using the , , , and  keys.
 - [TOP]: Locates the top of the ladder program.
 - [BOTTOM] : Locates the end of the ladder program.
 -  [SRCH] or  [SRCH] : Search a specified address unconditionally.
 -  [W-SRCH] or  or [W-SRCH] : Searches for a specified address, for the write coils.
 -  [N-SRCH]: Displays the ladder program from the specified net address.

- [F-SRCH] or [F-SRCH]: Searches for the specified function instruction.
- [ADDRESS]: Displays the address and bit number of the specified signal.
- [SYMBOL]: Displays the symbol of the specified signal. (The address of the specified signal is displayed if a symbol was not specified when the program was created.)

(4) Turning off the monitor display when the trigger signal changes (TRIGGER)

When the preset trigger signal changes, the system turns off the monitor display. By using this function, the states of all signals can be accurately read when the trigger signal changes.

- 1 Press the [TRIGGER] soft key.

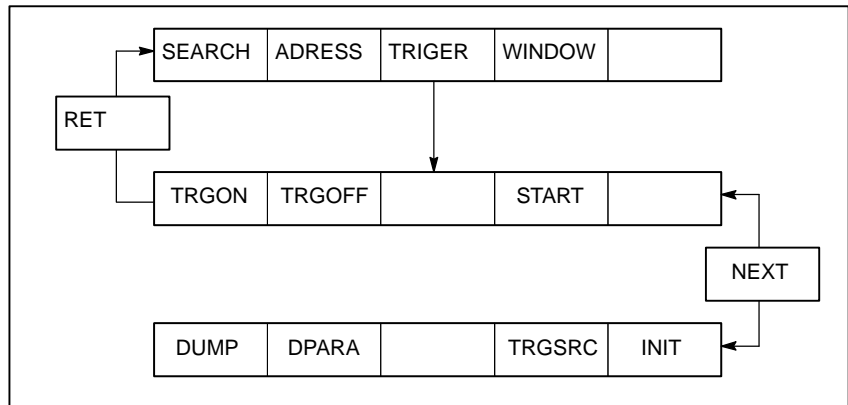

- 2 Press the [INIT] soft key to initialize the trigger parameters.
- 3 Specify the trigger conditions.
 - To turn off the monitor display at the signal's rising edge (as the signal changes from 0 to 1), enter the desired data and press the required keys in the order shown below.

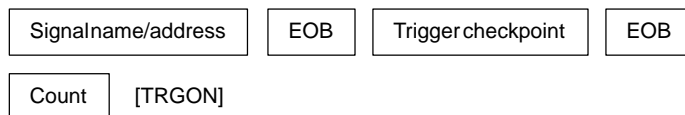

* Trigger checkpoint:

- 0: Before the first level of the ladder program is executed
- 1: After the first level of the ladder program is executed
- 2: After the second level of the ladder program is executed
- 3: After the third level of the ladder program is executed

Example) To set the system so that it turns off the monitor display when the external reset signal (ERS) is input three times, enter the required data and press the required keys in the order shown below:

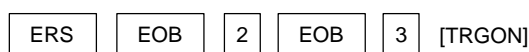

The specified trigger conditions are displayed at the top of the screen.

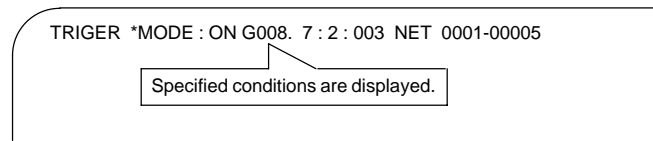

To turn off the monitor display at the signal's falling edge (as the signal changes from 1 to 0), enter the desired data and press the required keys in the order shown below.

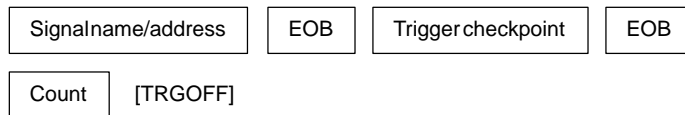

- 4 Press the [START] soft key to activate the trigger function.
 - While the trigger function is operating, **TRG** is displayed at the lower right corner of the screen. When the trigger conditions are satisfied, **TRG** disappears and the monitor screen is locked.
- 5 To interrupt the trigger function, press the [STOP] soft key while the function is effective.
 - In this case, the specified trigger conditions remain effective. Pressing the [START] soft key reinstates the trigger function.
- 6 To search for the instruction where the program was stopped by the trigger function and blink that instruction, press the [TRGSRC] soft key.

NOTE

- 1 Because parameters are stored in the nonvolatile memory, they are not lost even if the power is turned off.
- 2 When bit 2 of keep relay K18 is set to 1 after parameters for sampling are specified, the trigger function automatically starts when the power is turned on.

(5) Displaying a divided ladder program (WINDOW)

A ladder program can be divided into up to six sections, and the individual sections displayed on the screen simultaneously.

- 1 Press the [WINDOW] soft key.

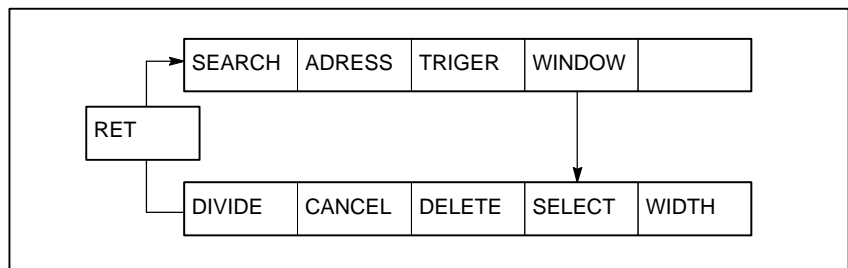

- 2 Press the [DIVIDE] soft key to divide the dynamic display screen into the desired number of sections.
 - * Each time the key is pressed, the screen is divided.

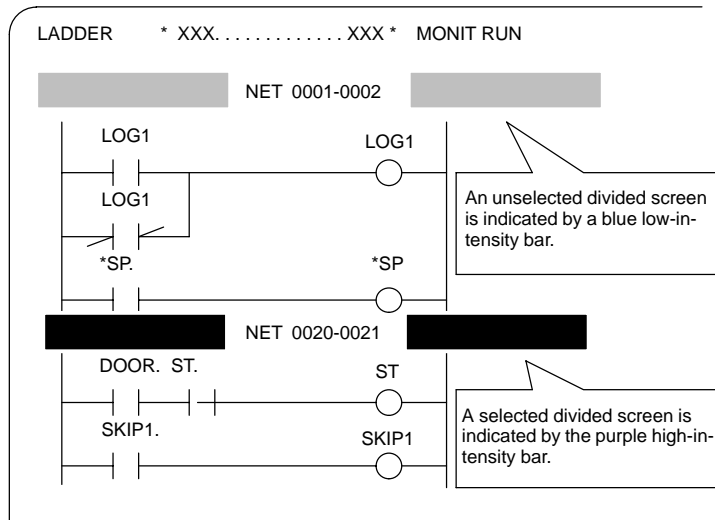

- 3 To select the desired divided screen, press the [SELECT] soft key as many times as necessary to move the purple bar to the desired screen.
 - * The normal search function can be used within each divided screen.
- 4 To change the width of a selected divided screen, press the [WIDTH] soft key.
 - Pressing the [EXPAND] soft key increases the number of lines displayed on a divided screen.
 - Pressing the [SHRINK] soft key decreases the number of lines displayed on a divided screen.
- 5 To terminate the display of a selected divided screen, press the [DELETE] soft key.
 - * To terminate screen division, press the [CANCEL] soft key.

(6) Dumping (DUMP)

The states of the signals corresponding to a ladder program can be displayed in hexadecimal, together with the ladder program itself.

- 1 Press the [DUMP] soft key.

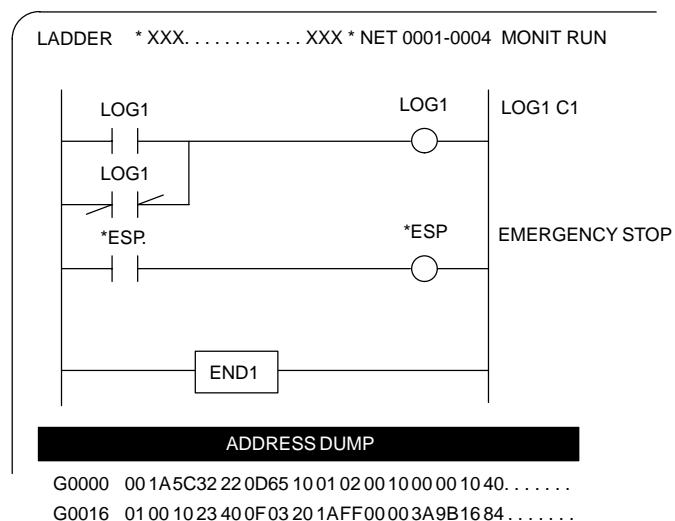

- * When the screen is divided, the states of the signals are displayed in the lower divided screen.

- To change the data notation

[BYTE] : Data is displayed in units of bytes.

Example) G0000 00 16 84 00 ...

[WORD] : Data is displayed in units of two bytes.

Example) G0000 1600 0084 ...

[D.WORD] : Data is displayed in units of two words, or four bytes.

Example) G0000 00841600 ...

✳ When WORD or D.WORD is specified, data is displayed with the high-order byte placed first.

- To search for an address

Use the , , and [SRCH] keys, as in the normal search function.

(7) Displaying the function-instruction parameters (DPARA/NDPARA)

The states of the control parameters used in function instructions are displayed together with the ladder program.

- 1 Press the [DPARA] soft key.

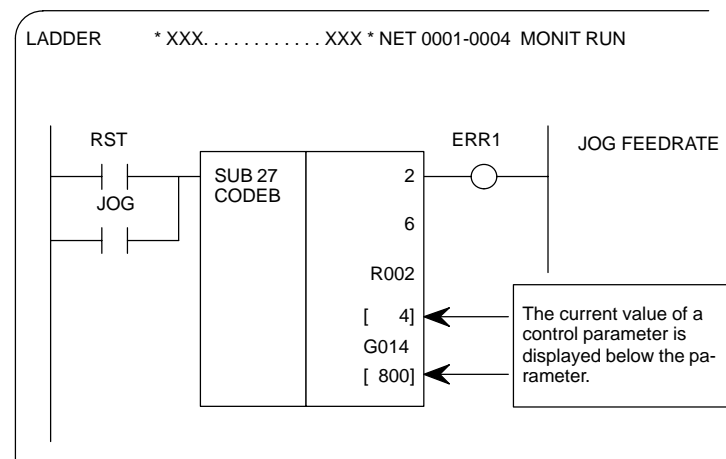

✳ The data notation (binary or BCD) varies with the function instructions.

- 2 To terminate the display of parameters, press the [NDPARA] soft key.

(8) Editing the program being executed (ONLEDT: on-line editing)

A sequence program can be edited while a program is being executed, without stopping its execution.

✳ This function is available only while the edit function is enabled.

- 1 Press the [ONLEDT] soft key to start the on-line editing function. The cursor appears on the screen.
- 2 Modify the program, following the usual editing procedure. The following changes can be made by means of on-line editing.
 - Changing the type of contacts (\neg | \neg | \neg)
 - Changing the addresses of contacts and coils
 - Changing the addresses of control parameters used in function instructions

✧ The operations that can be performed in on-line editing are restricted to those that do not change the memory size of the program. To perform other operations, such as addition, insertion, and deletion, use the ordinary editing function.

3 To terminate on-line editing, press the  key.

✧ Changes made in on-line editing are temporary. To save a changed program, set K18.3 to 1 or transfer the program to the DRAM by using the COPY function from the I/O screen. To enable the use of the program when the system is next turned on, write it to the FROM from the I/O screen.

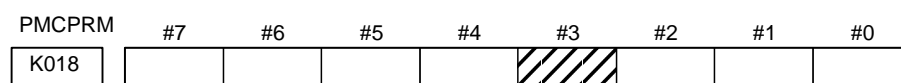

#3 0: The ladder program is not transferred to the RAM after on-line editing.

→ To transfer the program, press the following keys in the order shown, using the COPY function from the I/O screen:
[COPY], [EXELAD], [EXEC]

1: A ladder program is automatically transferred to the RAM after on-line editing.

4.3.3

Display of PMC Diagnosis Screen

(1) Display method

- 1 Press the  key.
- 2 Press the [PMC] soft key.
- 3 Display of PMC diagnosis screen by pressing [PMC/DGN] soft key.

4.3.3.1

Title screen (TITLE)

Display of the title data which is wrote at the ladder programming time.

| | |
|---|-----------|
| PMC TITLE DATA #1 | MONIT RUN |
| PMC PROGRAM NO. : EDITION NO. : PMC CONTROL PROGRAM SERIES : 408B EDITION : 01 (SERIES : EDITION :) PMC TYPE CONTROL : RB5 PROGRAM : RB5 MEMORY USED : KB LADDER : KB SYMBOL : KB MESSAGE : KB SCAN TIME : MS SCAN MAX : MS MIN: MS | |
| [TITLE] [STATUS] [ANALYS] [TRACE] [] | |

1) 1st page

PMC PROGRAM NO. : ██████
 EDITION NO. : ██████

} Set at LADDER programming time.

PMC CONTROL PROGRAM
 SERIES : ██████ EDITION : █
 (SERIES: ██████ EDITION : █)
 PMC TYPE CONTROL : ██████ PROGRAM : ██████
 MEMORY USED : ██████ KB
 LADDER : ██████ KB
 SYMBOL : ██████ KB
 MESSAGE : ██████ KB
 SCAN TIME : ██████ MS
 SCAN MAX : ██████ MS MIN : ██████ MS

} Display of a serial number and version number of PMC control software, used memory area and scan time.

2) 2nd page

MACHINE TOOL BUILDER NAME :
 MACHINE TOOL NAME :
 CNC & PMC TYPE NAME :
 PROGRAM DRAWING NO. :

} Set at LADDER diagram programming time.

3) 3rd page

DATE OF PRGRAMMING :
 PROGRAM DESIGNED BY :
 ROM WRITTEN BY :
 REMARKS :

4.3.3.2 Status screen (STATUS)

Display of ON/OFF condition for I/O signals, internal relays, etc.

| PMC SIGNAL STATUS | | | | MONIT RUN | | | | |
|-------------------|------|------|------|-----------|------|------|-----|-----|
| ADDRESS | 7 | 6 | 5 | 4 | 3 | 2 | 1 | 0 |
| G0000 | ED7 | ED6 | ED5 | ED4 | ED3 | ED2 | ED1 | ED0 |
| | 0 | 0 | 0 | 0 | 1 | 0 | 1 | 0 |
| G0001 | ED15 | ED14 | ED13 | ED12 | ED11 | ED10 | ED9 | ED8 |
| | 0 | 0 | 0 | 0 | 0 | 0 | 0 | 0 |
| G0002 | ESTB | EA6 | EA5 | EA4 | EA3 | EA2 | EA1 | EA0 |
| | 0 | 0 | 0 | 0 | 0 | 0 | 0 | 0 |
| G0003 | 0 | 0 | 0 | 0 | 0 | 0 | 0 | 0 |
| | | | | | FIN | | | |
| G0003 | 0 | 0 | 0 | 0 | 0 | 0 | 0 | 0 |

[SEARCH] [] [] [] [] []

Signal name
 Status of signal
 0 : OFF
 1 : ON

- 1 Search the diagnosis number by pressing keys.
- 2 Searching the specified address or signal name by pressing [SEARCH] soft key when inputted of Address and number or Single name

4.3.3.3

Display of an alarm when an alarm occurred in PMC program.

Alarm screen (ALARM)

| | |
|------------------------------------|------------|
| PMC ALARM MESSAGE ALARM NOTHING | MONIT RUN |
| [TITLE] | [STATUS] |
| [ALARM] | [TRACE] |
| [] | [] |

See Appendix A.2 for details of the alarms.

4.3.3.4

Record the signal status to the trace memory when the specified signal is changed.

Trace screen (TRACE)

(1) Trace parameter screen (TRCPRM)

| | |
|------------------------------|-----------|
| PMC SIGNAL TRACE | MONIT RUN |
| TRACE MODE : | |
| (0:1BYTE/1:2BYTE/2:WORD) | |
| 1ST TRACE ADDRESS CONDITION | |
| ADDRESS TYPE : (0:PMC/1:PHY) | |
| ADDRESS : | |
| MASK DATA : | |
| 2ND TRACE ADDRESS CONDITION | |
| ADDRESS TYPE : (0:PMC/1:PHY) | |
| ADDRESS : | |
| MASK DATA : | |
| [T.DISP] | [EXEC] |
| [] | [] |
| [] | [] |

(a) TRACE MODE: Select the trace mode.

0= 1 byte address signal trace

1= Independent 2 byte address signal trace

2= Continuous 2 byte address signal trace

(b) ADDRESS TYPE: 0= Set the trace address by PMC address

1= Set the trace address by physical address
(Using mainly by C language)

(c) ADDRESS : Set the trace address

(d) MASK DATA : Specify the trace bit by hexadecimal code.
For example, set the "E1" when trace the bit 7, 6, 5 and 0. Not execute the tracing when the bit 4, 3, 2 and 1 is changed, but, the signal status should recorded at tracing time.

(e.g) #7 #6 #5 #4 #3 #2 #1 #0

1 1 1 0 0 0 0 1:E1

« Correspond table between binary and hexadecimal code »

| | | | |
|-------------------------------------|-------------------------------------|-------------------------------------|-------------------------------------|
| 0000 ₂ : 0 ₁₆ | 0001 ₂ : 1 ₁₆ | 0010 ₂ : 2 ₁₆ | 0011 ₂ : 3 ₁₆ |
| 0100 ₂ : 4 ₁₆ | 0101 ₂ : 5 ₁₆ | 0110 ₂ : 6 ₁₆ | 0111 ₂ : 7 ₁₆ |
| 1000 ₂ : 8 ₁₆ | 1001 ₂ : 9 ₁₆ | 1010 ₂ : A ₁₆ | 1011 ₂ : B ₁₆ |
| 1100 ₂ : C ₁₆ | 1101 ₂ : D ₁₆ | 1110 ₂ : E ₁₆ | 1111 ₂ : F ₁₆ |

(e) [EXEC] soft key :

Start of tracing.

Clear the trace memory and trace memory contents are update when the specified signal are changed from previous ones.

The trace memory are always maintained up to the previous results for 256 bytes from the latest ones regardless of the time lapse.

(2 byte tracing = 128 times.)

(f) [T.DISP] soft key : Display of trace memory contents.

(2) Trace memory screen (T.DISP)

| PMC SIGNAL TRACE | | | | | | | | | | | MONIT RUN | | | | | | | | | | |
|----------------------|---|---|---|---|---|---|---|---|---|---|----------------------|---|---|---|---|---|--|--|--|--|--|
| 1ST ADDRESS=X008(E1) | | | | | | | | | | | 2ND ADDRESS=G000(FF) | | | | | | | | | | |
| NO. | 7 | 6 | 5 | 4 | 3 | 2 | 1 | 0 | 7 | 6 | 5 | 4 | 3 | 2 | 1 | 0 | | | | | |
| 0000 | . | . | . | . | . | . | . | . | . | . | . | . | . | . | . | . | | | | | |
| 0001 | 1 | 0 | 0 | 0 | 0 | 0 | 1 | 1 | 0 | 0 | 0 | 0 | 0 | 0 | 0 | 0 | | | | | |
| 0002 | 1 | 1 | 0 | 0 | 0 | 0 | 0 | 0 | 0 | 0 | 0 | 0 | 0 | 0 | 0 | 0 | | | | | |
| 0003 | 0 | 1 | 0 | 0 | 0 | 0 | 0 | 0 | 0 | 0 | 0 | 0 | 0 | 0 | 0 | 0 | | | | | |
| 0004 | . | . | . | . | . | . | . | . | . | . | . | . | . | . | . | . | | | | | |
| 0005 | . | . | . | . | . | . | . | . | . | . | . | . | . | . | . | . | | | | | |
| 0006 | . | . | . | . | . | . | . | . | . | . | . | . | . | . | . | . | | | | | |
| 0007 | . | . | . | . | . | . | . | . | . | . | . | . | . | . | . | . | | | | | |
| 0008 | . | . | . | . | . | . | . | . | . | . | . | . | . | . | . | . | | | | | |

← Trace address and mask data in ()

← Newest status
:(Period):off
1/:on

[TRCPRM] [STOP] [] [] []

[TRCPRM] soft key : Return to trace parameter setting screen

[STOP] soft key : Stop the trace operation.

[EXEC] soft key : Re-start of tracing (Clear the memory).

4.3.4 PMC Parameter

4.3.4.1 Input of PMC parameter from MDI

- 1 Select MDI mode or depress EMERGENCY STOP button.
- 2 [PWE] set to "1" on SETTING screen or PROGRAM PROTECT signal (KEY4) turn to "1".

| | PWE | KEY4 | |
|------------|-----|------|------------|
| Timer | ○ | | |
| Counter | ○ | ○ | either one |
| Keep relay | ○ | | |
| Data table | ○ | ○ | either one |

- 3 Select the display screen by soft key.
 [TIMER] : Timer screen
 [COUNTER] : Counter screen
 [KEEPRL] : Keep relay screen
 [DATA] : Data table screen
- 4 Move the cursor to desired number.
- 5 Input the and press key then the data inputted.
- 6 [PWE] on SETTING screen or [KEY4] return to "0" after data set.

4.3.4.2 Timer screen (TIMER)

This screen is used for setting timer time of the Timer instruction (SUB 3).

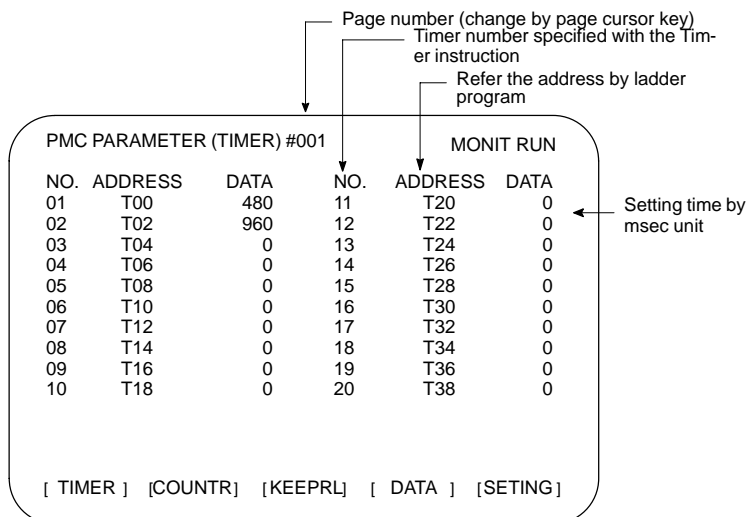

Setting time : Timer No. 1 – 8 =Max.=1572.8 sec, each 48msec.
 Up to 262.1 seconds in units of 8 ms for timer Nos. 9 to 40 subsequent timers

4.3.4.3 Counter screen (COUNTER)

Set and display the preset values and integrated values of the counter instruction (SUB 5).

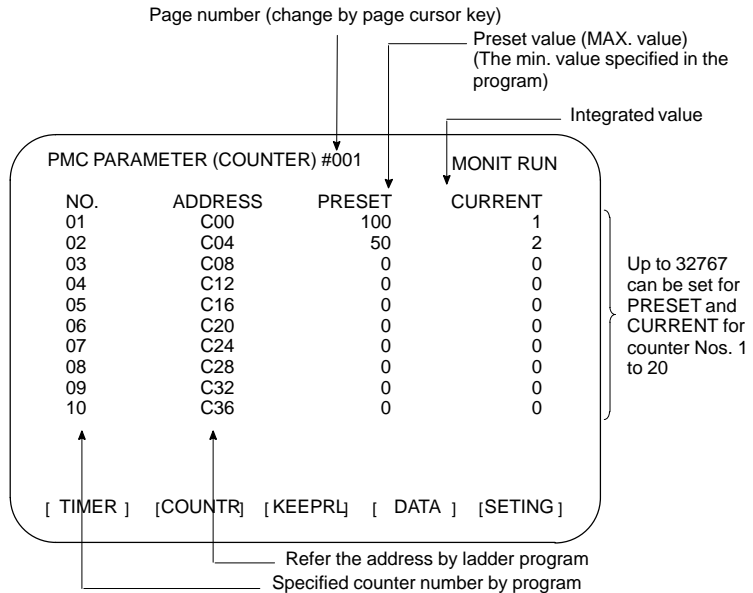

4.3.4.4 Keep relay screen (KEEPRL)

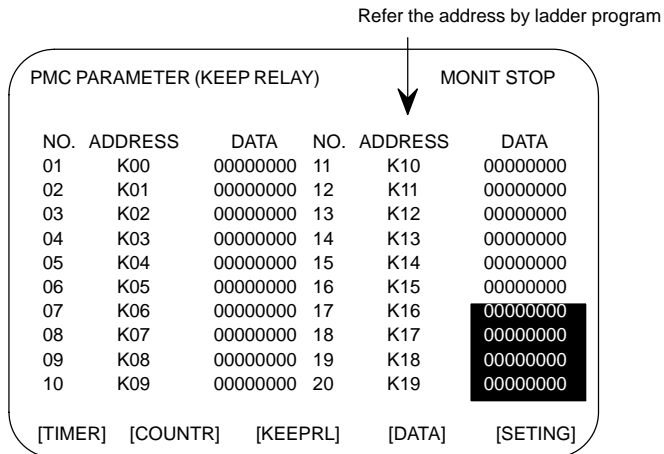

i) Control of battery-powered memory

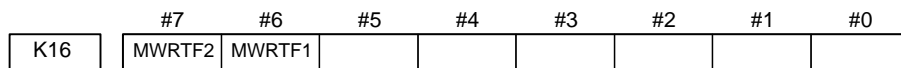

#7 MWRTF2: This operation is performed for checking the writing status of the nonvolatile memory.

#6 MWRTF1: Write status for battery-powered memory

ii) PMC system parameter

Since the system uses keep relays K17 to K19, they cannot be used by a sequence program.

| | #7 | #6 | #5 | #4 | #3 | #2 | #1 | #0 |
|-----|---------|---------|---------|--------|----|---------|--------|---------|
| K17 | DTBLDSP | ANASTAT | TRCSTAT | MEMINP | | AUTORUN | PRGRAM | LADMASK |

- #0 (LADMASK):** 0: The ladder programs are displayed dynamically (PCLAD).
1: The ladder programs are not displayed dynamically (PCLAD).
- #1 (PRGRAM):** 0: The built-in programmer function does not operate. (Also, the programmer menu is not displayed.)
1: The built-in programmer function operates. (The programmer menu is displayed.)
- #2 (AUTORUN):** 0: The sequence program automatically starts at power on.
1: Pressing the soft key to sequence program execution starts the sequence program.
- #4 (MEMINP):** 0: The forcing function is disabled.
1: The forcing function is enabled.
- #5 (TRCSTAT):** 0: Pressing the [EXEC] soft key starts tracing by the signal trace function.
1: The signal trace function automatically starts tracing at power on.
- #6 (ANASTAT):** 0: Pressing the soft key to execution starts sampling by the signal waveform display function.
1: The signal waveform display function automatically starts sampling at power on.
✳ This bit is only effective for those models for which the signal waveform display function is applicable.
- #7 (DTBLDSP):** 0: The PMC parameter data table control screen is displayed.
1: The PMC parameter data table control screen is not displayed.

| | #7 | #6 | #5 | #4 | #3 | #2 | #1 | #0 |
|------|---------|---------|---------|----------|---------|---------|---------|--------|
| K018 | IGNDINT | EDITLAD | CHKPRTY | CALCPRTY | TRNSRAM | TRGSTAT | DBGSTAT | IGNKEY |

- #0 (IGNKEY):** 0: Function keys are enabled for a user program on the user screen.
1: Function keys are disabled for a user program on the user screen.
✳ This flag is useful when a user program is used. When this bit is set to 1, the user screen cannot be switched to the NC screen by using the function keys. A program which invariably sets this bit to 0, or which switches the user screen to the NC screen, must be prepared.
- #1 (DBGSTAT):** 0: The C language debug function does not start automatic break processing at power on.
1: The C language debug function starts automatic break processing at power on.
✳ This flag is useful when a user program is used.
- #2 (TRGSTAT):** 0: The trigger stop function does not automatically start at power on.
1: The trigger stop function starts automatically at power on.

- #3 (TRNSRAM):** 0: After on-line editing, the ladder program is not automatically transferred to the backup RAM.
1: After on-line editing, the ladder program is automatically transferred to the backup RAM.
- #4 (CALCPRTY):** 0: The built-in programmer function calculates the RAM parity.
1: The built-in programmer function does not calculate the RAM parity.
- #5 (CHKPRTY):** 0: The system performs parity check for the system ROM, program ROM and program RAM.
1: The system does not perform parity check for the system ROM, program ROM, or program RAM.
- #6 (EDITLAD):** 0: The editing of a sequence program is disabled.
1: The editing of a sequence program is enabled.
- #7 (IGNDINT):** 0: The system initializes the LCD when the screen is switched to the PMCMDI screen.
1: The system does not initialize the LCD when the screen is switched to the PMCMDI screen.
* This flag is useful when a user program is used. When the screen is switched to the PMCMDI screen, PMC control software determines whether the system initialize the LCD, by checking this flag. When this flag is on, an application program must initialize the LCD.

| | | | | | | | | |
|------|---------|---------|----|----|----|--------|----------|----------|
| | #7 | #6 | #5 | #4 | #3 | #2 | #1 | #0 |
| K019 | PTCTPRM | HIDEPRM | | | | ALWSTP | C-REJECT | FROM-WRT |

- #0 (FROM_WRT):** 0: After editing a ladder or C program, does not automatically write it to F-ROM.
1: After editing a ladder or C program, automatically writes it to F-ROM.
- #1 (C-REJECT):** 0: The system activates a C program.
1: The system does not activate a C program.
- #2 (ALWSTP):** 0: The execution/stop operation of a sequence program is disabled.
1: The execution/stop operation of a sequence program is enabled.
- #6 (HIDEPRM):** 0: The display of PMC parameters and the output of PMC parameters to the outside are enabled.
1: The display of PMC parameters and the output of PMC parameters to the outside are disabled.
- #7 (PTCTPRM):** 0: The modification and reading of PMC parameters are enabled.
1: The modification and reading of PMC parameters are disabled.



CAUTION

Set all unused bits to 0.

4.3.4.5

Data table screen
(C. DATA)

1) DATA TABLE SETTING screen (C. DATA)

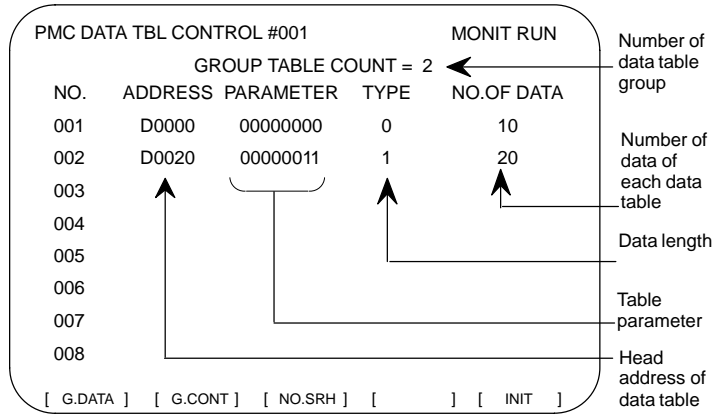

- (a) [G.DATA] soft key : Select the data display screen of data table.
- (b) [No. of group] [G.CONT] : Set the number of group for data table.
- (c) [No. of group] [NO.SRH] : Move the cursor to specified group.
- (d) [INIT] soft key : Initialize of data table setting.

No. of group is 1, ADDRESS is D0000, PARAMETER is 00000000, TYPE is 0, NO. OF DATA is 1860.

«Table parameter»

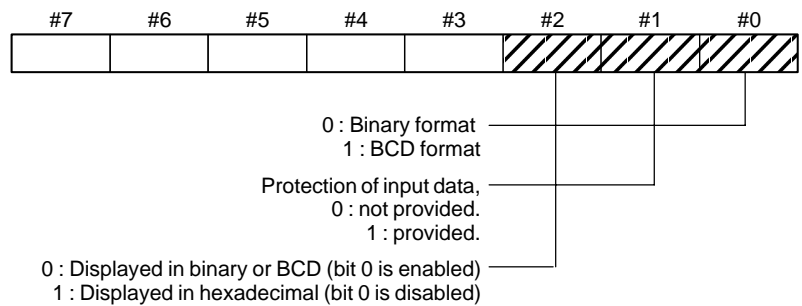

«TYPE»

- 0 : 1byte
- 1 : 2bytes
- 2 : 4bytes

2) Data setting screen (G. DATA)

Group number
Number of page

PMC PRM (DATA) 001/001 MONIT RUN

| NO. | ADDRESS | DATA |
|-----|---------|------|
| 000 | D0000 | 0 |
| 001 | D0001 | 0 |
| 002 | D0002 | 0 |
| 003 | D0003 | 0 |
| 004 | D0004 | 0 |
| 005 | D0005 | 0 |
| 006 | D0006 | 0 |
| 007 | D0007 | 0 |
| 008 | D0008 | 0 |
| 009 | D0009 | 0 |

[C.DATA] [G-SRCH] [SEARCH] [] [] []

- (a) [C.DATA] soft key : Return to data table setting screen.
- (b) Group No. [G-SRCH] : Move the cursor to head of specified group.
- (c) Address [SEARCH] : Searching the specified address in currentup group.

4.3.4.6
Setting screen

Some PMC system parameters can be set on this screen.

| PMC PRM (SETTING) | MONIT RUN | |
|-----------------------|-----------|--|
| SIGNAL TRACE START | = | <input type="checkbox"/> (0:MANUAL 1:AUTO) (K17.5) |
| SIGNAL TRIGGER START | = | <input type="checkbox"/> (0:MANUAL 1:AUTO) (K18.2) |
| EDIT ENABLE | = | <input type="checkbox"/> (0:NO 1:YES) (K18.6) |
| WRITE TO F-ROM (EDIT) | = | <input type="checkbox"/> (0:NO 1:YES) (K19.0) |
| RAM WRITE ENABLE | = | <input type="checkbox"/> (0:NO 1:YES) (K17.4) |
| DATA TBL CNTL SCREEN | = | <input type="checkbox"/> (0:YES 1:NO) (K17.7) |
| HIDE PMC PARAM | = | <input type="checkbox"/> (0:NO 1:YES) (K19.6) |
| PROTECT PMC PARAM | = | <input type="checkbox"/> (0:NO 1:YES) (K19.7) |
| HIDE PMC PROGRAM | = | <input type="checkbox"/> (0:NO 1:YES) (K17.0) |
| LADDER START | = | <input type="checkbox"/> (0:AUTO 1:MANUAL) (K17.2) |
| } | | |

| | | | | | |
|---------------------------------|-------------------------------|--------------------------|--------------------------|--------------------------|--------------------------|
| <input type="checkbox"/> MANUAL | <input type="checkbox"/> AUTO | <input type="checkbox"/> | <input type="checkbox"/> | <input type="checkbox"/> | <input type="checkbox"/> |
|---------------------------------|-------------------------------|--------------------------|--------------------------|--------------------------|--------------------------|

| PMC PRM (SETTING) | MONIT RUN | |
|-------------------|-----------|--|
| ALLOW PMC STOP | = | <input type="checkbox"/> (0:NO 1:YES) (K19.2) |
| PROGRAMMER ENABLE | = | <input checked="" type="checkbox"/> (0:NO 1:YES) (K17.1) |
| } | | |

| | | | | | |
|-----------------------------|------------------------------|--------------------------|--------------------------|--------------------------|--------------------------|
| <input type="checkbox"/> NO | <input type="checkbox"/> YES | <input type="checkbox"/> | <input type="checkbox"/> | <input type="checkbox"/> | <input type="checkbox"/> |
|-----------------------------|------------------------------|--------------------------|--------------------------|--------------------------|--------------------------|

NOTE

The parenthesized values to the right of the screen indicate keep relay addresses.

4.3.5 Input/Output of PMC Data

4.3.5.1 Start of the built-in type PMC programmer

* As following operation is not required when the data set from MDI.

- 1 Select the PMC screen

Press  key and press [PMC] soft key.

- 2 Confirm to the built-in type PMC programmer is running.

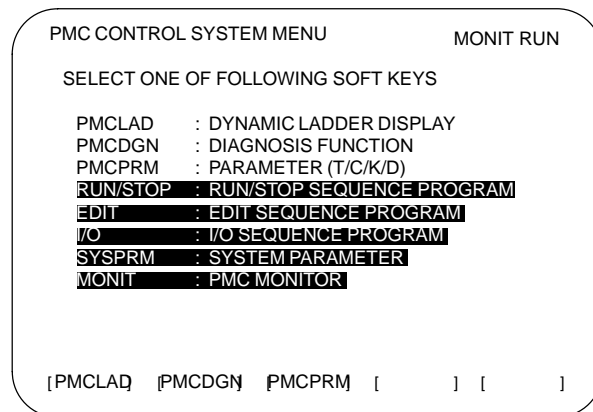

 parts are displayed, starts of the built-in type PMC programmer.

- 3 Keep relay K17.1 should set to “1” if the built-in type PMC programmer is not start yet.

- 4 Press  key to return to initial menu screen.

4.3.5.2 Input/output method

- 1 Press  key in the initial menu screen, then display to [I/O] soft key.

- 2 Display next screen

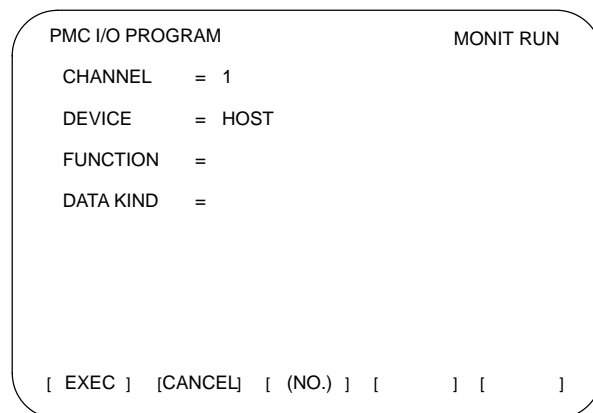

- 3 Enter the desired channel number, then press the  key to set the number for CHANNEL.

1 : JD5A of the main CPU board

2 : JD5B of the main CPU board

-
- 4 Specify the I/O unit to be used for DEVICE.
 - HOST: I/O operation with FAPT LADDER (on the P-G, P-G Mate, or personal computer)
 - FDCAS: I/O operation with a Floppy Cassette Adaptor
 - F-ROM: I/O operation with a flash EEPROM
 - M-CARD: I/O operation with a memory card
 - OTHERS: I/O operation with other I/O units
 - 5 Specify the desired function with FUNCTION.
 - WRITE: Outputting data
 - READ: Inputting data
 - COMPARE: Comparing data in memory with that in an external device
 - DELETE: Deleting files on a floppy disk or memory card
 - LIST: Listing the files on a floppy disk or memory card
 - BLANK: Checking whether the flash EEPROM is empty
 - ERASE: Clearing the data in the flash EEPROM
 - FORMAT: Formatting a memory card (all data on the memory card is deleted.)
 - 6 Specify the desired type of data to be output at KIND DATA.
 - LADDER: Ladder programs
 - PARAM: PMC parameters
 - 7 When FDCAS or M-CARD is specified for the device, a file can be specified for FILE NO. by either its file number or file name.
 - 8 Specify the RS-232C conditions for each device with SPEED.
 - 9 Check that the settings are correct. Then, press the [EXEC] soft key.

4.3.5.3 Copy function (COPY)

Changes made during on-line editing are transferred to the corresponding editing ladder program.

4.3.6 System Parameters

(1) System parameter screen (1/2)

| | | |
|----------------------------|-----|---------------------|
| PMC SYSTEM PARAMETER (1/2) | | MONIT STOP |
| COUNTER DATA TYPE | = | BINARY / BCD |
| } | | |
| | | |
| BINARY | BCD | |
| | | |

Display information

- COUNTER DATA TYPE :
Specify the binary format or BCD format for a counter value to be used with the function instruction CTR.

(2) System parameter screen (2/2)

| | | |
|----------------------------|----|--------------------|
| PMC SYSTEM PARAMETER (2/2) | | MONIT STOP |
| FS0 OPERATOR PANEL | = | YES / NO |
| KEY DI ADDRESS | = | $\overline{X0100}$ |
| LED DO ADDRESS | = | $\overline{Y0100}$ |
| KEY BIT IMAGE ADDRESS | = | $\overline{R0900}$ |
| LED BIT IMAGE ADDRESS | = | $\overline{R0910}$ |
| } | | |
| | | |
| YES | NO | |
| | | |

Display information

- FS0 OPERATOR PANEL :
Set whether to connect an operator's panel for the FS0.
- KEY DI ADDRESS :
Set the start address of an external DI actually connected.

- LED DO ADDRESS :
Set the start address of an external DO actually connected.
- KEY BIT IMAGE ADDRESS :
Set the start address of a key image referenced by a user program. Usually, set an arbitrary internal relay (R) area.
- LED BIT IMAGE ADDRESS :
Set the start address of an LED image generated by a user program. Usually, set an arbitrary internal relay (R) area.

4.3.7 Online Monitor Setting Screen

| PARAMETERS FOR ONLINE MONITOR MONIT RUN | | | | | | | | |
|--|---|-------------------------|----------------|------|--|--|--------|------|
| CPU ID | = | | | | | | | |
| RS-232C | = | USE/ | NOT USE | | | | | |
| CHANNEL | = | | 1 | | | | | |
| BAUD RATE | = | 300/600/1200/2400/4800/ | 9600/19200 | | | | | |
| PARITY | = | NONE /ODD/EVEN | | | | | | |
| STOP BIT | = | 1 BIT/ | 2 BITS | | | | | |
| RS-232C | = | INACTIVE | : 0 | | | | | |
| HIGH SPEED I/F | = | STAND-BY | : 0 | | | | | |
| } | | | | | | | | |
| <table border="1" style="width:100%; text-align:center;"> <tr> <td style="width:25%;"></td> <td style="width:25%;"></td> <td style="width:25%;"></td> <td style="width:25%;">EMG ST</td> <td style="width:25%;">INIT</td> </tr> </table> | | | | | | | EMG ST | INIT |
| | | | EMG ST | INIT | | | | |

(a) Soft key

- [EMG ST] : Terminates communication forcibly. Use this key if communication becomes abnormal and the connection cannot be terminated normally.
- [INIT] : Initializes the parameters to their default values.

(b) Setting

- CPU ID : Displays a CPU ID value. However, do not modify this item.
- RS-232C : Enables communication setting in the case of connection via RS-232C. However, do not modify the items of TIMER 1, TIMER 2, TIMER 3, and MAX PACKET SIZE.
- HIGH SPEED I/F : Enables setting for connection via a high-speed interface (HSSB, Ethernet).

NOTE

- 1 When both "RS-232C = USE" and "HIGH SPEED I/F = USE" are selected, the PMC system will communicate with the application which is connected at first. If PMC system is already connecting with an application, it can not connect with other applications.
- 2 When you use the online function by Ethernet, the setting of Ethernet parameters at CNC is necessary in advance.

(c) Communication status

- USE TIME : The maximum time in the communication processing is displayed.
- RS-232C : The communication condition of RS-232C is displayed.
- HIGH SPEED I/F : The communication condition of HIGH SPEED I/F is displayed.
- ETHER_BOARD : Displayed during the communication with Ethernet board. The IP address of the communication partner is displayed.
- EMB_ETHERNET: Displayed during the communication with embedded Ethernet. The IP address of the communication partner is displayed.
- HSSB : Displayed during the communication with HSSB.

Display messages and the meanings

| Display messages | Meanings |
|-------------------------|--|
| INACTIVE | The communication is inactive. |
| STOPPING | The communication is being stopped. (Wait for the termination of communication) |
| STARTING | The communication is being started. (Wait for the termination of communication over another communication path) |
| STAND-BY | The communication is active and in standby mode. |
| CONNECTED | The communication is active and being connected. |
| NO OPTION | The port can be not opened because there is not option of RS-232C. |
| BAD PARAMETER | Invalid open parameters are specified. |
| TIMEOUT ERROR | A time-out has occurred and communication is aborted. |
| TIMEOUT(K) ERROR | A time-out has occurred and communication is aborted. |
| BCC ERROR | A Block Check Code (packet parity) error has occurred. |
| PARITY ERROR | A parity error has occurred. |
| OVER-RUN ERROR | A reception overrun has occurred and the communication can not recover. |
| SEQUENCE ERROR | Packets are out of sequence. (Incorrect procedure) |
| DATA ERROR | Incorrect packets have been received through retry process. |
| QUEUE OVERFLOW | The transmit/receive queue has overflowed. |
| DISCONNECTED | Communication has been terminated successfully. |
| NO CONNECTION | The cable is disconnected. |

4.4 PMC SCREEN (PMC-SB7)

4.4.1 PMC Menu Selection Procedure Using Soft Keys

PMC-SB7 screen menu selection procedure

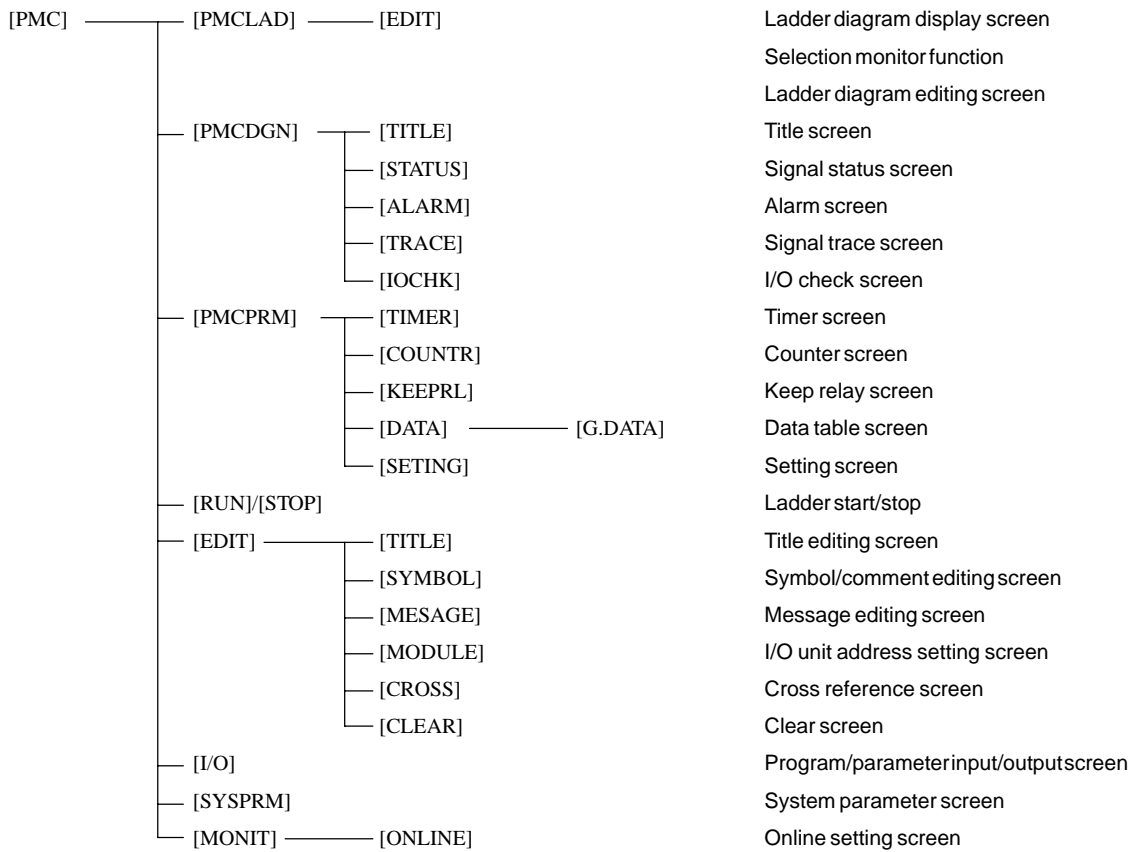

4.4.2 Dynamic Display of Sequence Programs

(1) Display method

- <1> Press the system key, then press the [PMC] soft key.
- <2> Press the [PMCLAD] soft key to enable dynamic display of sequence programs.

(2) Display information

The ladder diagram display/editing function consists of the following screens:

- a) Ladder diagram display screen
- b) Selection monitor screen
- c) Ladder diagram editing screen
- d) Net editing screen
- e) Program list display screen
- f) Program list editing screen

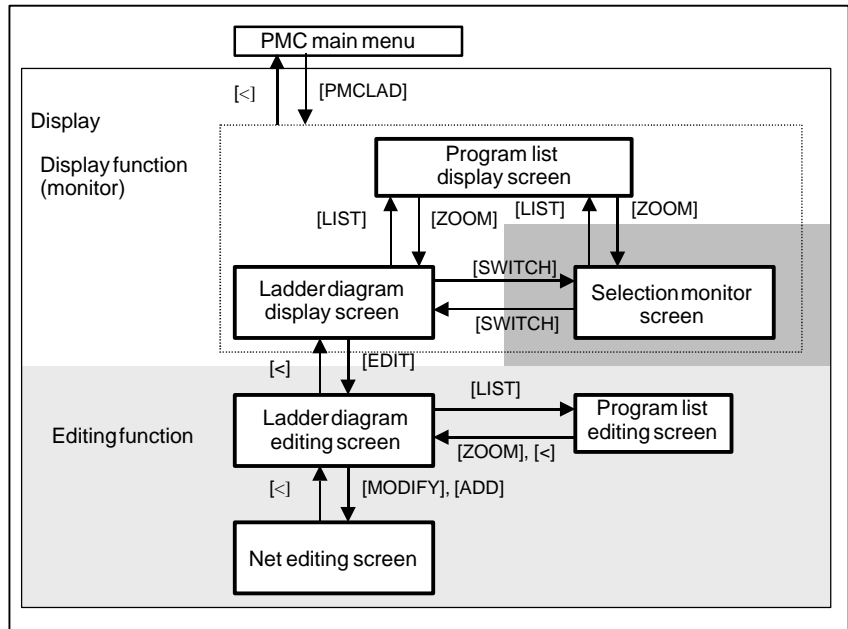

4.4.2.1 Ladder diagram display screen

(1) Screen configuration

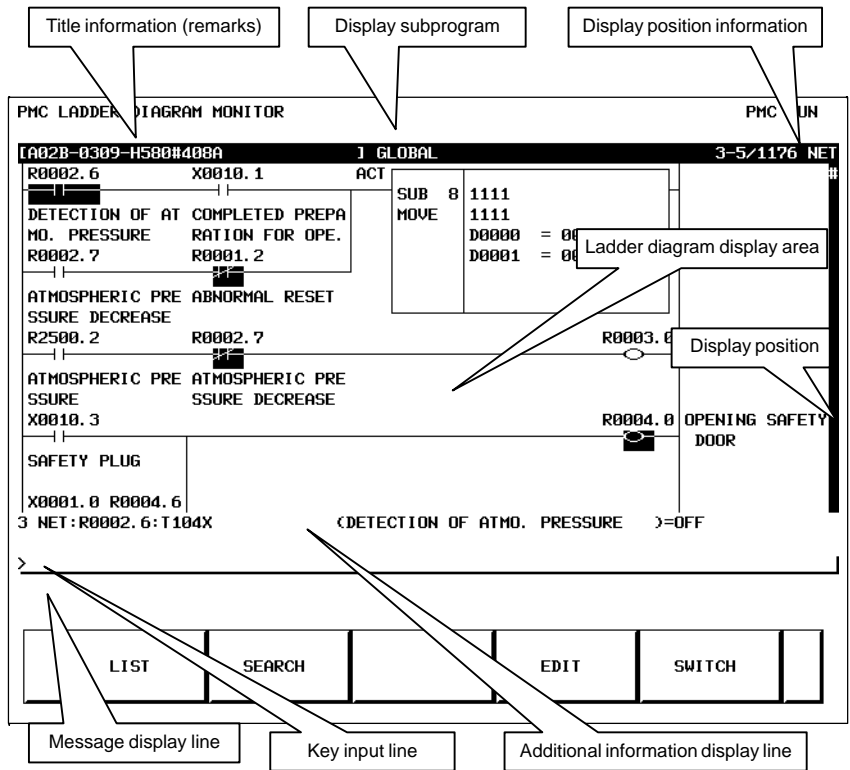

(2) Calling the program list display screen [LIST]



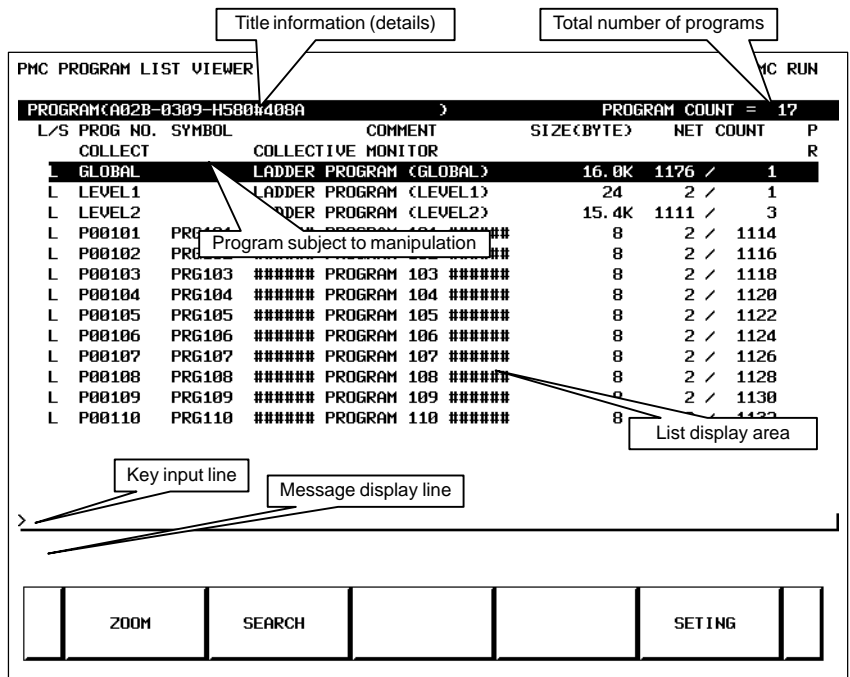

The program list display screen allows you to select a subprogram to be displayed on the ladder diagram display screen.



(3) Searching for a signal [SEARCH]

<1> Press the [SEARCH] soft key.

<2> Search for a signal by using the keys indicated below.

- With    , the display area can be changed.
- [TOPBTM] : The start/end of a ladder diagram is searched for.
- “Address” + [SEARCH] or “Signal name” + [SEARCH]:
A specified address or signal name is searched for.
- “net-number” + [SEARCH]:
A ladder is displayed from a specified net number.
- “Address” + [W-SRCH] or “Signal name” + [W-SRCH]:
The write coil is searched for a specified address or signal name.
- “function-instruction-number” + [F-SRCH] or
“function-instruction-name” + [F-SRCH]:
A specified function instruction is searched for.
- [PREV] : The previous search operation performed successfully is repeated towards the start.
- [NEXT] : The previous search operation performed successfully is repeated towards the end.
- [GLOBAL]/[LOCAL] : The search range is switched.

(4) Calling the function instruction data table display screen [TABLE]

The data table of a function instruction with a data table such as the COD instruction (SUB7) and the CODB instruction (SUB27) can be displayed.

(5) Setting the screen [SETTING]

The setting screen for the ladder diagram display screen can be called. Various settings for ladder diagram display can be modified.

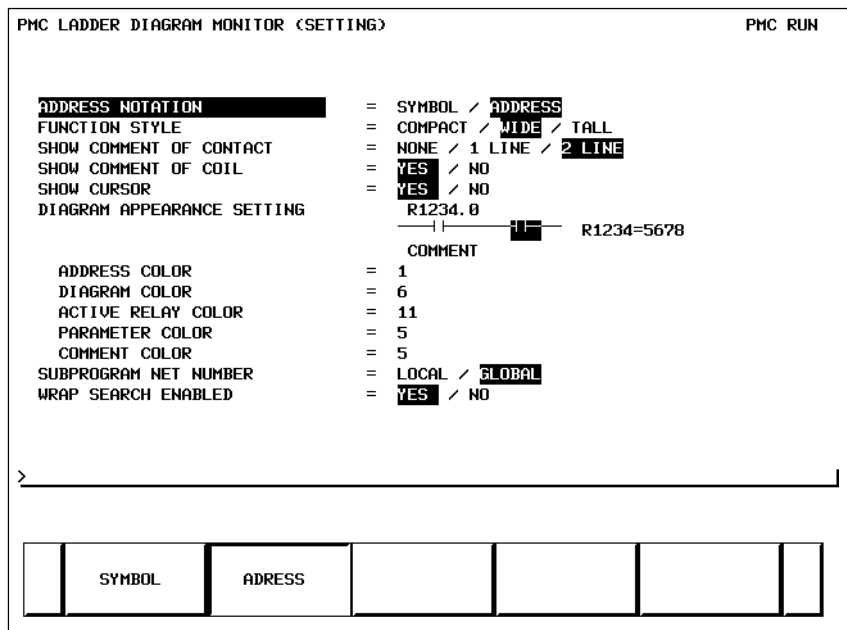

4.4.2.2 Selection monitor screen

On the selection monitor screen, only a ladder net including a coil to be monitored can be specified for ladder net monitoring.

(1) Display method

(a) Calling the screen from the program list display screen

- <1> Display the program list screen.
- <2> Move the cursor to the "COLLECT".
- <3> Press the [ZOOM] soft key.

(b) Calling the screen from the ladder diagram display screen

- <1> Display the ladder diagram display screen.
- <2> Press the [SWITCH] soft key.

(2) Display information

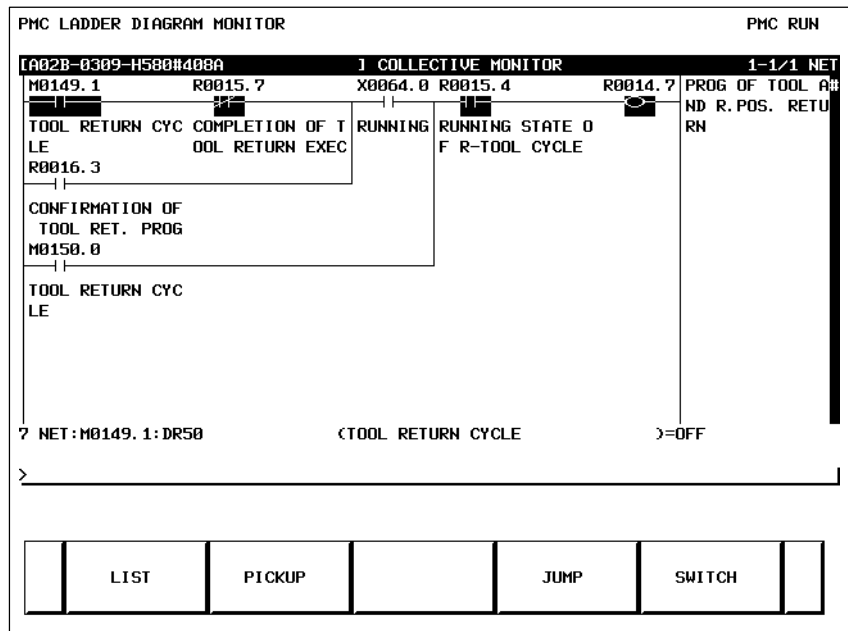

(3) Specifying a ladder net to be monitored [PICKUP]

By using the method described below, a ladder net to be monitored on the selection monitor screen can be read for display.

(a) Specifying a desired ladder net on the selection monitor screen

- Typing the address used with the coil to read the net
 - <1> Enter the address to be monitored.
 - <2> Press the [PICKUP] soft key.
 - <3> The net that uses the address specified by <1> with a coil is read to the top of the screen.
- Specifying the ladder net on the selection monitor screen
 - <1> Move the cursor to the relay in the ladder net that uses an address to be monitored.
 - <2> Press the [PICKUP] soft key.
 - <3> The net that uses the address specified by <1> with a coil is read to the top of the screen, and the cursor moves to the coil position.

- (b) Specifying a desired ladder net on the ladder diagram display screen
 - <1> Press the [SEARCH] soft key on the ladder diagram display screen.
 - <2> Move the cursor to the ladder net to be read.
 - <3> Press the [PICKUP] soft key.
- (4) Jumping to a ladder diagram on the ladder diagram display screen [JUMP]

Make a jump by finding, on the ladder diagram display screen, the ladder net where the cursor is placed on the selection monitor screen.

 - <1> Move the cursor to the net to which you want to jump.
 - <2> Press the [JUMP] soft key.
- (5) Switching to the ladder diagram display screen [SWITCH]

The screen display can be switched to the ladder diagram display screen.
- (6) Deleting the display of one ladder diagram net [ERASE]

One ladder net read into the selection monitor screen can be erased from the screen.
- (7) Deleting the display of all ladder diagram nets [ERALL]

All ladder nets read into the selection monitor screen can be erased from the screen.

4.4.2.3 Ladder diagram editing screen

On the ladder diagram editing screen, a ladder diagram can be edited to change its operation.

- (1) Display method
 - <1> Display the ladder diagram monitor display screen by pressing the [PMCLAD] soft key.
 - <2> Press the [EDIT] soft key.
- (2) Display information

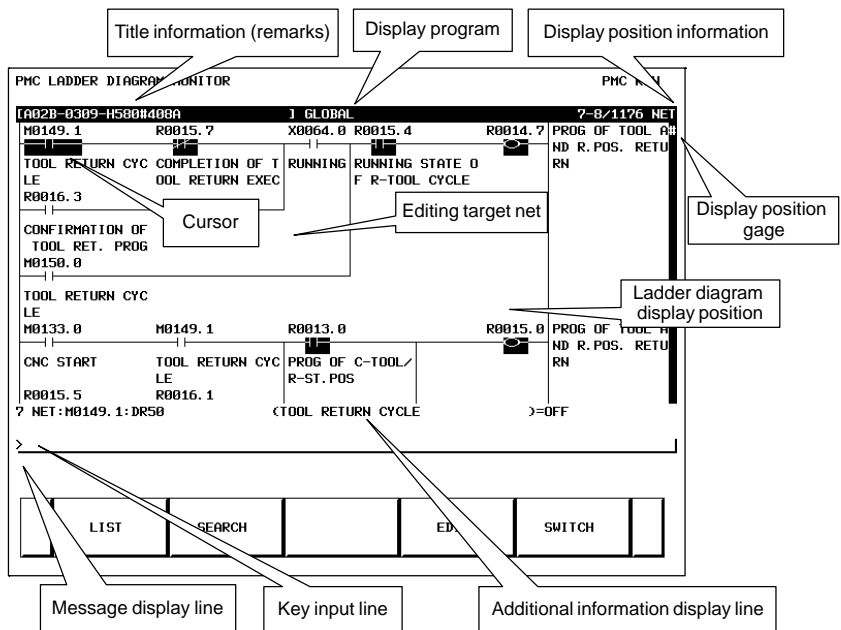

(3) Editing ladder programs

By using the keys below, a ladder diagram can be edited.

- Selecting a subprogram to be edited
 - <1> Display the program list editing screen by pressing the [LIST] soft key.
 - <2> Move the cursor to a subprogram to be edited.
- Searching for a specified address or function instruction
 - <1> Press the [SEARCH] soft key.
 - <2> Switch to the soft key display for search.

For the search function, see “(3) Searching for a signal [SEARCH]” in Subsection 4.4.2.1, “Ladder diagram display screen”.
- Adding a new net
 - <1> Move the cursor to the position where a new net is to be added.
 - <2> Press the [CREATE] soft key to call the net editing screen. Perform creation and addition operations to build a new net.
- Modifying the structure of a selected net
 - <1> Move the cursor to a net to be modified.
 - <2> Call the net editing screen by pressing the [MODIFY] soft key.
- Changing the bit address of a relay
 - <1> Move the cursor to a relay to be modified.
 - <2> Enter a desired bit address then press the INPUT key. The bit address of the relay where the cursor is placed is changed.
- Modifying the parameter of a function instruction
 - <1> Move the cursor to the parameter of a function instruction to be modified.
 - <2> Enter a desired number or byte address then press the INPUT key. The parameter of the function instruction where the cursor is placed is modified.
- Reflecting modifications
 - <1> On the ladder diagram editing screen, modify a ladder program.
 - <2> Press the [UPDATE] soft key. The results of editing performed so far are reflected in the ladder being executed. When the modifications have been reflected normally, the ladder after editing is executed.
- Deleting a net
 - <1> Move the cursor to a net to be deleted.
 - <2> Press the [DELETE] soft key.
- Moving a net
 - <1> Move the cursor to a net to be moved.
 - <2> By pressing the [CUT] soft key, cut the net.
 - <3> Move the cursor to the position to which the selected net is to be moved.
 - <4> Press the [PASTE] soft key.

- Copying a net
 - <1> Move the cursor to a net to be copied.
 - <2> Press the [COPY] soft key.
 - <3> Move the cursor to the position to which the selected net is to be copied.
 - <4> Press the [PASTE] soft key.
- Selecting multiple nets to be deleted/copied/moved
 - <1> Move the cursor to the start point of a desired net selection range.
 - <2> Press the [SELECT] soft key.
 - <3> Move the cursor to the end point of the desired net selection range.
 - <4> Press the [DELETE], [CUT], or [COPY] soft key to delete, move, or copy the selected nets.
- Discarding changes

Press the [RESTOR] soft key.

The results of editing performed so far are discarded to return to the ladder present when you moved to the ladder diagram editing screen or when you performed the last [UPDATE] processing.
- Modifying the setting of the ladder diagram editing screen

Press the [SETTING] soft key.

The setting screen of the ladder diagram editing screen is called.
- Starting/stopping a ladder

Press the [RUN] or [STOP] soft key.

The execution of a ladder program is controlled. The [RUN] soft key starts the execution of a ladder program, and the [STOP] soft key stops the execution of a ladder program.
- Ending the editing

Press the [<] key.

4.4.2.4 Net editing screen

On the net editing screen, net editing operations such as the creation of a new net and the modification of an existing net can be performed.

- Modification to an existing net

If the net editing screen is displayed with the [MODIFY] soft key, the mode (modification mode) for modifying the net indicated by the cursor is set.
- Addition of a new net

If the net editing screen is displayed with the [CREATE] soft key, the mode (creation mode) for creating a new net from a free state is set.

(1) Display method

- <1> Display the ladder diagram editing screen.
- <2> Press the [CREATE] or [MODIFY] soft key.

(2) Display information

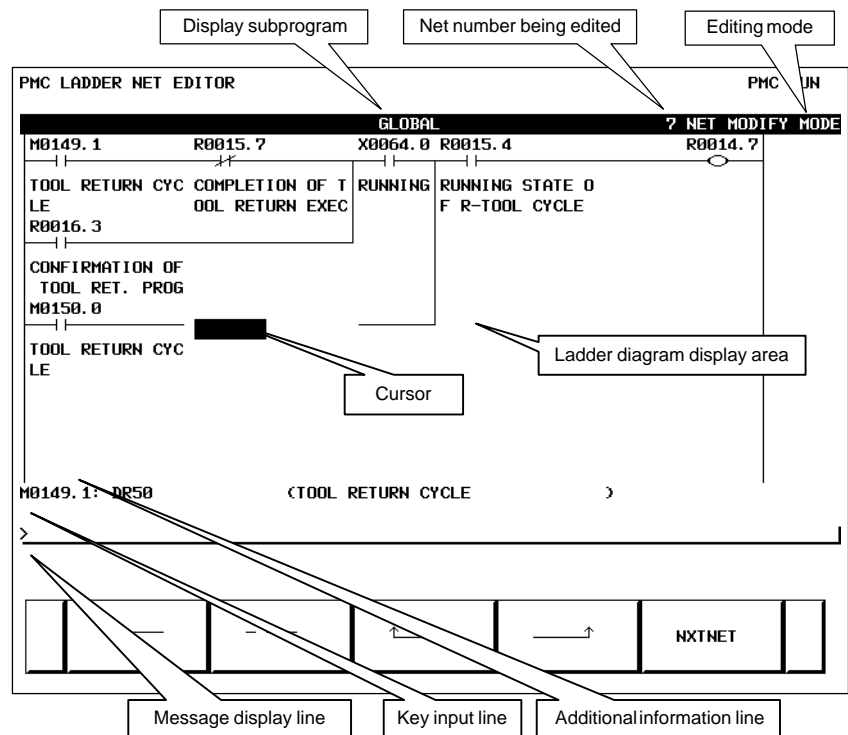

(3) Editing nets

By using the keys indicated below, a new net can be created, and an existing net can be modified.

- Placing a new contact or coil
 - <1> Move the cursor to the position where a new contact or coil is to be placed.
 - <2> Enter a bit address, then press a soft key such as [—|—|], [—○—].
- Changing the type of a contact or coil
 - <1> Move the cursor to the position where the type of a contact or coil is to be changed.
 - <2> Press a soft key such as [—|—|], [—○—].
- Changing the address of a contact or coil
 - <1> Move the cursor to a relay to be modified.
 - <2> Enter a bit address, then press the INPUT key.
- Placing a new function instruction
 - <1> Move the cursor to the position where a new function instruction is to be placed.
 - <2> Enter a function instruction number, then press the [FUNC] soft key.
- Changing the type of a function instruction
 - <1> Move the cursor to a function instruction to be modified.
 - <2> Enter a function instruction number.

- Changing the parameter of a function instruction
 - <1> Move the cursor to the parameter of a function instruction to be modified.
 - <2> Enter a number or byte address, then press the INPUT key.
- Adding/deleting a connection line
 - <1> Move the cursor to the position where a connection line is to be added or deleted.
 - <2> Press a soft key such as [————], [↑————], [————↑] for addition.
 - <3> When deleting an existing connection line, press a soft key such as [··········], [↑————], [————↑].
- Deleting a contact, coil, or function instruction
 - <1> Move the cursor to the position where a contact, coil, or function instruction to be deleted is located.
 - <2> Press the [··········] soft key.
- Editing the next net

Press the [NXTNET] soft key. The editing operation of the net currently being edited ends, and processing proceeds to the editing of the next net.
- Editing a function instruction data table
 - <1> Move the cursor to the function instruction that has a data table to be edited.
 - <2> Press the [TABLE] soft key. The function instruction data table editing screen appears.
 - <3> Move the cursor to the data table to be edited.
 - <4> Modify the selected data.
- Inserting a line/column
 - <1> Move the cursor to the position where a line/column is to be inserted.
 - <2> Press the [INSLIN], [INSCLM], or [APPCLM] soft key.
- Discarding the results of editing

Press the [RESTOR] soft key.

4.4.3 Display of the PMC Diagnosis Screen

Display method

- <1> Press the system key, then press the [PMC] soft key.
- <2> Press the [PMCDGN] soft key. The PMC diagnosis screen appears.

4.4.3.1 Title screen

The title data registered at the time of ladder program creation is displayed.

```

PMC TITLE DATA #1 (LADDER)          PMC RUN
PMC PROGRAM NO.   :   0001
EDITION NO.      :    06
PMC CONTROL PROGRAM
SERIES:408A EDITION:01

PMC TYPE CONTROL: SB7  PROGRAM : SB7
MEMORY USED   : 108.0 KB
LADDER        : 016.0 KB
SYM&CMT       : 092.0 KB
MESSAGE       : 000.0 KB
SCAN TIME     : 008  MS
SCAN MAX      : 008 MS  MIN : 008 MS
  
```

| | | | | |
|-------|--------|-------|-------|--|
| TITLE | STATUS | ALARM | TRACE | |
|-------|--------|-------|-------|--|

Title data is the title of a sequence program, and consists of ten items:

- MACHINE TOOL BUILDER NAME (32 characters)
- MACHINE TOOL NAME (32 characters)
- CNC & PMC TYPE NAME (32 characters)
- PMC PROGRAM NO. (4 characters)
- EDITION NO. (2 characters)
- PROGRAM DRAWING NO. (32 characters)
- DATE OF PROGRAMMING (16 characters)
- PROGRAM DESIGNED BY (32 characters)
- ROM WRITTEN BY (32 characters)
- REMARKS (32 characters)

In addition, the following data is displayed:

- Series and edition of the PMC basic software
- Memory use status of each sequence data item
- Type of the PMC basic software and the PMC type of the sequence program
- Current execution time, maximum execution time, and minimum execution time of the ladder program

4.4.3.2
Status screen



The on/off state of I/O signals and the internal relay is displayed.

| PMC SIGNAL STATUS | | | | | | | PMC RUN | |
|--|------|------|--------|--------|------|------|---------|------|
| ADDRESS | 7 | 6 | 5 | 4 | 3 | 2 | 1 | 0 |
| G0000 | . | . | . | . | . | . | . | . |
| G0001 | . | . | . | . | . | . | . | . |
| G0002 | . | . | . | . | . | . | . | . |
| G0003 | . | . | . | . | . | . | . | . |
| G0004 | . | . | MFIN3M | MFIN2M | FIN | . | . | . |
| G0005 | BFIN | . | . | . | TFIN | SFIN | . | MFIN |
| G0006 | . | . | . | . | . | . | . | . |
| G0007 | . | EXLM | *FWUP | . | . | ST | . | . |
| [G0005.0 : MFIN : M COMMAND FINISH [HIGH SPEED]] | | | | | | | | |

Signal state
(period): Off
I: On

Signal name

SEARCH FORCE

- The diagnosis number can be increased or decreased by using   .
- Enter an address and number or signal name, then press the [SEARCH] soft key. Then, the specified address or signal name is searched for.

4.4.3.3
Alarm screen

An alarm issued from the PMC is displayed.

| PMC ALARM MESSAGE | | | | PMC RUN |
|-------------------|--------|-------|-------|---------|
| ALARM NOTHING | | | | |
| TITLE | STATUS | ALARM | TRACE | |

4.4.3.4
Trace function

(1) Trace parameter screen (first page)

- <1> Press the system key, then press the [PMC] soft key.
- <2> Press the [PMCDGN] soft key.
- <3> Press the [TRACE] soft key.
- <4> Press the [SETTING] soft key on the signal trace screen.

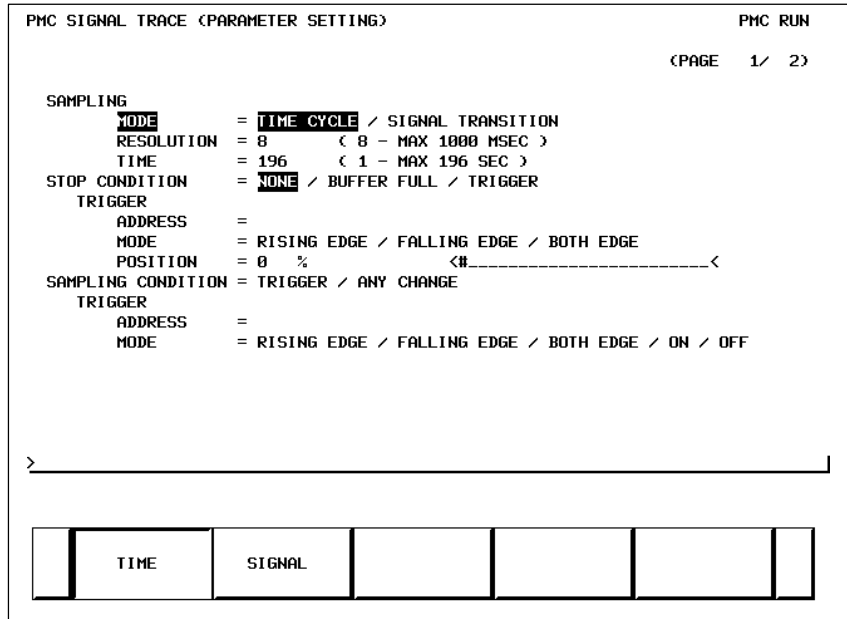

- a) SAMPLING/MODE
Set a sampling mode.
 - TIME CYCLE : Sampling based on a period of time
 - SIGNAL TRANSITION : Sampling based on signal transitions
- b) SAMPLING/RESOLUTION
Set the resolution of sampling.
- c) SAMPLING/TIME
This item is displayed when “TIME CYCLE” is selected as the sampling mode. Set a time interval for sampling.
- d) SAMPLING/FRAME
This item is displayed when “SIGNAL TRANSITION” is selected as the sampling mode. Set the number of sampling times.
- e) STOP CONDITION
Set a trace stop condition.
 - NONE : Does not stop trace operation automatically.
 - BUFFER FULL : Stops trace operation automatically when the sampling buffer becomes full.
 - TRIGGER : Stops trace operation automatically by a trigger.

- f) **STOP CONDITION/TRIGGER/ADDRESS**
This item becomes settable when “TRIGGER” is set as the trace stop condition. Set a trigger address for stopping trace operation.
- g) **STOP CONDITION/TRIGGER/MODE**
This item becomes settable when “TRIGGER” is set as the trace stop condition. Set a trigger mode for stopping trace operation.
- **RISING EDGE** : Stops trace operation automatically on the rising edge of the trigger signal.
 - **FALLING EDGE** : Stops trace operation automatically on the falling edge of the trigger signal.
 - **BOTH EDGE** : Stops trace operation automatically on a transition of the trigger signal.
- h) **STOP CONDITION/TRIGGER/POSITION**
This item becomes settable when “TRIGGER” is set as the trace stop condition. By using a ratio to the sampling time (or count), set where to place a stop trigger occurrence position in the entire sampling time (or count).
- i) **SAMPLING CONDITION**
This item becomes settable when “SIGNAL TRANSITION” is set as the sampling mode. Set a sampling condition.
- **TRIGGER** : Performs sampling when the sampling trigger condition is satisfied.
 - **ANY CHANGE** : Perform sampling when a sampling address signal transition occurs.
- j) **SAMPLING CONDITION/TRIGGER/ADDRESS**
This item becomes settable when “SIGNAL TRANSITION” is set as the sampling mode and “Trigger” is set as the sampling condition. Set an address used to trigger sampling.
- k) **SAMPLING CONDITION/TRIGGER/MODE**
This item becomes settable when “SIGNAL TRANSITION” is set as the sampling mode and “Trigger” is set as the sampling condition. Set a trigger condition mode.
- **RISING EDGE** : Performs sampling on the rising edge of the trigger signal.
 - **FALLING EDGE** : Performs sampling on the falling edge of the trigger signal.
 - **BOTH EDGE** : Performs sampling on a signal transition.
 - **ON** : Performs sampling when the trigger signal is on.
 - **OFF** : Performs sampling when the trigger signal is off.

(2) Trace parameter screen (second page)

On the trace parameter screen (first page), press

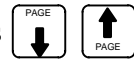

| PMC SIGNAL TRACE (PARAMETER SETTING) | | | | | | PMC RUN | | | | | | | |
|---|---------|---|----|---------|---------|--------------|----|--|--|--|--------|---------|--|
| | | | | | | (PAGE 2 / 2) | | | | | | | |
| SAMPLING ADDRESS | | | | | | | | | | | | | |
| 1 | T8MS | * | 9 | R9091.0 | * | 17 | 25 | | | | | | |
| 2 | T16MS | * | 10 | R9091.1 | * | 18 | 26 | | | | | | |
| 3 | T32MS | * | 11 | R9091.5 | * | 19 | 27 | | | | | | |
| 4 | T64MS | * | 12 | R9091.6 | * | 20 | 28 | | | | | | |
| 5 | T128MS | * | 13 | R9091.2 | * | 21 | 29 | | | | | | |
| 6 | T256MS | * | 14 | R9091.3 | * | 22 | 30 | | | | | | |
| 7 | T512MS | * | 15 | R9091.4 | * | 23 | 31 | | | | | | |
| 8 | T1024MS | * | 16 | R9091.7 | * | 24 | 32 | | | | | | |
| [R9200.3 : T8MS : 8MS TIMER] | | | | | | | | | | | | | |
| <table border="1" style="width:100%; border-collapse: collapse;"> <tr> <td style="width:15%;"></td> <td style="width:15%;"></td> <td style="width:15%;"></td> <td style="width:15%;"></td> <td style="width:15%; text-align: center;">DELETE</td> <td style="width:15%; text-align: center;">ADDRESS</td> <td style="width:15%;"></td> </tr> </table> | | | | | | | | | | | DELETE | ADDRESS | |
| | | | | DELETE | ADDRESS | | | | | | | | |

a) Address setting

Set a signal address as a bit address. If you enter a byte address, bits 0 to 7 of the entered address are input. Up to 32 signal addresses can be set.

b) Soft keys

- [DELETE] : Deletes the set address where the cursor is placed.
- [SYMBOL]/[ADDRESS]: Switches the setting address between symbol display and address display.
- [MV.UP] : Replaces the set address with the upper line.
- [MV.DWN] : Replaces the set address with the lower line.
- [DELALL] : Deletes all set addresses.

c) Trigger setting

When “SIGNAL TRANSITION” is set as the trace sampling mode and “BOTH EDGE” is set as the sampling condition, you can choose whether to use a set address as a trigger signal for sampling. To the right of a signal address set as a trigger, a “●” mark is indicated.

- [TRGON] : Turns on a trigger setting.
- [TRGOFF] : Turns off a trigger setting.

(3) Trace screen

<1> Press the system key, then press the [PMC] soft key.

<2> Press the [PMCDGN] soft key.

<3> Press the [TRACE] soft key.

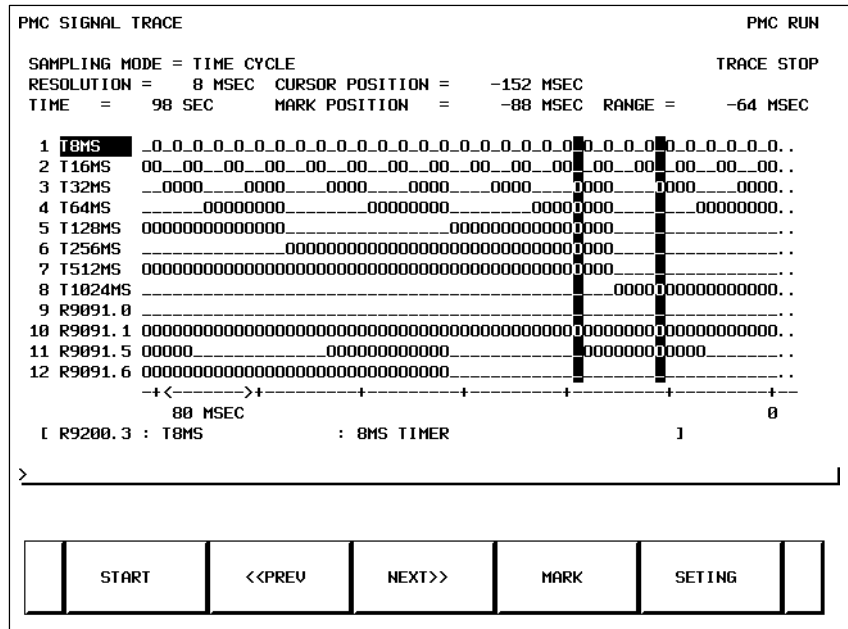

(a) Executing trace operation

[START] : Executes trace operation.

(b) Stopping trace operation

[STOP] : Stops trace operation. Trace operation ends also when the trace stop condition set on the trace parameter setting screen is satisfied.

(c) Checking trace results

Upon completion of trace execution, the results of trace operation can be checked.

- Scrolling display

Cursor up/down key, page switch key:

Scrolls the set sampling signal addresses up and down.

[<<PREV], [NEXT>>] Soft key, current right/left key:

Scrolls the graphical display of trace results right and left.

- Performing automatic calculation and display of a selected range

[MARK] : Marks the current cursor position, and displays the mark cursor. To cancel the range selection, press the [MARK] soft key again.

- Enlarging/reducing display of trace results

[Z.IN]/[Z.OUT] : Enlarges/reduces graphical display.

- Replacing display data
 - [MV.UP] : Replaces the address where the cursor is placed and the trace result of the address with the upper line.
 - [MV.DWN] : Replaces the display data with the lower line.

4.4.3.5 I/O Link connection check screen

The type and ID code of an I/O device connected to the I/O Link are displayed for each group. No data is displayed when no I/O device is connected.

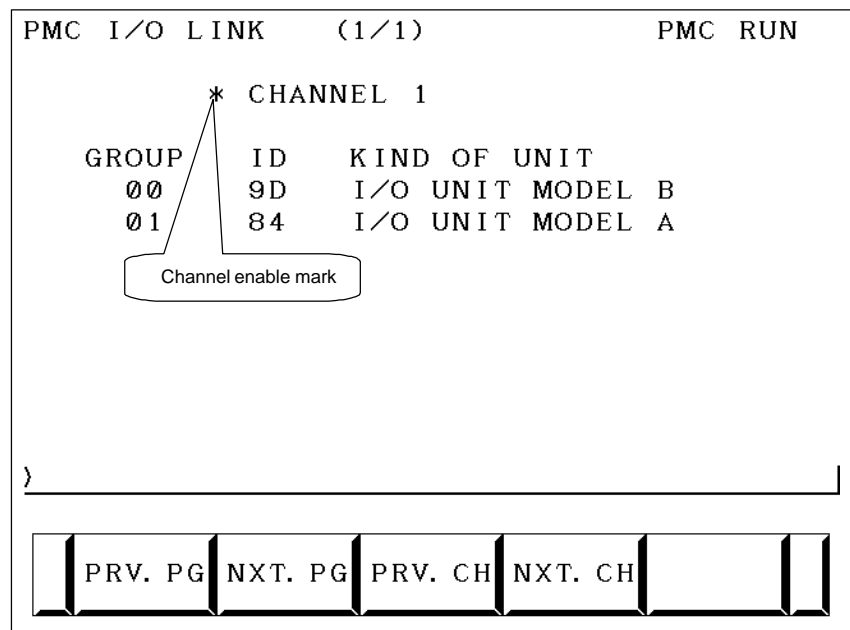

Channel enable mark : When a channel is usable, an “*” mark is indicated. On the sample screen above, channel 2 is unusable.

4.4.4 PMC Parameters

4.4.4.1 Parameter input/output method

- <1> Place the NC in the MDI mode or in the emergency stop state.
- <2> Set PWE of the NC setting screen to 1.

| | PWE | KEY4 | |
|------------|-----------------------|-----------------------|------------|
| Timer | <input type="radio"/> | | either one |
| Counter | <input type="radio"/> | <input type="radio"/> | |
| Keep relay | <input type="radio"/> | | either one |
| Data table | <input type="radio"/> | <input type="radio"/> | |

- <3> Alternatively, set the program protect signal (KEY4) to 1 only with the counter and data table.

- <4> Press a soft key and select a required screen.
 [TIMER] : Timer screen
 [COUNTR] : Counter screen
 [KEEPRL] : Keep relay screen
 [DATA] : Data table screen
- <5> Press cursor key and move the cursor to a desired number.
- <6> Input a numeric key and press INPUT key and data is input.
- <7> After input, return PWE or the KEY4 signal to the previous state.

**4.4.4.2
TIMER screen**

This screen is used for setting timer time of the Timer instruction (SUB 3).

Annotations:

- Page number (screen is scrolled by page key) points to "#001".
- Timer number specified with the Timer instruction points to "T000".
- Address referenced by the sequence program points to "T000".
- Set a timer period in ms. points to the DATA field of the first row.

| PMC PRM (TIMER) #001 | | | PMC RUN | | |
|----------------------|---------|------|---------|---------|------|
| NO. | ADDRESS | DATA | NO. | ADDRESS | DATA |
| 001 | T000 | 0 | 011 | T020 | 0 |
| 002 | T002 | 0 | 012 | T022 | 0 |
| 003 | T004 | 0 | 013 | T024 | 0 |
| 004 | T006 | 0 | 014 | T026 | 0 |
| 005 | T008 | 0 | 015 | T028 | 0 |
| 006 | T010 | 0 | 016 | T030 | 0 |
| 007 | T012 | 0 | 017 | T032 | 0 |
| 008 | T014 | 0 | 018 | T034 | 0 |
| 009 | T016 | 0 | 019 | T036 | 0 |
| 010 | T018 | 0 | 020 | T038 | 0 |

Soft keys: [TIMER] [COUNTR] [KEEPRL] [DATA] [SETING]

Timer set time : Timer No. 1-8 is max. 1572.8 sec and its accuracy is 48ms. Timer No. 9 to 250 is max. 262.1 sec and its accuracy is 8ms.

**4.4.4.3
COUNTER screen**

This screen sets and displays max. value of counter and current value of the counter instruction (SUB 5).

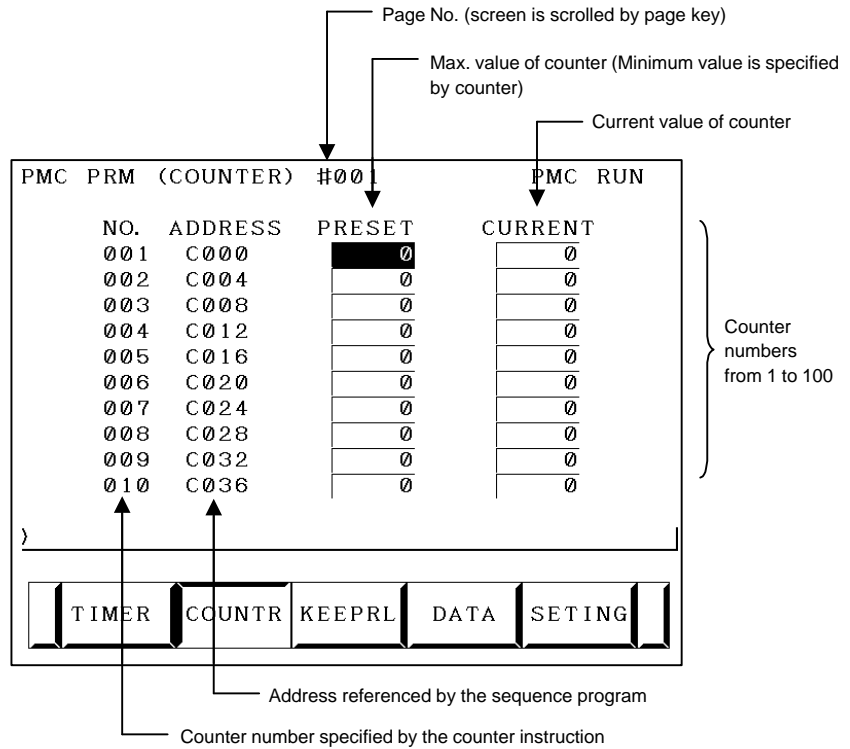

Counter formats and maximum values

| Counter format | Setting | Current value |
|----------------|---------|---------------|
| BINARY | 32767 | 32767 |
| BCD | 9999 | 9999 |

**4.4.4.4
KEEP RELAY screen**

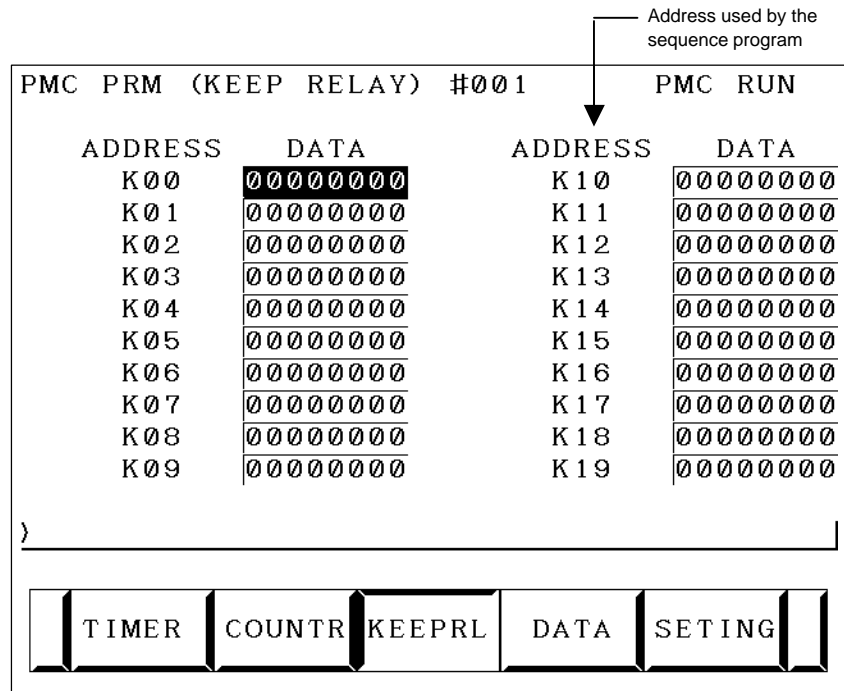

(i) Nonvolatile memory control

| | | | | | | | | |
|-----|--------|--------|----|----|----|----|----|----|
| | #7 | #6 | #5 | #4 | #3 | #2 | #1 | #0 |
| K16 | MWRTF2 | MWRTF1 | | | | | | |

#7 MWRTF2 This operation is performed for checking the writing status of the nonvolatile memory.

#6 MWRTF1 Writing status in nonvolatile memory

(ii)PMC system parameters

The keep relays below are used by the system, so that the keep relays cannot be used by the sequence program.

| | | | | | | | | |
|------|---------|----|----|--------|----|---------|---------|---------|
| | #7 | #6 | #5 | #4 | #3 | #2 | #1 | #0 |
| K900 | DTBLDSP | | | MEMINP | | AUTORUN | PROGRAM | LADMASK |

#0 LADMASK 0 : Access by the sequence program is enabled.

1 : Access by the sequence program is disabled.

#1 PROGRAM 0 : The built-in programmer function does not operate.
(Also, the programmer menu is not displayed.)

1 : The built-in programmer function operates.
(The programmer menu is displayed.)

#2 AUTORUN 0 : The sequence program automatically starts at power on.

1 : Pressing the soft key to sequence program execution starts the sequence program.

#4 MEMINP 0 : The forcing function and override function are disabled.

1 : The forcing function and override function are enabled.

- #7 DTBLDSP** 0 : The PMC parameter data table control screen is displayed.
1 : The PMC parameter data table control screen is not displayed.

| | #7 | #6 | #5 | #4 | #3 | #2 | #1 | #0 |
|------|---------|---------|---------|----------|---------|---------|---------|--------|
| K901 | IGNDINT | EDITLAD | CHKPRTY | CALCPRTY | TRNSRAM | TRGSTAT | DBGSTAT | IGNKEY |

- #0 IGNKEY** 0 : Function keys are enabled for a user program on the user screen.
1 : Function keys are disabled for a user program on the user screen.
* This flag is useful when a user program is used. When this bit is set to 1, the user screen cannot be switched to the NC screen by using the function keys. Program which invariably sets this bit to 0, or which switches the user screen to the NC screen, must be prepared.
- #1 DBGSTAT** 0 : The C language debug function does not start automatic break processing at power on.
1 : The C language debug function starts automatic break processing at power on.
* This flag is useful when a user program is used.
- #2 TRGSTAT** 0 : The trigger stop function does not automatically start at power on.
1 : The trigger stop function starts automatically at power on.
- #3 TRNSRAM** 0 : After on-line editing, the ladder program is not automatically transferred to the backup RAM.
1 : After on-line editing, the ladder program is automatically transferred to the backup RAM.
- #4 CALCPRTY** 0 : A RAM parity calculation is made with the built-in programmer function.
1 : No RAM parity calculation is made with the built-in programmer function.
- #5 CHKPRTY** 0 : The system ROM and program ROM/RAM are checked for parity errors.
1 : The system ROM and program ROM/RAM are not checked for parity errors.
- #6 EDITLAD** 0 : The editing of a sequence program is disabled.
1 : The editing of a sequence program is enabled.
- #7 IGNDINT** 0 : The system initializes the LCD when the screen is switched to the PMCMDI screen.
1 : The system does not initialize the LCD when the screen is switched to the PMCMDI screen.
* This flag is useful when a user program is used. When the screen is switched to the PMCMDI screen, PMC control software determines whether the system initialize the LCD, by checking this flag. When this flag is on, an application program must initialize the LCD.

| | | | | | | | | |
|------|---------|---------|----|----|----|--------|----------|----------|
| | #7 | #6 | #5 | #4 | #3 | #2 | #1 | #0 |
| K902 | PTCTPRM | HIDEPRM | | | | ALWSTP | C-REJECT | FROM-WRT |

- #0 FROM-WRT** 0 : After editing a ladder program, does not automatically write it to F-ROM.
1 : After editing a ladder program, automatically writes it to F-ROM.
- #1 C-REJECT** 0 : The system activates a C program.
1 : The system does not activate a C program.
- #2 ALWSTP** 0 : The execution/stop operation of a sequence program is disabled.
1 : The execution/stop operation of a sequence program is enabled.
- #6 HIDEPRM** 0 : The display of PMC parameters and the output of PMC parameters to the outside are enabled.
1 : The display of PMC parameters and the output of PMC parameters to the outside are disabled.
- #7 PTCTPRM** 0 : The modification and reading of PMC parameters are enabled.
1 : The modification and reading of PMC parameters are disabled.

| | | | | | | | | |
|------|----|----|---------|----|----|-------|----------|----------|
| | #7 | #6 | #5 | #4 | #3 | #2 | #1 | #0 |
| K906 | | | TRCSTAT | | | IOCHK | IOSELSCN | OVERRIDE |

- #0 OVERRIDE** 0 : Disables the override function.
1 : Enables the override function.
- #1 IOSELSCN** 0 : Does not display the I/O assignment selection function setting screen.
1 : Displays the I/O assignment selection function setting screen.
- #2 IOCHK** 0 : Enables the I/O Link connection check function. (Initial value).
1 : Disables the I/O Link connection check function.
- #5 TRCSTAT** 0 : Starts trace operation with the trace function when the execution soft key is pressed.
1 : Starts trace operation with the trace function automatically after the power is turned on.



CAUTION

Be sure to set any unused areas to 0.

4.4.4.5
Data table screen

(1) Data group setting screen

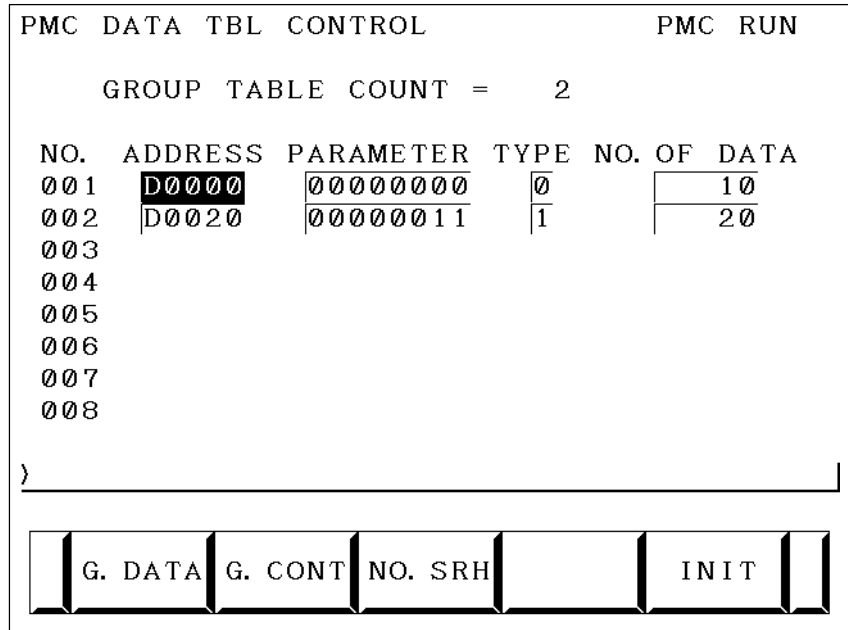

a) Display information

- GROUP TABLE COUNT : Number of data table groups
- NO. : Group number
- ADDRESS : Data table start address
- PARAMETER : Table parameter

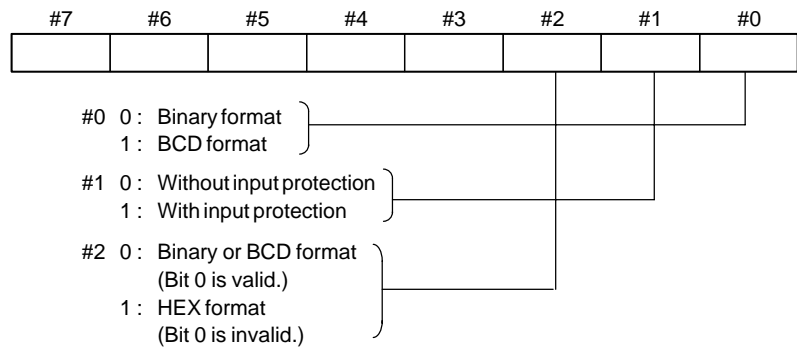

- TYPE : Data length (0: 1byte long, 1: 2bytes long, 2: 4bytes long)
- NO. OF DATA : Number of data items of each data table

b) Soft key

- [G.DATA] :
Switches the screen display to the data table screen.
- Number of groups + [G.CONT] :
Sets the number of data table groups.
- Group number + [NO.SRH] :
Moves the cursor to a specified group.
- [INIT] :
Initializes the setting of the data table.

(2) Data table screen

| PMC PRM (DATA) 001/001 | | BIN | PMC RUN |
|------------------------|---------|------------|---------|
| NO. | ADDRESS | | DATA |
| 0000 | D0000 | | 0 |
| 0001 | D0001 | | 0 |
| 0002 | D0002 | | 0 |
| 0003 | D0003 | | 0 |
| 0004 | D0004 | | 0 |
| 0005 | D0005 | | 0 |
| 0006 | D0006 | | 0 |
| 0007 | D0007 | | 0 |
| 0008 | D0008 | | 0 |
| 0009 | D0009 | | 0 |

| | | | | | |
|-----------|----------|----------|--|--|--|
| [C. DATA] | [G-SRCH] | [SEARCH] | | | |
|-----------|----------|----------|--|--|--|

- [C.DATA] :
Returns the screen display to the data group setting screen.
- Group number + [G-SRCH]:
Moves the cursor to the start of a specified group.
- Address + [SEARCH] :
Searches the currently selected group for a specified address.

4.4.4.6
Setting screens

(1) Setting screen for general functions

| PMC PRM (SETTING) | PMC RUN | | | | | | |
|--|--|----------|--------|------|--|------|------|
| TRACE START | = <input type="checkbox"/> (0:MANUAL 1:AUTO) | (K906.5) | | | | | |
| EDIT ENABLE | = <input type="checkbox"/> (0:NO 1:YES) | (K901.6) | | | | | |
| WRITE TO F-ROM(EDIT) | = <input type="checkbox"/> (0:NO 1:YES) | (K902.0) | | | | | |
| RAM WRITE ENABLE | = <input type="checkbox"/> (0:NO 1:YES) | (K900.4) | | | | | |
| DATA TBL CNTL SCREEN | = <input type="checkbox"/> (0:YES 1:NO) | (K900.7) | | | | | |
| HIDE PMC PARAM | = <input type="checkbox"/> (0:NO 1:YES) | (K902.6) | | | | | |
| PROTECT PMC PARAM | = <input type="checkbox"/> (0:NO 1:YES) | (K902.7) | | | | | |
| HIDE PMC PROGRAM | = <input type="checkbox"/> (0:NO 1:YES) | (K900.0) | | | | | |
| IO GROUP SELECTION | = <input type="checkbox"/> (0:HIDE 1:SHOW) | (K906.1) | | | | | |
| LADDER START | = <input type="checkbox"/> (0:AUTO 1:MANUAL) | (K900.2) | | | | | |
| } | | | | | | | |
| <table border="1" style="width: 100%; border-collapse: collapse;"> <tr> <td style="width: 20%; text-align: center; padding: 5px;">MANUAL</td> <td style="width: 20%; text-align: center; padding: 5px;">AUTO</td> <td style="width: 20%;"></td> <td style="width: 20%; text-align: center; padding: 5px;">PREV</td> <td style="width: 20%; text-align: center; padding: 5px;">NEXT</td> </tr> </table> | | | MANUAL | AUTO | | PREV | NEXT |
| MANUAL | AUTO | | PREV | NEXT | | | |

| PMC PRM (SETTING) | PMC RUN | | | | | | |
|---|---|----------|----|-----|--|--|--|
| ALLOW PMC STOP | = <input type="checkbox"/> (0:NO 1:YES) | (K902.2) | | | | | |
| PROGRAMMER ENABLE | = <input type="checkbox"/> (0:NO 1:YES) | (K900.1) | | | | | |
| } | | | | | | | |
| <table border="1" style="width: 100%; border-collapse: collapse;"> <tr> <td style="width: 20%; text-align: center; padding: 5px;">NO</td> <td style="width: 20%; text-align: center; padding: 5px;">YES</td> <td style="width: 20%;"></td> <td style="width: 20%;"></td> <td style="width: 20%;"></td> </tr> </table> | | | NO | YES | | | |
| NO | YES | | | | | | |

NOTE
The parenthesized values to the right of the screen indicate keep relay addresses.

(2) Message function screen for each language

| | | | | | | | |
|---|---|--|------|------|------|--|--|
| PMC PRM (MESSAGE SHIFT) | PMC RUN | | | | | | |
| MESSAGE SHIFT VALUE | = <input style="width: 50px;" type="text" value="0"/> | | | | | | |
| MESSAGE SHIFT START ADDRESS | = <input style="width: 50px;" type="text" value="A0000.0"/> | | | | | | |
| } | | | | | | | |
| <table border="1" style="width: 100%; border-collapse: collapse;"> <tr> <td style="width: 15%; text-align: center;">INPUT</td> <td style="width: 15%;"></td> <td style="width: 15%;"></td> <td style="width: 15%; text-align: center;">PREV</td> <td style="width: 15%; text-align: center;">NEXT</td> <td style="width: 15%;"></td> </tr> </table> | INPUT | | | PREV | NEXT | | |
| INPUT | | | PREV | NEXT | | | |

Display information

- MESSAGE SHIFT VALUE :
Enter a shift amount for a message display request. A value from 0 to 1999 can be specified. Even when the power is turned off, entered data is preserved.
- MESSAGE SHIFT START ADDRESS :
Enter the start bit address of a shifted message display request bit area. An address in the A address area can be specified. Even when the power is turned off, entered data is preserved.

(3) Override mode screen of the forced input/output function

| | | | | | | | |
|---|--|-----|------|------|------|--|--|
| PMC PRM (OVERRIDE) | PMC RUN | | | | | | |
| OVERRIDE ENABLE | = <input style="width: 20px;" type="checkbox"/> (0 : NO 1 : YES) (K906.0) | | | | | | |
| } | | | | | | | |
| <table border="1" style="width: 100%; border-collapse: collapse;"> <tr> <td style="width: 15%; text-align: center;">NO</td> <td style="width: 15%; text-align: center;">YES</td> <td style="width: 15%;"></td> <td style="width: 15%; text-align: center;">PREV</td> <td style="width: 15%; text-align: center;">NEXT</td> <td style="width: 15%;"></td> </tr> </table> | NO | YES | | PREV | NEXT | | |
| NO | YES | | PREV | NEXT | | | |

Display information

- OVERRIDE ENABLE
0: Disables overriding.
1: Enables overriding.

(4) I/O Link assignment data selection function setting screen

| PMC PRM (SELECT I/O) | PMC RUN | | | | | | |
|---|---------------------------|--------------------|------|------|--|------|------|
| SELECTABLE I/O LINK ASSIGNMENT FUNCTION | | | | | | | |
| EFFECTIVE GROUP SELECTION (0:NO 1:YES) | | | | | | | |
| GROUP NO. (CH1) | : 00 01 02 03 04 05 06 07 | (K910.0 to K910.7) | | | | | |
| | : * * * 1 0 1 0 0 | | | | | | |
| | : 08 09 10 11 12 13 14 15 | (K911.0 to K911.7) | | | | | |
| | : 0 0 1 0 0 0 0 0 | | | | | | |
| GROUP NO. (CH2) | : 00 01 02 03 04 05 06 07 | (K912.0 to K912.7) | | | | | |
| | : * * 0 0 1 1 0 0 | | | | | | |
| | : 08 09 10 11 12 13 14 15 | (K913.0 to K913.7) | | | | | |
| | : 0 0 0 0 0 0 1 0 | | | | | | |
| } | | | | | | | |
| <table border="1" style="width: 100%; border-collapse: collapse;"> <tr> <td style="width: 20%; text-align: center;">NO</td> <td style="width: 20%; text-align: center;">YES</td> <td style="width: 20%;"></td> <td style="width: 20%; text-align: center;">PREV</td> <td style="width: 20%; text-align: center;">NEXT</td> </tr> </table> | | | NO | YES | | PREV | NEXT |
| NO | YES | | PREV | NEXT | | | |

In this setting parameter, set the group of an I/O device connected to each machine.

EFFECTIVE GROUP SELECTION (CH1: K910 to K911):
 Select a group in which I/O Link assignment data is valid.

0: Disables assignment.

1: Enables assignment.

The basic group section set in “BASIC GROUP COUNT” on the system parameter screen is marked with *, and disables this setting.

NOTE

Channel 2 can not be used.

4.4.5 PMC Data Input/Output

4.4.5.1 Starting the built-in programmer

NOTE

When data is input through the MDI keys, the operations below need not be performed:

- (1) Select the PMC screen. Press the [SYSTEM] soft key, then press the [PMC] soft key.
- (2) When the built-in programmer is started, the items below are displayed. When the items of RUN/STOP, EDIT, I/O, SYSPRM, and MONIT are displayed, the built-in programmer is already started.

| PMC CONTROL SYSTEM MENU | PMC RUN |
|-----------------------------------|-----------------------------|
| SELECT ONE OF FOLLOWING SOFT KEYS | |
| PMCLAD | : LADDER DIAGRAM |
| PMCDGN | : DIAGNOSIS FUNCTION |
| PMCPRM | : PARAMETER (T/C/K/D) |
| RUN/STOP | : RUN/STOP SEQUENCE PROGRAM |
| EDIT | : EDIT FUNCTION |
| I/O | : I/O SEQUENCE PROGRAM |
| SYSPRM | : SYSTEM PARAMETER |
| MONIT | : PMC MONITOR |

| | | | | |
|------|------|-----|--------|-------|
| STOP | EDIT | I/O | SYSPRM | MONIT |
|------|------|-----|--------|-------|

- (3) When the built-in programmer is not started, set the keep relay K900.1 to 1.

4.4.5.2

Input/output method

- (1) Press the [I/O] soft key.
- (2) The screen shown below appears.

| PMC I/O PROGRAM | PMC RUN | | | | | |
|--|---------|--------|--------|--------|-------|-------|
| CHANNEL = | 1 | | | | | |
| DEVICE = | FDCAS | | | | | |
| FUNCTION = | WRITE | | | | | |
| DATA KIND = | LADDER | | | | | |
| FILE NO. = | -1 | | | | | |
| (-1:ADD, 0:INIT, @NAME) | | | | | | |
| } | | | | | | |
| <table border="1" style="width: 100%; border-collapse: collapse; margin-top: 10px;"> <tr> <td style="padding: 5px;">EXEC</td> <td style="padding: 5px;">CANCEL</td> <td style="padding: 5px;">M-CARD</td> <td style="padding: 5px;">F-ROM</td> <td style="padding: 5px;">FDCAS</td> </tr> </table> | | EXEC | CANCEL | M-CARD | F-ROM | FDCAS |
| EXEC | CANCEL | M-CARD | F-ROM | FDCAS | | |

- (3) Select an I/O device in "DEVICE".
 - [FDCAS] : Input to, and output from, a floppy cassette adapter
 - [F-ROM] : Input to, and output from, a flash EEPROM
 - [M-CARD] : Input to, and output from, a memory card
 - [OTHERS] : Input to, and output from, other I/O devices
- (4) Set a channel number in "CHANNEL".
 - When [F-ROM] or [OTHERS] is selected in "DEVICE", set this item.
 - Enter a channel number, then press the INPUT key or [(NO.)].
 - Main CPU board JD5A=1
JD5B=2
- (5) Select a function in "FUNCTION".
 - [WRITE] : Outputs data.
 - [READ] : Inputs data.
 - [COMPAR] : Compares the data in an external device with the data in memory.
 - [DELETE] : Deletes the files from the floppy disk or memory card.
 - [LIST] : Displays the directory of files in the floppy disk or memory card.
 - [FORMAT] : Initializes the memory card. (All data in the memory card is erased.)
- (6) Select a type of output data in "DATA KIND".
 - [LADDER] : Ladder
 - [PARAM] : PMC parameter
- (7) When [FDCAS] or [M-CARD] is selected, a file can be specified in "FILE NO.". A file can be specified by file number or by file name. When specifying a file name, prefix @ or # to the file name.
- (8) Select an RS-232C setting condition. [SPEED]
 - For each "DEVICE", set a condition.

(9) Check that the settings above are correct, then press the [EXEC] soft key.

**4.4.6
System Parameters**

(1) System parameter screen (1/3)

| | | |
|----------------------------|-----|----------------------|
| PMC SYSTEM PARAMETER (1/3) | | PMC STOP |
| COUNTER DATA TYPE | = | BINARY / BCD |
| LADDER EXEC | = | <u>150</u> % (1-150) |
| } | | |
| | | |
| BINARY | BCD | |
| | | |

Display information

- COUNTER DATA TYPE :
Specify the binary format or BCD format for a counter value to be used with the function instruction CTR.
- LADDER EXEC :
Set a processing time for the first and second ladder levels (1% to 150%). This setting increases or decreases ladder scan time.

(2) System parameter screen (2/3)

| | | |
|----------------------------|----|-----------------|
| PMC SYSTEM PARAMETER (2/3) | | PMC STOP |
| FS0 OPERATOR PANEL | = | YES / NO |
| KEY DI ADDRESS | = | <u>X0100</u> |
| LED DO ADDRESS | = | <u>Y0100</u> |
| KEY BIT IMAGE ADDRESS | = | <u>R0900</u> |
| LED BIT IMAGE ADDRESS | = | <u>R0910</u> |
| } | | |
| | | |
| YES | NO | |
| | | |

Display information

- **FS0 OPERATOR PANEL :**
Set whether to connect an operator’s panel for the FS0.
- **KEY DI ADDRESS :**
Set the start address of an external DI actually connected.
- **LED DO ADDRESS :**
Set the start address of an external DO actually connected.
- **KEY BIT IMAGE ADDRESS :**
Set the start address of a key image referenced by a user program. Usually, set an arbitrary internal relay (R) area.
- **LED BIT IMAGE ADDRESS :**
Set the start address of an LED image generated by a user program. Usually, set an arbitrary internal relay (R) area.

(3) System parameter screen (3/3)

On this screen, make settings related to the I/O Link assignment selection function.

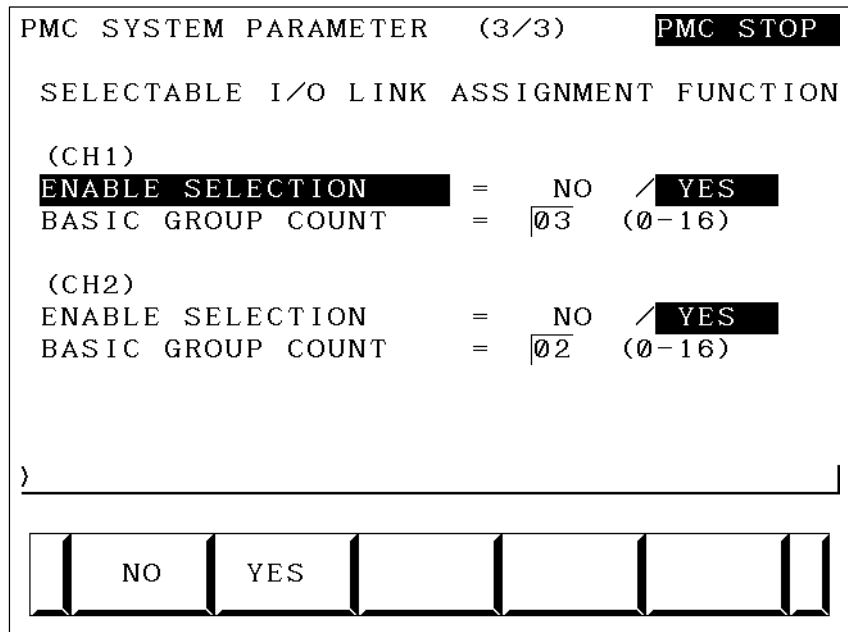

Display information

- **ENABLE SELECTION**
[NO] : Does not use the I/O Link assignment data selection function.
[YES] : Uses the I/O Link assignment data selection function.
When [NO] is specified for both of channel 1 and channel 2, the I/O Link assignment data selection function setting screen described in item (4) of Subsection 4.4.4.6, “Setting screens” is not displayed.
- **BASIC GROUP COUNT :**
This parameter divides the I/O Link assignment data into the basic group section and the parameter selection group section. Set the number of groups in the basic group section. Enter a value from 0 to 16, then press the [INPUT] soft key.

Example

3 : BASIC GROUP COUNT 0 to 2 groups
 Parameter selection group section 3 to 15 groups

4.4.7 Online Monitor Setting Screen

```

PARAMETERS FOR ONLINE MONITOR   PMC RUN
CPU ID      = ██████████
RS-232C    = USE /NOT USE
CHANNEL    = 1
BAUD RATE  = 300/600/1200/2400/4800/
           9600/19200
PARITY     = NONE/ODD /EVEN
STOP BIT   = 1 BIT/2 BITS
RS-232C    = INACTIVE           : 0
HIGH SPEED I/F = STAND-BY      : 0
}

```

| | | | | |
|--|--|--|--------|------|
| | | | EMG ST | INIT |
|--|--|--|--------|------|

(a) Soft key

- [EMG ST] : Terminates communication forcibly. Use this key if communication becomes abnormal and the connection cannot be terminated normally.
- [INIT] : Initializes the parameters to their default values.

(b) Setting

- CPU ID : Displays a CPU ID value. However, do not modify this item.
- RS-232C : Enables communication setting in the case of connection via RS-232C. However, do not modify the items of timer 1, timer 2, timer 3, and maximum packet size.
- HIGH SPEED I/F : Enables setting for connection via a high-speed interface (HSSB, Ethernet).

(c) Communication status

- USE TIME : The maximum time in the communication processing is displayed.
- RS-232C : The communication condition of RS-232C is displayed.
- HIGH SPEED I/F : The communication condition of HIGH SPEED I/F is displayed.
- ETHER_BOARD : Displayed during the communication with Ethernet board. The IP address of the communication partner is displayed.

- **EMB_ETHERNET**: Displayed during the communication with embedded Ethernet. The IP address of the communication partner is displayed.
- **HSSB** : Displayed during the communication with HSSB.

Display messages and the meanings

| Display messages | Meanings |
|-------------------------|--|
| INACTIVE | The communication is inactive. |
| STOPPING | The communication is being stopped. (Wait for the termination of communication) |
| STARTING | The communication is being started. (Wait for the termination of communication over another communication path) |
| STAND-BY | The communication is active and in standby mode. |
| CONNECTED | The communication is active and being connected. |
| NO OPTION | The port can be not opened because there is not option of RS-232C. |
| BAD PARAMETER | Invalid open parameters are specified. |
| TIMEOUT ERROR | A time-out has occurred and communication is aborted. |
| TIMEOUT(K) ERROR | A time-out has occurred and communication is aborted. |
| BCC ERROR | A Block Check Code (packet parity) error has occurred. |
| PARITY ERROR | A parity error has occurred. |
| OVER-RUN ERROR | A reception overrun has occurred and the communication can not recover. |
| SEQUENCE ERROR | Packets are out of sequence. (Incorrect procedure) |
| DATA ERROR | Incorrect packets have been received through retry process. |
| QUEUE OVERFLOW | The transmit/receive queue has overflowed. |
| DISCONNECTED | Communication has been terminated successfully. |
| NO CONNECTION | The cable is disconnected. |

4.5 LIST OF SIGNALS BY EACH MODE



CAUTION

The signal list also contains a description of the signals for the functions that are invalid for the Series 0i-C and Series 0i Mate-C.

• Automatic operation

| MODE | | INPUT/OUTPUT SIGNAL | FEED RATE, ETC |
|---------------------|-------------------|---|---|
| AUTOMATIC OPERATION | EDIT | [PMC ⇒ CNC] KEY3(Program protect key) | |
| | MEM MDI RMT | [PMC ⇒ CNC] ST (Cycle start) *SP (Feed hold) SBK (Single block) DRN (Dry run) BDT1 to 9 (Block delete) MIα (Mirror image) STLK (Start lock: T series) CDZ (Chamfering: T series) SMZ (In-position check: T series) PN1 to 8 (External program no. search) MINP (External program input) DNCI (DNC input mode) DMMC (C direct operation) HSα1A to D (Handle interrupt axis select) AFL (Auxiliary function neglect) FIN, MFIN2, MFIN3 (Auxiliary function complete) MFIN, SFIN, TFIN, BFIN (High speed M/S/T function complete) | [PMC ⇒ CNC] *FV0 to 7 (Feed rate override) *AFV0 to 7 (2nd feed rate override) OVC (Override cancel) ROV1,ROV2, HROV, *HROV0 to 6 (Rapid traverse override) SOV0 to 7 (Spindle speed override) |
| | | [CNC ⇒ PMC] STL (Cycle start LED) SPL (Feed hold LED) MF, M00 to M31 } (Auxiliary function) MF2, M200 to M215 } MF3, M300 to M315 } SF, S00 to S31 (Spindle speed function) TF, T00 to T31 (Tool function) BF, B00 to B31 (2nd miscellaneous func.) DEN (Distribution end) OP (automatic operating) GR10 to GR30(Gear selection: M series) | |

- Manual operation

| MODE | | INPUT/OUTPUT SIGNAL | FEED RATE, ETC |
|---|------------------------|---|---|
| M A N U A L O P E R A T I O N | Handle/ incremental | [PMC ⇒ CNC] HSnA to D (Axis selection) n:1 to 3(No. of MPGs) +α, -α (Jog feed) | [PMC ⇒ CNC] MP1, MP2 (Multiplier) |
| | JOG | [PMC ⇒ CNC] RT (Rapid traverse) | [PMC ⇒ CNC] *JV0 to 15 (Manual feed-rate override) |
| | Z R N | [PMC ⇒ CNC] ZRN(Reference position return mode) [MT ⇒ CNC] *DECα (Reference position deceleration) [CNC ⇒ PMC] ZPα ZP2α, ZP3α, ZP4α (Reference position return completion) | +α, -α (Manual feed move command) ROV1, ROV2 HROV *HROV0 to 6 (Rapid traverse override) |

- Others

| | |
|--------|--|
| Others | [PMC ⇒ CNC] MD1 to 4 (Mode selection) *ESP (Emergency stop) KEY1 to 4 (Memory protection key) MLK,MLKα (All axes/ each axis machine lock) *IT,*ITα (All axes/ each axis machine lock) *±MITα (interlock per axis and direction:M series) STLK (Start lock:T series) *ABSM (Manual absolute) SVFα (Servo off) *FLWP (Follow up) ERS (External reset) RRW (Reset & Rewind) EXLM (Stored stroke limit external switching) ±LMα, RLSOT (Software limit external setting M series) *±Lα (Overtravel limit) *±EDα (External deceleration of each axis) |
| | [CMC ⇒ PMC] MA (NC ready) SA (Servo ready) AL (NC alarm) RST (Resetting) BAL (Battery alarm) INPα (In-position) MVα (Axis moving) TAP (Tapping) |

4.6 LIST OF INPUT/ OUTPUT SIGNALS

The relationship of the addresses of the interface signals transferred between the CNC and PMC are shown below.

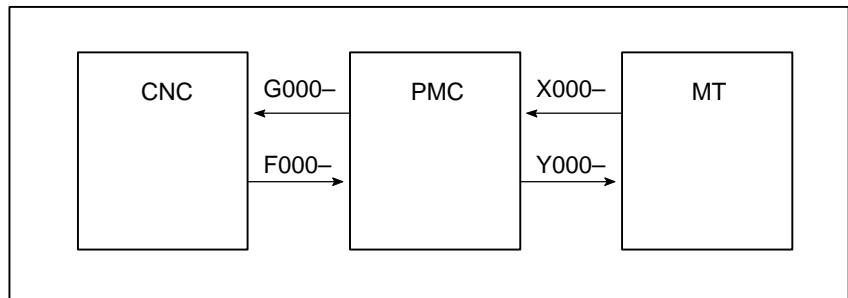

● **List of input/output signals**

○ : Available
 - : Unavailable

| Symbol | Signal name | Address | T series | M series |
|------------------|--|------------------|----------|----------|
| *+ED1 to *+ED4 | External deceleration signal | G118 | ○ | ○ |
| *+L1 to *+L4 | Overtravel signal | G114 | ○ | ○ |
| *-ED1 to *-ED4 | External deceleration signal | G120 | ○ | ○ |
| *-L1 to *-L4 | Overtravel signal | G116 | ○ | ○ |
| *ABSM | Manual absolute signal | G006#2 | ○ | ○ |
| *BECLP | B-axis clamp completion signal | G038#7 | - | ○ |
| *BEUCP | B-axis unclamp completion signal | G038#6 | - | ○ |
| *BSL | Block start interlock signal | G008#3 | ○ | ○ |
| *CRTOF | Automatic erase CRT screen display cancel signal | G062#1 | ○ | ○ |
| *CSL | Cutting block start interlock signal | G008#1 | ○ | ○ |
| *DEC1 to *DEC4 | Deceleration signal for reference position return | X009 | ○ | ○ |
| *EAXSL | Control axis selection status signal(PMC axis control) | F129#7 | ○ | ○ |
| *ESP | Emergency stop signal | X008#4 | ○ | ○ |
| *ESP | | G008#4 | ○ | ○ |
| *ESPA | Emergency stop signal (serial spindle) | G071#1 | ○ | ○ |
| *ESPB | | G075#1 | ○ | ○ |
| *FLWU | Follow-up signal | G007#5 | ○ | ○ |
| *FV0 to *FV7 | Feedrate override signal | G012 | ○ | ○ |
| *FV0E to *FV7E | Feedrate override signal (PMC axis control) | G151 | ○ | ○ |
| *FV0O to *FV7O | Software operator's panel signal(*FV0 to *FV7) | F078 | ○ | ○ |
| *HROV0 to *HROV6 | 1% step rapid traverse override signal | G096#0 to #6 | ○ | ○ |
| *IT | Interlock signal | G008#0 | ○ | ○ |
| *IT1 to *IT4 | Interlock signal for each axis | G130 | ○ | ○ |
| *JV0 to *JV15 | Manual feedrate override signal | G010,G011 | ○ | ○ |
| *JV0O to *JV15O | Software operator's panel signal(*JV0 to *JV15) | F079,F080 | ○ | ○ |
| *PLSST | Polygon spindle stop signal | G038#0 | ○ | - |
| *SCPF | Spindle clamp completion signal | G028#5 | ○ | - |
| *SP | Feed hold signal | G008#5 | ○ | ○ |
| *SSTP | Spindle stop signal | G029#6 | ○ | ○ |
| *SSTP1 | Individual spindle stop signals | G027#3 | ○ | ○ |
| *SSTP2 | | G027#4 | ○ | ○ |
| *SSTP3 | | G027#5 | ○ | ○ |
| *SUCPF | Spindle unclamp completion signal | G028#4 | ○ | - |
| *TLV0 to *TLV9 | Tool life count override signal | G049#0 to G050#1 | - | ○ |
| *TSB | Tailstock barrier select signal | G060#7 | ○ | - |
| +EXL1 to +EXL4 | Axis direction dependent stored stroke limit switch signal | G104 | ○ | ○ |
| +J1 to +J4 | Feed axis and direction selection signal | G100 | ○ | ○ |

| Symbol | Signal name | Address | T series | M series |
|-------------------|--|-----------------|----------|----------|
| +J1O to +J4O | Software operator's panel signal(+J1 to +J4) | F081#0,#2,#4,#6 | ○ | ○ |
| +LM1 to +LM4 | Stroke limit external setting signal | G110 | — | ○ |
| +MIT1,+MIT2 | Manual feed interlock signal for each axis | X004#2,#4 | ○ | — |
| +MIT1,+MIT2 | Tool offset write signal | X004#2,#4 | ○ | — |
| +MIT1 to +MIT4 | Interlock signal for each axis and direction | G132#0 to #3 | — | ○ |
| +OT1 to +OT4 | Stroke limit reached signals | F124 | — | ○ |
| —EXL1 to —EXL4 | Axis direction dependent stored stroke limit switch signal | G105 | ○ | ○ |
| —J1 to —J4 | Feed axis and direction selection signal | G102 | ○ | ○ |
| —J1O to —J4O | Software operator's panel signal(—J1 to —J4) | F081#1,#3,#5,#7 | ○ | ○ |
| —LM1 to —LM4 | Stroke limit external setting signal | G112 | — | ○ |
| —MIT1,—MIT2 | Manual feed interlock signal for each axis | X004#3,#5 | ○ | — |
| —MIT1,—MIT2 | Tool offset write signal | X004#3,#5 | ○ | — |
| —MIT1 to —MIT4 | Interlock signal for each axis and direction | G134#0 to #3 | — | ○ |
| —OT1 to —OT4 | Stroke limit reached signals | F126 | — | ○ |
| ABTQSV | Servo axis abnormal load detected signal | F090#0 | ○ | ○ |
| ABTSP1 | First—spindle abnormal load detected signal | F090#1 | ○ | ○ |
| ABTSP2 | Second—spindle abnormal load detected signal | F090#2 | ○ | ○ |
| AFL | Miscellaneous function lock signal | G005#6 | ○ | ○ |
| AICC | AI advanced control mode signal | F062#0 | — | ○ |
| AL | Alarm signal | F001#0 | ○ | ○ |
| ALMA | Alarm signal (serial spindle) | F045#0 | ○ | ○ |
| ALMB | | F049#0 | ○ | ○ |
| AR0 to AR15 | Actual spindle speed signal | F040,F041 | ○ | — |
| ARSTA | Alarm reset signal (serial spindle) | G071#0 | ○ | ○ |
| ARSTB | | G075#0 | ○ | ○ |
| B00 to B31 | 2nd auxiliary function code signal | F030 to F033 | ○ | ○ |
| BAL | Battery alarm signal | F001#2 | ○ | ○ |
| BCLP | B—axis clamp signal | F061#1 | — | ○ |
| BDT1,BDT2 to BDT9 | Optional block skip signal | G044#0,G045 | ○ | ○ |
| BDTO | Software operator's panel signal(BDT) | F075#2 | ○ | ○ |
| BF | 2nd auxiliary function strobe signal | F007#4 | ○ | — |
| BF | | F007#7 | — | ○ |
| BFIN | 2nd auxiliary function completion signal | G005#4 | ○ | — |
| BFIN | | G005#7 | — | ○ |
| BGEACT | Background busy signal | F053#4 | ○ | ○ |
| BGEN | Power Mate background busy signal | G092#4 | ○ | ○ |
| BGIALM | Power Mate read/write alarm signal | G092#3 | ○ | ○ |
| BGION | Power Mate read/write inprogress signal | G092#2 | ○ | ○ |
| BUCLP | B—axis unclamp signal | F061#0 | — | ○ |
| CDZ | Chamferring signal | G053#7 | ○ | — |

| Symbol | Signal name | Address | T series | M series |
|------------------|---|--------------|----------|----------|
| CFINA | Spindle switch completion signal (serial spindle) | F046#1 | ○ | ○ |
| CFINB | | F050#1 | ○ | ○ |
| CHPA | Power line switch signal (serial spindle) | F046#0 | ○ | ○ |
| CHPB | | F050#0 | ○ | ○ |
| CLRCH1 to CLRCH4 | Torque limit reach signals for butt-type reference position setting | F180 | ○ | ○ |
| CON | Cs contour control change signal | G027#7 | ○ | ○ |
| CSS | Constant surface speed signal | F002#2 | ○ | ○ |
| CTH1A,CTH2A | Clutch/gear signal (serial spindle) | G070#3,#2 | ○ | ○ |
| CTH1B,CTH2B | | G074#3,#2 | ○ | ○ |
| CUT | Cutting feed signal | F002#6 | ○ | ○ |
| DEFMDA | Differential mode command signal (serial spindle) | G072#3 | ○ | ○ |
| DEFMDB | | G076#3 | ○ | ○ |
| DEN | Distribution end signal | F001#3 | ○ | ○ |
| DM00 | Decode M signal | F009#7 | ○ | ○ |
| DM01 | | F009#6 | ○ | ○ |
| DM02 | | F009#5 | ○ | ○ |
| DM30 | | F009#4 | ○ | ○ |
| DMMC | Direct operation select signal | G042#7 | ○ | ○ |
| DNCI | DNC operation select signal | G043#5 | ○ | ○ |
| DRN | Dry run signal | G046#7 | ○ | ○ |
| DRNE | Dry run signal (PMC axis control) | G150#7 | ○ | ○ |
| DRNO | Software operator's panel signal(DRN) | F075#5 | ○ | ○ |
| DSCNA | Disconnection detection disbalance signal (serial spindle) | G073#4 | ○ | ○ |
| DSCNB | | G077#4 | ○ | ○ |
| DSP1, DSP2 | Spindle motor speed detection signals | Y(n+1)#0, #1 | ○ | ○ |
| DSV1 to DSV4 | Servo motor speed detection signals | Y(n+0) | ○ | ○ |
| EA0 to EA6 | Address signal for external data input | G002#0 to #6 | ○ | ○ |
| EABUFA | Buffer full signal (PMC axis control) | F131#1 | ○ | ○ |
| EABUFB | | F134#1 | ○ | ○ |
| EABUFC | | F137#1 | ○ | ○ |
| EABUFD | | F140#1 | ○ | ○ |
| EACNT1 to EACNT4 | Controlling signal (PMC axis control) | F182 | ○ | ○ |
| EADEN1 to EADEN4 | Distribution completion signal(PMC axis control) | F112 | ○ | ○ |
| EAX1 to EAX4 | Control axis select signal (PMC axis control) | G136 | ○ | ○ |
| EASIP1 to EASIP4 | Axis control superimposed command signal | G200 | ○ | ○ |
| EBSYA | Axis control command read completion signal (PMC axis control) | F130#7 | ○ | ○ |
| EBSYB | | F133#7 | ○ | ○ |
| EBSYC | | F136#7 | ○ | ○ |
| EBSYD | | F139#7 | ○ | ○ |

| Symbol | Signal name | Address | T series | M series |
|--------------|---|--------------|----------|----------|
| EBUFA | Axis control command read signal(PMC axis control) | G142#7 | ○ | ○ |
| EBUFB | | G154#7 | ○ | ○ |
| EBUFC | | G166#7 | ○ | ○ |
| EBUFD | | G178#7 | ○ | ○ |
| EC0A to EC6A | Axis control command signal (PMC axis control) | G143#0 to #6 | ○ | ○ |
| EC0B to EC6B | | G155#0 to #6 | ○ | ○ |
| EC0C to EC6C | | G167#0 to #6 | ○ | ○ |
| EC0D to EC6D | | G179#0 to #6 | ○ | ○ |
| ECKZA | Following zero checking signal (PMC axis control) | F130#1 | ○ | ○ |
| ECKZB | | F133#1 | ○ | ○ |
| ECKZC | | F136#1 | ○ | ○ |
| ECKZD | | F139#1 | ○ | ○ |
| ECLRA | Reset signal (PMC axis control) | G142#6 | ○ | ○ |
| ECLRB | | G154#6 | ○ | ○ |
| ECLRC | | G166#6 | ○ | ○ |
| ECLRD | | G178#6 | ○ | ○ |
| ED0 to ED15 | Data signal for external data input | G000,G001 | ○ | ○ |
| EDENA | Auxiliary function executing signal (PMC axis control) | F130#3 | ○ | ○ |
| EDENB | | F133#3 | ○ | ○ |
| EDENC | | F136#3 | ○ | ○ |
| EDEND | | F139#3 | ○ | ○ |
| EDGN | Slave diagnosis selection signal | F177#7 | ○ | ○ |
| EF | External operation signal | F008#0 | - | ○ |
| EFD | External operation signal for high-speed interface | F007#1 | - | ○ |
| EFIN | External operation function completion signal | G005#1 | - | ○ |
| EFINA | Auxiliary function completion signal (PMC axis control) | G142#0 | ○ | ○ |
| EFINB | | G154#0 | ○ | ○ |
| EFINC | | G166#0 | ○ | ○ |
| EFIND | | G178#0 | ○ | ○ |
| EGENA | Axis moving signal (PMC axis control) | F130#4 | ○ | ○ |
| EGENB | | F133#4 | ○ | ○ |
| EGENC | | F136#4 | ○ | ○ |
| EGEND | | F139#4 | ○ | ○ |
| EIALA | Alarm signal (PMC axis control) | F130#2 | ○ | ○ |
| EIALB | | F133#2 | ○ | ○ |
| EIALC | | F136#2 | ○ | ○ |
| EIALD | | F139#2 | ○ | ○ |

| Symbol | Signal name | Address | T series | M series |
|-----------------|---|--------------|----------|----------|
| EID0A to EID31A | Axis control data signal (PMC axis control) | G146 to G149 | ○ | ○ |
| EID0B to EID31B | | G158 to G161 | ○ | ○ |
| EID0C to EID31C | | G170 to G173 | ○ | ○ |
| EID0D to EID31D | | G182 to G185 | ○ | ○ |
| EIF0A to EIF15A | Axis control feedrate signal (PMC axis control) | G144,G145 | ○ | ○ |
| EIF0B to EIF15B | | G156,G157 | ○ | ○ |
| EIF0C to EIF15C | | G168,G169 | ○ | ○ |
| EIF0D to EIF15D | | G180,G181 | ○ | ○ |
| EINPA | In-position signal (PMC axis control) | F130#0 | ○ | ○ |
| EINPB | | F133#0 | ○ | ○ |
| EINPC | | F136#0 | ○ | ○ |
| EINPD | | F139#0 | ○ | ○ |
| EKC0 to EKC7 | Key code signal | G098 | ○ | ○ |
| EKENB | Key code read completion signal | F053#7 | ○ | ○ |
| EKSET | key code read signal | G066#7 | ○ | ○ |
| ELCKZA | Accumulated zero check signal | G142#1 | ○ | ○ |
| ELCKZB | | G154#1 | ○ | ○ |
| ELCKZC | | G166#1 | ○ | ○ |
| ELCKZD | | G178#1 | ○ | ○ |
| EM11A to EM48A | Auxiliary function code signal (PMC axis control) | F132,F142 | ○ | ○ |
| EM11B to EM48B | | F135,F145 | ○ | ○ |
| EM11C to EM48C | | F138,F148 | ○ | ○ |
| EM11D to EM48D | | F141,F151 | ○ | ○ |
| EMBUFA | Buffering disable signal (PMC axis control) | G142#2 | ○ | ○ |
| EMBUFB | | G154#2 | ○ | ○ |
| EMBUFC | | G166#2 | ○ | ○ |
| EMBUFD | | G178#2 | ○ | ○ |
| EMFA | Auxiliary function strobe signal (PMC axis control) | F131#0 | ○ | ○ |
| EMFB | | F134#0 | ○ | ○ |
| EMFC | | F137#0 | ○ | ○ |
| EMFD | | F140#0 | ○ | ○ |
| EMSBKA | Block stop disable signal (PMC axis control) | G143#7 | ○ | ○ |
| EMSBKB | | G155#7 | ○ | ○ |
| EMSBKC | | G167#7 | ○ | ○ |
| EMSBKD | | G179#7 | ○ | ○ |
| ENB | Spindle enable signal | F001#4 | ○ | ○ |
| ENB2 | | F038#2 | ○ | - |
| ENB3 | | F038#3 | ○ | - |
| ENBKY | External key input mode selection signal | G066#1 | ○ | ○ |

| Symbol | Signal name | Address | T series | M series |
|---------------|---|------------------|----------|----------|
| EOTNA | Negative-direction overtravel signal (PMC axis control) | F130#6 | ○ | ○ |
| EOTNB | | F133#6 | ○ | ○ |
| EOTNC | | F136#6 | ○ | ○ |
| EOTND | | F139#6 | ○ | ○ |
| EOTPA | Positive-direction overtravel signal (PMC axis control) | F130#5 | ○ | ○ |
| EOTPB | | F133#5 | ○ | ○ |
| EOTPC | | F136#5 | ○ | ○ |
| EOTPD | | F139#5 | ○ | ○ |
| EOV0 | Override 0% signal (PMC axis control) | F129#5 | ○ | ○ |
| EPARM | Slave parameter selection signal | F177#6 | ○ | ○ |
| EPN0 to EPN13 | Expanded workpiece number search signals | G024#0 to G025#5 | ○ | ○ |
| EPNS | Expanded workpiece number search start signal | G025#7 | ○ | ○ |
| EPRG | Slave program selection signal | F177#4 | ○ | ○ |
| ERDIO | Slave external read start signal | F177#1 | ○ | ○ |
| EREND | Read completion signal for external data input | F060#0 | ○ | ○ |
| ERS | External reset signal | G008#7 | ○ | ○ |
| ESBKA | Block stop signal (PMC axis control) | G142#3 | ○ | ○ |
| ESBKB | | G154#3 | ○ | ○ |
| ESBKC | | G166#3 | ○ | ○ |
| ESBKD | | G178#3 | ○ | ○ |
| ESEND | Search completion signal for external data input | F060#1 | ○ | ○ |
| ESKIP | Skip signal (PMC axis control) | X004#6 | ○ | ○ |
| ESOFA | Servo off signal (PMC axis control) | G142#4 | ○ | ○ |
| ESOFB | | G154#4 | ○ | ○ |
| ESOFC | | G166#4 | ○ | ○ |
| ESOFD | | G178#4 | ○ | ○ |
| ESTB | Read signal for external data input | G002#7 | ○ | ○ |
| ESCAN | Search cancel signal for external data input | F060#2 | ○ | ○ |
| ESTPA | Axis control temporary stop signal (PMC axis control) | G142#5 | ○ | ○ |
| ESTPB | | G154#5 | ○ | ○ |
| ESTPC | | G166#5 | ○ | ○ |
| ESTPD | | G178#5 | ○ | ○ |
| ESTPIO | Slave read/write stop signal | F177#2 | ○ | ○ |
| EVAR | Slave macro variable selection signal | F177#5 | ○ | ○ |
| EWLIO | Slave external write start signal | F177#3 | ○ | ○ |
| EXLM | Stored stroke limit select signal | G007#6 | ○ | ○ |
| EXOFA | Motor activation off status signal (serial spindle) | F047#4 | ○ | ○ |
| EXOFB | | F051#4 | ○ | ○ |
| EXRD | External read start signal | G058#1 | ○ | ○ |
| EXSTP | External read/punch stop signal | G058#2 | ○ | ○ |

| Symbol | Signal name | Address | T series | M series |
|------------------|---|--------------|----------|----------|
| EXWT | External punch start signal | G058#3 | ○ | ○ |
| F1D | F1 – digit feed select signal | G016#7 | – | ○ |
| FIN | Completion signal | G004#3 | ○ | ○ |
| FSCSL | Cs contour control change completion signal | F044#1 | ○ | ○ |
| FSPPH | Spindle phase synchronous control completion signal | F044#3 | ○ | ○ |
| FSPSY | Spindle synchronous speed control completion signal | F044#2 | ○ | ○ |
| G08MD | Advanced preview control mode signal | F066#0 | – | ○ |
| GOQSM | Tool offset value write mode select signal | G039#7 | ○ | – |
| GR1,GR2 | Gear selection signal (input) | G028#1,#2 | ○ | ○ |
| GR1O,GR2O,GR3O | Gear selection signal (output) | F034#0 to #2 | – | ○ |
| GR21 | Gear selection signal (input) | G029#0 | ○ | ○ |
| HDO0 | High–speed skip status signal | F122#0 | ○ | ○ |
| HROV | 1% step rapid traverse override select signal | G096#7 | ○ | ○ |
| HS1A to HS1D | Manual handle feed axis selection signal | G018#0 to #3 | ○ | ○ |
| HS1AO | Software operator's panel signal(HS1A) | F077#0 | ○ | ○ |
| HS1BO | Software operator's panel signal(HS1B) | F077#1 | ○ | ○ |
| HS1CO | Software operator's panel signal(HS1C) | F077#2 | ○ | ○ |
| HS1DO | Software operator's panel signal(HS1D) | F077#3 | ○ | ○ |
| HS1IA to HS1ID | Manual handle interruption axis select signal | G041#0 to #3 | ○ | ○ |
| HS2A to HS2D | Manual handle feed axis selection signal | G018#4 to #7 | ○ | ○ |
| HS2IA to HS2ID | Manual handle interruption axis select signal | G041#4 to #7 | ○ | ○ |
| HS3A to HS3D | Manual handle feed axis selection signal | G019#0 to #3 | ○ | ○ |
| HS3IA to HS3ID | Manual handle interruption axis select signal | G042#0 to #3 | ○ | ○ |
| IGNVRY | All–axis VRDY OFF alarm ignore signal | G066#0 | ○ | ○ |
| IGVRY1 to IGVRY4 | Each–axis VRDY OFF alarm ignore signal | G192 | ○ | ○ |
| INCH | Inch input signal | F002#0 | ○ | ○ |
| INCMDA | Incremental command external setting type orientation signal (serial spindle) | G072#5 | ○ | ○ |
| INCMDB | | G076#5 | ○ | ○ |
| INCSTA | Incremental method orientation signal (serial spindle) | F047#1 | ○ | ○ |
| INCSTB | | F051#1 | ○ | ○ |
| INDXA | Orientation stop position change signal (serial spindle) | G072#0 | ○ | ○ |
| INDXB | | G076#0 | ○ | ○ |
| INHKY | Key input disable signal | F053#0 | ○ | ○ |
| INP1 to INP4 | In–position signal | F104 | ○ | ○ |
| INTGA | Signal for controlling velocity integration (serial spindle) | G071#5 | ○ | ○ |
| INTGB | | G075#5 | ○ | ○ |
| IOLACK | I/O Link confirmation signal | G092#0 | ○ | ○ |
| IOLBH2 | Manual handle feed generator selection signals | G199#0 | ○ | ○ |
| IOLBH3 | | G199#1 | ○ | ○ |
| IOLNK | Slave I/O Link selection signal | F177#0 | ○ | ○ |

| Symbol | Signal name | Address | T series | M series |
|----------------------|--|--------------|----------|----------|
| IOLS | I/O Link specification signal | G092#1 | ○ | ○ |
| IUDD1 to IUDD4 | Abnormal load detection ignore signal | G125 | ○ | ○ |
| KEY1 to KEY4 | Memory protect signal | G046#3 to #6 | ○ | ○ |
| KEYO | Software operator's panel signal(KEY1 to KEY4) | F075#6 | ○ | ○ |
| LDT1A | Load detection signal 1 (serial spindle) | F045#4 | ○ | ○ |
| LDT1B | | F049#4 | ○ | ○ |
| LDT2A | Load detection signal 2 (serial spindle) | F045#5 | ○ | ○ |
| LDT2B | | F049#5 | ○ | ○ |
| M00 to M31 | Miscellaneous function code signal | F010 to F013 | ○ | ○ |
| M200 to M215 | 2nd M function code signal | F014 to F015 | ○ | ○ |
| M300 to M315 | 3rd M function code signal | F016 to F017 | ○ | ○ |
| MA | CNC ready signal | F001#7 | ○ | ○ |
| MABSM | Manual absolute check signal | F004#2 | ○ | ○ |
| MAFL | Miscellaneous function lock check signal | F004#4 | ○ | ○ |
| MBDT1,MBDT2 to MBDT9 | Optional block skip check signal | F004#0,F005 | ○ | ○ |
| MCFNA | Power line switch completion signal (serial spindle) | G071#3 | ○ | ○ |
| MCFNB | | G075#3 | ○ | ○ |
| MCHK | Check mode handle valid signal | G067#3 | ○ | — |
| MD1,MD2,MD4 | Mode selection signal | G043#0 to #2 | ○ | ○ |
| MD1O | Software operator's panel signal(MD1) | F073#0 | ○ | ○ |
| MD2O | Software operator's panel signal(MD2) | F073#1 | ○ | ○ |
| MD4O | Software operator's panel signal(MD4) | F073#2 | ○ | ○ |
| MDRN | Dry run check signal | F002#7 | ○ | ○ |
| MEDT | Memory edit select check signal | F003#6 | ○ | ○ |
| MF | Auxiliary function strobe signal | F007#0 | ○ | ○ |
| MF2 | 2nd M function strobe signal | F008#4 | ○ | ○ |
| MF3 | 3rd M function strobe signal | F008#5 | ○ | ○ |
| MFIN | Auxiliary function completion signal | G005#0 | ○ | ○ |
| MFIN2 | 2nd M function completion signal | G004#4 | ○ | ○ |
| MFIN3 | 3rd M function completion signal | G004#5 | ○ | ○ |
| MFNHGA | Main spindle MCC status signal while changing spindles signal (serial spindle) | G072#6 | ○ | ○ |
| MFNHGB | | G076#6 | ○ | ○ |
| MH | Manual handle feed select check signal | F003#1 | ○ | ○ |
| MI1 to MI4 | Mirror image signal | G106 | ○ | ○ |
| MINC | Incremental feed select check signal | F003#0 | ○ | ○ |
| MINP | External program input start signal | G058#0 | ○ | ○ |
| MJ | JOG feed select check signal | F003#2 | ○ | ○ |
| MLK | All-axis machine lock signal | G044#1 | ○ | ○ |
| MLK1 to MLK4 | Each-axis machine lock signal | G108 | ○ | ○ |
| MLKO | Software operator's panel signal(MLK) | F075#4 | ○ | ○ |

| Symbol | Signal name | Address | T series | M series |
|-------------------|---|-------------------------|----------|----------|
| MMDI | Manual data input select check signal | F003#3 | ○ | ○ |
| MMEM | Automatic operation select check signal | F003#5 | ○ | ○ |
| MMI1 to MMI4 | Mirror image check signal | F108 | ○ | ○ |
| MMLK | All-axis machine lock check signal | F004#1 | ○ | ○ |
| MMOD | Check mode signal | G067#2 | ○ | — |
| MNCHG | Inversion inhibition signal | F091#1 | ○ | — |
| MORA1A | Signal for completion of spindle orientation with a magnetic sensor (serial spindle) | F046#6 | ○ | ○ |
| MORA1B | | F050#6 | ○ | ○ |
| MORA2A | Signal for approximate spindle orientation with a magnetic sensor (serial spindle) | F046#7 | ○ | ○ |
| MORA2B | | F050#7 | ○ | ○ |
| MORCMA | Command for spindle orientation with a magnetic sensor (serial spindle) | G073#0 | ○ | ○ |
| MORCMB | | G077#0 | ○ | ○ |
| MP1,MP2 | Manual handle feed amount selection signal (incremental feed signal) | G019#4,#5 | ○ | ○ |
| MP1O | Software operator's panel signal(MP1) | F076#0 | ○ | ○ |
| MP2O | Software operator's panel signal(MP2) | F076#1 | ○ | ○ |
| MPOFA | Motor power stop signal (serial spindle) | G073#2 | ○ | ○ |
| MPOFB | | G077#2 | ○ | ○ |
| MRDYA | Machine ready signal (serial spindle) | G070#7 | ○ | ○ |
| MRDYB | | G074#7 | ○ | ○ |
| MREF | Manual reference position return selection check signal | F004#5 | ○ | ○ |
| MRMT | DNC operation select check signal | F003#4 | ○ | ○ |
| MRVM | Check mode backward movement inhibition signal | G067#1 | ○ | — |
| MRVMD | Check mode backward movement signal | F091#0 | ○ | — |
| MRVSP | Backward movement inhibition signal | F091#2 | ○ | — |
| MSBK | Single block check signal | F004#3 | ○ | ○ |
| MSDFON | Motor speed detection function enable signal | G016#0 | ○ | ○ |
| MTCHIN | TEACH IN select check signal | F003#7 | ○ | ○ |
| MV1 to MV4 | Axis moving signal | F102 | ○ | ○ |
| MVD1 to MVD4 | Axis moving direction signal | F106 | ○ | ○ |
| NOZAGC | Perpendicular/angular axis control disable signal | G063#5 | ○ | ○ |
| NPOS1 to NPOS4 | Position display neglect signal | G198 | ○ | ○ |
| NRROA | Short-distant movement command while changing the orientation stop position signal (serial spindle) | G072#2 | ○ | ○ |
| NRROB | | G076#2 | ○ | ○ |
| OFN0 to OFN5,OFN6 | Tool offset number select signal | G039#0 to #5, G040#0 | ○ | — |
| OP | Automatic operation signal | F000#7 | ○ | ○ |
| ORARA | Orientation completion signal (serial spindle) | F045#7 | ○ | ○ |
| ORARB | | F049#7 | ○ | ○ |
| ORCMA | Orientation command signal (serial spindle) | G070#6 | ○ | ○ |
| ORCMB | | G074#6 | ○ | ○ |

| Symbol | Signal name | Address | T series | M series |
|----------------------|--|------------------|----------|----------|
| OUT0 to OUT7 | Software operator's panel general-purpose switch signal | F072 | ○ | ○ |
| OVC | Override cancel signal | G006#4 | ○ | ○ |
| OVCE | Override cancellation signal (PMC axis control) | G150#5 | ○ | ○ |
| OVRA | Analog override command signal (serial spindle) | G072#4 | ○ | ○ |
| OVRB | | G076#4 | ○ | ○ |
| PBATL | Absolute position detector battery voltage low alarm signal | F172#7 | ○ | ○ |
| PBATZ | Absolute position detector battery voltage zero alarm signal | F172#6 | ○ | ○ |
| PC1DTA | Signal indicating the status of the detected one-rotation position coder signal (serial spindle) | F047#0 | ○ | ○ |
| PC1DTB | | F051#0 | ○ | ○ |
| PC2SLC | 2nd position coder selection signal | G028#7 | ○ | ○ |
| PECK2 | Small-diameter peck drilling in progress signal | F066#5 | - | ○ |
| PN1,PN2,PN4,PN8,PN16 | Workpiece number search signal | G009#0 to 4 | ○ | ○ |
| PORA2A | Signal for approximate spindle orientation with a position coder (serial spindle) | F046#5 | ○ | ○ |
| PORA2B | | F050#5 | ○ | ○ |
| PRC | Position record signal | G040#6 | ○ | - |
| PRGDPL | program screen display mode signal | F053#1 | ○ | ○ |
| PRTSF | Target parts count reached signal | F062#7 | ○ | ○ |
| PSAR | Spindle polygon speed arrival signal | F063#2 | ○ | - |
| PSE1 | Master axis not arrival signal | F063#0 | ○ | - |
| PSE2 | Polygon synchronous axis not arrival signal | F063#1 | ○ | - |
| PSW01 to PSW16 | Position switch signal | F070#0 to F071#7 | ○ | ○ |
| PSYN | Polygon synchronization under way signal | F063#7 | ○ | - |
| R011 to R121 | Spindle motor speed command signal | G032#0 to G033#3 | ○ | ○ |
| R0112 to R1212 | | G034#0 to G035#3 | ○ | ○ |
| R0113 to R1213 | | G036#0 to G037#3 | ○ | ○ |
| R010 to R120 | S12-bit code signal | F036#0 to F037#3 | ○ | ○ |
| RCFNA | Output switch completion signal (serial spindle) | F046#3 | ○ | ○ |
| RCFNB | | F050#3 | ○ | ○ |
| RCHA | Power line status check signal (serial spindle) | G071#7 | ○ | ○ |
| RCHB | | G075#7 | ○ | ○ |
| RCHHGA | High-output MCC status signal while a magnetic sensor (serial spindle) | G072#7 | ○ | ○ |
| RCHHGB | | G076#7 | ○ | ○ |
| RCHPA | Output switch signal (serial spindle) | F046#2 | ○ | ○ |
| RCHPB | | F050#2 | ○ | ○ |
| RGSPM | Spindle rotation direction signal | F065#1 | - | ○ |
| RGSPB | | F065#0 | - | ○ |
| RGTAP | Rigid tapping signal | G061#0 | ○ | ○ |
| RGTSP1,RGTSP2 | Rigid tapping spindle selection signal | G061#4,#5 | ○ | - |
| RLSOT | Stroke check release signal | G007#7 | - | ○ |

| Symbol | Signal name | Address | T series | M series |
|-------------|---|--------------|----------|----------|
| RLSOT3 | Stroke check 3 release signal | G007#4 | ○ | ○ |
| ROTAA | Rotation direction command while changing the orientation stop position signal (serial spindle) | G072#1 | ○ | ○ |
| ROTAB | | G076#1 | ○ | ○ |
| ROV1,ROV2 | Rapid traverse override signal | G014#0,#1 | ○ | ○ |
| ROV1E,ROV2E | Rapid traverse override signal(PMC axis control) | G150#0,#1 | ○ | ○ |
| ROV1O | Software operator's panel signal(ROV1) | F076#4 | ○ | ○ |
| ROV2O | Software operator's panel signal(ROV2) | F076#5 | ○ | ○ |
| RPALM | Read/punch alarm signal | F053#3 | ○ | ○ |
| RPBSY | Read/punch in-progress signal | F053#2 | ○ | ○ |
| RPDO | Rapid traversing signal | F002#1 | ○ | ○ |
| RRW | Reset&rewind signal | G008#6 | ○ | ○ |
| RSLA | Output switch request signal (serial spindle) | G071#6 | ○ | ○ |
| RSLB | | G075#6 | ○ | ○ |
| RST | Reset signal | F001#1 | ○ | ○ |
| RT | Manual rapid traverse selection signal | G019#7 | ○ | ○ |
| RTAP | Rigid tapping in-progress signal | F076#3 | ○ | ○ |
| RTE | Manual rapid traverse selection signal (PMC axis control) | G150#6 | ○ | ○ |
| RTO | Software operator's panel signal(RT) | F077#6 | ○ | ○ |
| RTNT | Rigid tapping retraction start signal | G062#6 | — | ○ |
| RTPT | Rigid tapping retraction completion signal | F066#1 | — | ○ |
| RVS | Retrace signal | G007#0 | — | ○ |
| RVSL | Retrace-in-progress signal | F082#2 | — | ○ |
| RWD | Rewinding signal | F000#0 | ○ | ○ |
| S00 to S31 | Spindle speed code signal | F022 to F025 | ○ | ○ |
| S1MES | Spindle 1 under measurement signal | F062#3 | ○ | — |
| S2MES | Spindle 2 under measurement signal | F062#4 | ○ | — |
| S2TLS | Spindle measurement select signal | G040#5 | ○ | — |
| SA | Servo ready signal | F000#6 | ○ | ○ |
| SAR | Spindle speed arrival signal | G029#4 | ○ | ○ |
| SARA | Speed arrival signal (serial spindle) | F045#3 | ○ | ○ |
| SARB | | F049#3 | ○ | ○ |
| SBK | Single block signal | G046#1 | ○ | ○ |
| SBKO | Software operator's panel signal(SBK) | F075#3 | ○ | ○ |
| SCLP | Spindle clamp signal | F038#0 | ○ | — |
| SDTA | Speed detection signal (serial spindle) | F045#2 | ○ | ○ |
| SDTB | | F049#2 | ○ | ○ |
| SF | Spindle speed strobe signal | F007#2 | ○ | ○ |
| SFIN | Spindle function completion signal | G005#2 | ○ | ○ |
| SFRA | CW command signal (serial spindle) | G070#5 | ○ | ○ |
| SFRB | | G074#5 | ○ | ○ |

| Symbol | Signal name | Address | T series | M series |
|--------------------------------|---|--------------------|----------|----------|
| SGN | Spindle motor command polarity select signal | G033#5 | ○ | ○ |
| SGN2 | | G035#5 | ○ | ○ |
| SGN3 | | G037#5 | ○ | ○ |
| SHA00 to SHA11 | Spindle orientation external stop position command signal | G078#0 to G079#3 | ○ | ○ |
| SHB00 to SHB11 | | G080#0 to G081#3 | ○ | ○ |
| SIND | Spindle motor speed command select signal | G033#7 | ○ | ○ |
| SIND2 | | G035#7 | ○ | ○ |
| SIND3 | | G037#7 | ○ | ○ |
| SKIP | Skip signal | X004#7 | ○ | ○ |
| | Overload torque signal | X004#7 | — | ○ |
| SKIP2 to SKIP6, SKIP7,SKIP8 | Skip signal | X004#2 to #6,#0,#1 | ○ | ○ |
| SKIPP | | G006#6 | ○ | — |
| SLVA | Slave operation command signal (serial spindle) | G073#1 | ○ | ○ |
| SLVB | | G077#1 | ○ | ○ |
| SLVSA | Slave operation status signal (serial spindle) | F046#4 | ○ | ○ |
| SLVSB | | F050#4 | ○ | ○ |
| SMZ | Error detect signal | G053#6 | ○ | — |
| SOCNA | Soft start/stop cancel signal (serial spindle) | G071#4 | ○ | ○ |
| SOCNB | | G075#4 | ○ | ○ |
| SOR | Spindle orientation signal | G029#5 | ○ | ○ |
| SOV0 to SOV7 | Spindle speed override signal | G030 | ○ | ○ |
| SPAL | Spindle fluctuation detection alarm signal | F035#0 | ○ | ○ |
| SPL | Feed hold lamp signal | F000#4 | ○ | ○ |
| SPO | Software operator's panel signal(*SP) | F075#7 | ○ | ○ |
| SPPHS | Spindle phase synchronous control signal | G038#3 | ○ | ○ |
| SPSLA | Spindle select signal (serial spindle) | G071#2 | ○ | ○ |
| SPSLB | | G075#2 | ○ | ○ |
| SPSTP | Spindle stop complete signal | G028#6 | ○ | — |
| SPSYC | Spindle synchronous control signal | G038#2 | ○ | ○ |
| SRLNI0 to SRLNI3 | Group number specification signals | G091#0 to #3 | ○ | ○ |
| SRLNO0 to SRLNO3 | Group number output signals | F178#0 to #3 | ○ | ○ |
| SRN | Program restart signal | G006#0 | ○ | ○ |
| SRNMV | Program restart under way signal | F002#4 | ○ | ○ |
| SRVA | CCW command signal (serial spindle) | G070#4 | ○ | ○ |
| SRVB | | G074#4 | ○ | ○ |
| SSIN | Spindle motor command polarity select signal | G033#6 | ○ | ○ |
| SSIN2 | | G035#6 | ○ | ○ |
| SSIN3 | | G037#6 | ○ | ○ |

| Symbol | Signal name | Address | T series | M series |
|------------------|---|------------------|----------|----------|
| SSTA | Speed zero signal (serial spindle) | F045#1 | ○ | ○ |
| SSTB | | F049#1 | ○ | ○ |
| ST | Cycle start lamp signal | G007#2 | ○ | ○ |
| STL | Cycle start signal | F000#5 | ○ | ○ |
| STLK | Start lock signal | G007#1 | ○ | — |
| STRD | Input and run simultaneous mode select signal | G058#5 | — | ○ |
| STWD | Output and run simultaneous mode select signal | G058#6 | — | ○ |
| SUCLP | Spindle unclamp signal | F038#1 | ○ | — |
| SVF1 to SVF4 | Servo off signal | G126 | ○ | ○ |
| SWS1 | Spindle selection signals | G027#0 | ○ | ○ |
| SWS2 | | G027#1 | ○ | ○ |
| SWS3 | | G027#2 | ○ | ○ |
| SYCAL | Phase error monitor signal | F044#4 | ○ | ○ |
| SYNC1 to SYNC4 | Simple synchronous axis select signal | G138 | ○ | ○ |
| SYNCJ1 to SYNCJ4 | Simple synchronous manual feed axis select signal | G140 | — | ○ |
| T00 to T31 | Tool function code signal | F026 to F029 | ○ | ○ |
| TAP | Tapping signal | F001#5 | ○ | ○ |
| TF | Tool function strobe signal | F007#3 | ○ | ○ |
| TFIN | Tool function completion signal | G005#3 | ○ | ○ |
| THRD | Thread cutting signal | F002#3 | ○ | ○ |
| TL01 to TL64 | Tool group number select signal | G047#0 to #6 | ○ | — |
| TL01 to TL256 | | G047#0 to G048#0 | — | ○ |
| TLCH | Tool change signal | F064#0 | ○ | ○ |
| TLCHB | Tool life arrival notice signal | F064#3 | — | ○ |
| TLCHI | Individual tool change signal | F064#2 | — | ○ |
| TLMA | Torque limit signal (serial spindle) | F045#6 | ○ | ○ |
| TLMB | | F049#6 | ○ | ○ |
| TLMHA | Torque limit command HIGH signal (serial spindle) | G070#1 | ○ | ○ |
| TLMHB | | G074#1 | ○ | ○ |
| TLMLA | Torque limit command LOW signal (serial spindle) | G070#0 | ○ | ○ |
| TLMLB | | G074#0 | ○ | ○ |
| TLNW | New tool select signal | F064#1 | ○ | ○ |
| TLRST | Tool change reset signal | G048#7 | ○ | ○ |
| TLRSTI | Individual tool change reset signal | G048#6 | — | ○ |
| TLSKP | Tool skip signal | G048#5 | ○ | ○ |
| TMRON | General-purpose integrating meter start signal | G053#0 | ○ | ○ |
| TRQL1 to TRQL4 | Torque limit reached signal | F114 | ○ | — |
| UI000 to UI015 | Input signal for custom macro | G054,G055 | ○ | ○ |
| UINT | Interrupt signal for custom macro | G053#3 | ○ | ○ |

| Symbol | Signal name | Address | T series | M series |
|----------------|--|--------------|----------|----------|
| UO000 to UO015 | Output signal for custom macro | F054,F055 | ○ | ○ |
| UO100 to UO131 | | F056 to F059 | ○ | ○ |
| WOQSM | Workpiece coordinate system shift value write mode select signal | G039#6 | ○ | — |
| WOSET | Workpiece coordinate system shift value write signal | G040#7 | ○ | — |
| XAE | Measuring position reached signal | X004#0 | ○ | ○ |
| YAE | | X004#1 | — | ○ |
| ZAE | | X004#1 | ○ | — |
| ZAE | | X004#2 | — | ○ |
| ZP1 to ZP4 | Reference position return end signal | F094 | ○ | ○ |
| ZP21 to ZP24 | 2nd reference position return end signal | F096 | ○ | ○ |
| ZP31 to ZP34 | 3rd reference position return end signal | F098 | ○ | ○ |
| ZP41 to ZP44 | 4th reference position return end signal | F100 | ○ | ○ |
| ZRF1 to ZRF4 | Reference position establishment signal | F120 | ○ | ○ |
| ZRN | Manual reference position return selection signal | G043#7 | ○ | ○ |
| ZRNO | Software operator's panel signal(ZRN) | F073#4 | ○ | ○ |

4.7 LIST OF ADDRESSES

● **Address list**

For a signal that is common to the M series and T series, and is usable for only one of the two series, hatching is provided on the upper part (the T series) or lower part (M series) for which the signal is not usable, as shown below.

[Example 1] EXLM and ST are signals common to the T series and M series. STLK is a signal usable only for the T series. RLSOT and RVS are signals usable only for the M series.

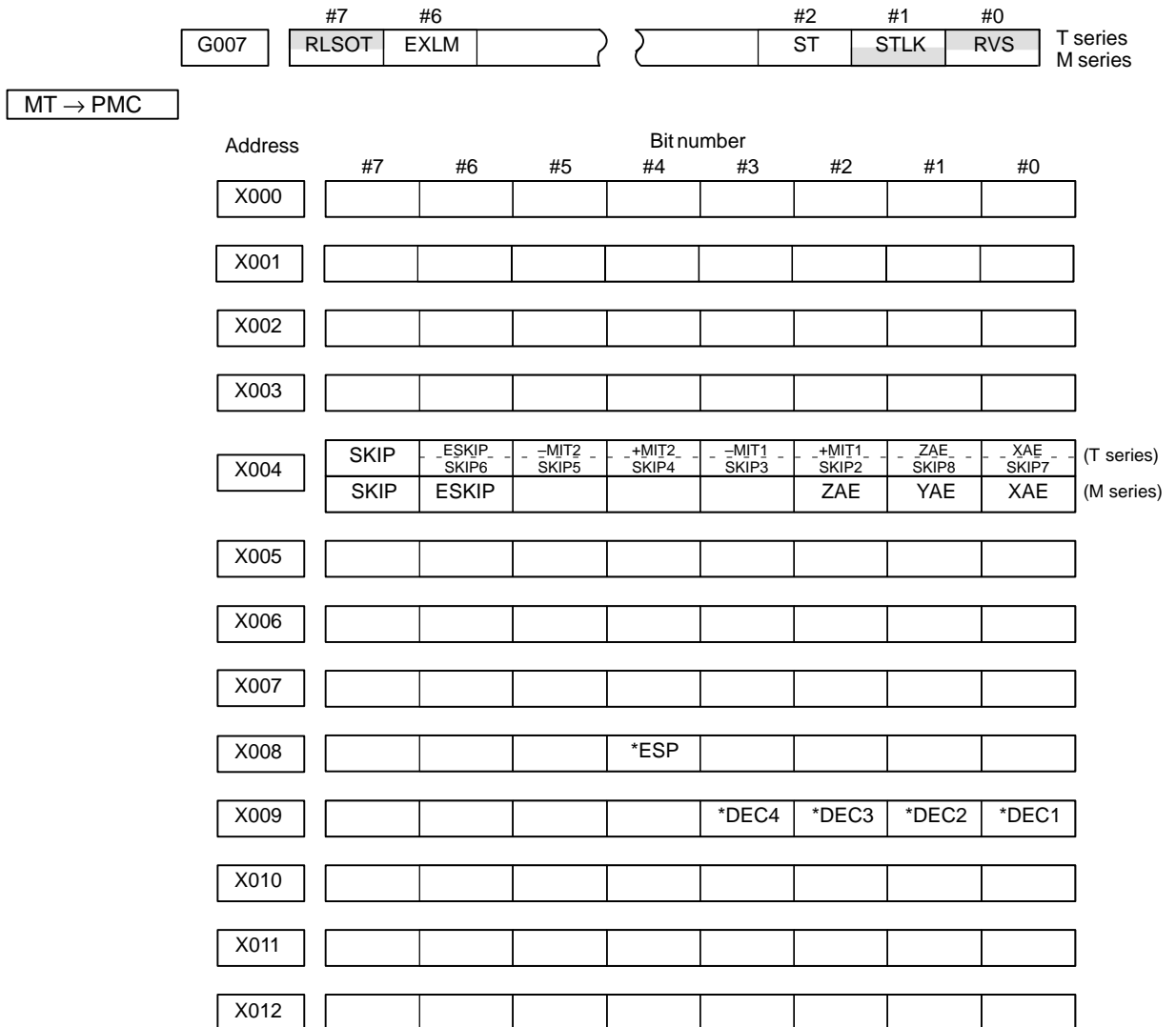

● T series/M series

PMC → CNC

| Address | Bit number | | | | | | | |
|---------|------------|-------|-------|--------|-------|-------|------|--------|
| | #7 | #6 | #5 | #4 | #3 | #2 | #1 | #0 |
| G000 | ED7 | ED6 | ED5 | ED4 | ED3 | ED2 | ED1 | ED0 |
| G001 | ED15 | ED14 | ED13 | ED12 | ED11 | ED10 | ED9 | ED8 |
| G002 | ESTB | EA6 | EA5 | EA4 | EA3 | EA2 | EA1 | EA0 |
| G003 | | | | | | | | |
| G004 | | | MFIN3 | MFIN2 | FIN | | | |
| G005 | BFIN | AFL | | BFIN | TFIN | SFIN | EFIN | MFIN |
| G006 | | SKIPP | | OVC | | *ABSM | | SRN |
| G007 | RLSOT | EXLM | *FLWU | RLSOT3 | | ST | STLK | |
| G008 | ERS | RRW | *SP | *ESP | *BSL | | *CSL | *IT |
| G009 | | | | PN16 | PN8 | PN4 | PN2 | PN1 |
| G010 | *JV7 | *JV6 | *JV5 | *JV4 | *JV3 | *JV2 | *JV1 | *JV0 |
| G011 | *JV15 | *JV14 | *JV13 | *JV12 | *JV11 | *JV10 | *JV9 | *JV8 |
| G012 | *FV7 | *FV6 | *FV5 | *FV4 | *FV3 | *FV2 | *FV1 | *FV0 |
| G013 | | | | | | | | |
| G014 | | | | | | | ROV2 | ROV1 |
| G015 | | | | | | | | |
| G016 | F1D | | | | | | | MSDFON |
| G017 | | | | | | | | |
| G018 | HS2D | HS2C | HS2B | HS2A | HS1D | HS1C | HS1B | HS1A |
| G019 | RT | | MP2 | MP1 | HS3D | HS3C | HS3B | HS3A |
| G020 | | | | | | | | |
| G021 | | | | | | | | |
| G022 | | | | | | | | |
| G023 | | | | | | | | |
| G024 | EPN7 | EPN6 | EPN5 | EPN4 | EPN3 | EPN2 | EPN1 | EPN0 |

| | #7 | #6 | #5 | #4 | #3 | #2 | #1 | #0 |
|------|--------|--------|--------|--------|--------|-------|-------|-------|
| G025 | EPNS | | EPN13 | EPN12 | EPN11 | EPN10 | EPN9 | EPN8 |
| G026 | | | | | | | | |
| G027 | CON | | *SSTP3 | *SSTP2 | *SSTP1 | SWS3 | SWS2 | SWS1 |
| G028 | PC2SLC | SPSTP | *SCPF | *SUCPF | | GR2 | GR1 | |
| G029 | | *SSTP | SOR | SAR | | | | GR21 |
| G030 | SOV7 | SOV6 | SOV5 | SOV4 | SOV3 | SOV2 | SOV1 | SOV0 |
| G031 | | | | | | | | |
| G032 | R08I | R07I | R06I | R05I | R04I | R03I | R02I | R01I |
| G033 | SIND | SSIN | SGN | | R12I | R11I | R10I | R09I |
| G034 | R08I2 | R07I2 | R06I2 | R05I2 | R04I2 | R03I2 | R02I2 | R01I2 |
| G035 | SIND2 | SSIN2 | SGN2 | | R12I2 | R11I2 | R10I2 | R09I2 |
| G036 | R08I3 | R07I3 | R06I3 | R05I3 | R04I3 | R03I3 | R02I3 | R01I3 |
| G037 | SIND3 | SSIN3 | SGN3 | | R12I3 | R11I3 | R10I3 | R09I3 |
| G038 | *BECLP | *BEUCP | | | SPPHS | SPSYC | | |
| G039 | GOQSM | WOQSM | OFN5 | OFN4 | OFN3 | OFN2 | OFN1 | OFN0 |
| G040 | WOSET | PRC | S2TLS | | | | | |
| G041 | HS2ID | HS2IC | HS2IB | HS2IA | HS1ID | HS1IC | HS1IB | HS1IA |
| G042 | DMMC | | | | HS3ID | HS3IC | HS3IB | HS3IA |
| G043 | ZRN | | DNCI | | | MD4 | MD2 | MD1 |
| G044 | | | | | | | MLK | BDT1 |
| G045 | BDT9 | BDT8 | BDT7 | BDT6 | BDT5 | BDT4 | BDT3 | BDT2 |
| G046 | DRN | KEY4 | KEY3 | KEY2 | KEY1 | | SBK | |
| G047 | TL128 | TL64 | TL32 | TL16 | TL08 | TL04 | TL02 | TL01 |
| G048 | TLRST | TLRSTI | TLSKP | | | | | TL256 |
| G049 | *TLV7 | *TLV6 | *TLV5 | *TLV4 | *TLV3 | *TLV2 | *TLV1 | *TLV0 |

| | #7 | #6 | #5 | #4 | #3 | #2 | #1 | #0 |
|------|-------|--------|--------|-------|--------|-------|--------|--------|
| G050 | | | | | | | *TLV9 | *TLV8 |
| G051 | | | | | | | | |
| G052 | | | | | | | | |
| G053 | CDZ | SMZ | | | UINT | | | TMRON |
| G054 | UI007 | UI006 | UI005 | UI004 | UI003 | UI002 | UI001 | UI000 |
| G055 | UI015 | UI014 | UI013 | UI012 | UI011 | UI010 | UI009 | UI008 |
| G056 | | | | | | | | |
| G057 | | | | | | | | |
| G058 | | | | | EXWT | EXSTP | EXRD | MINP |
| G059 | | | | | | | | |
| G060 | *TSB | | | | | | | |
| G061 | | | RGTS2 | RGTS1 | | | | RGTA |
| G062 | | RTNT | | | | | *CRTOF | |
| G063 | | | NOZAGC | | | | | |
| G064 | | | | | | | | |
| G065 | | | | | | | | |
| G066 | EKSET | | | | | | ENBKY | IGNVRY |
| G067 | | | | | | | | |
| G068 | | | | | | | | |
| G069 | | | | | | | | |
| G070 | MRDYA | ORCMA | SFRA | SRVA | CTH1A | CTH2A | TLMHA | TLMLA |
| G071 | RCHA | RSLA | INTGA | SOCNA | MCFNA | SPSLA | *ESPA | ARSTA |
| G072 | RCHGA | MFNHGA | INCMDA | OVRA | DEFMDA | NRROA | ROTAA | INDXA |
| G073 | | | | DSCNA | | MPOFA | SLVA | MORCMA |
| G074 | MRDYB | ORCMB | SFRB | SRVB | CTH1B | CTH2B | TLMHB | TLMLB |

| | #7 | #6 | #5 | #4 | #3 | #2 | #1 | #0 |
|------|-------------------------------|--------|--------|--------|--------|--------|--------|--------|
| G075 | RCHB | RSLB | INTGB | SOCNB | MCFNB | SPSLB | *ESPB | ARSTB |
| G076 | RCHHGB | MFNHGB | INCMDB | OVRB | DEFMDB | NRROB | ROTAB | INDXB |
| G077 | | | | DSCNB | | MPOFB | SLVB | MORCMB |
| G078 | SHA07 | SHA06 | SHA05 | SHA04 | SHA03 | SHA02 | SHA01 | SHA00 |
| G079 | | | | | SHA11 | SHA10 | SHA09 | SHA08 |
| G080 | SHB07 | SHB06 | SHB05 | SHB04 | SHB03 | SHB02 | SHB01 | SHB00 |
| G081 | | | | | SHB11 | SHB10 | SHB09 | SHB08 |
| G082 | Reserved for order-made macro | | | | | | | |
| G083 | Reserved for order-made macro | | | | | | | |
| G084 | | | | | | | | |
| G085 | | | | | | | | |
| G086 | | | | | | | | |
| G087 | | | | | | | | |
| G088 | | | | | | | | |
| G089 | | | | | | | | |
| G090 | | | | | | | | |
| G091 | | | | | SRLNI3 | SRLNI2 | SRLNI1 | SRLNI0 |
| G092 | | | | BGEN | BGIALM | BGION | IOLS | IOLACK |
| G093 | | | | | | | | |
| G094 | | | | | | | | |
| G095 | | | | | | | | |
| G096 | HROV | *HROV6 | *HROV5 | *HROV4 | *HROV3 | *HROV2 | *HROV1 | *HROV0 |
| G097 | | | | | | | | |
| G098 | EKC7 | EKC6 | EKC5 | EKC4 | EKC3 | EKC2 | EKC1 | EKC0 |
| G099 | | | | | | | | |

| | #7 | #6 | #5 | #4 | #3 | #2 | #1 | #0 |
|------|----|----|----|----|-------|-------|-------|-------|
| G100 | | | | | +J4 | +J3 | +J2 | +J1 |
| G101 | | | | | | | | |
| G102 | | | | | -J4 | -J3 | -J2 | -J1 |
| G103 | | | | | | | | |
| G104 | | | | | +EXL4 | +EXL3 | +EXL2 | +EXL1 |
| G105 | | | | | -EXL4 | -EXL3 | -EXL2 | -EXL1 |
| G106 | | | | | MI4 | MI3 | MI2 | MI1 |
| G107 | | | | | | | | |
| G108 | | | | | MLK4 | MLK3 | MLK2 | MLK1 |
| G109 | | | | | | | | |
| G110 | | | | | +LM4 | +LM3 | +LM2 | +LM1 |
| G111 | | | | | | | | |
| G112 | | | | | -LM4 | -LM3 | -LM2 | -LM1 |
| G113 | | | | | | | | |
| G114 | | | | | *+L4 | *+L3 | *+L2 | *+L1 |
| G115 | | | | | | | | |
| G116 | | | | | *-L4 | *-L3 | *-L2 | *-L1 |
| G117 | | | | | | | | |
| G118 | | | | | *+ED4 | *+ED3 | *+ED2 | *+ED1 |
| G119 | | | | | | | | |
| G120 | | | | | *-ED4 | *-ED3 | *-ED2 | *-ED1 |
| G121 | | | | | | | | |
| G122 | | | | | | | | |
| G123 | | | | | | | | |

| | #7 | #6 | #5 | #4 | #3 | #2 | #1 | #0 |
|------|--------|--------|--------|--------|--------|--------|--------|--------|
| G124 | | | | | | | | |
| G125 | | | | | IUDD4 | IUDD3 | IUDD2 | IUDD1 |
| G126 | | | | | SVF4 | SVF3 | SVF2 | SVF1 |
| G127 | | | | | | | | |
| G128 | | | | | | | | |
| G129 | | | | | | | | |
| G130 | | | | | *IT4 | *IT3 | *IT2 | *IT1 |
| G131 | | | | | | | | |
| G132 | | | | | +MIT4 | +MIT3 | +MIT2 | +MIT1 |
| G133 | | | | | | | | |
| G134 | | | | | -MIT4 | -MIT3 | -MIT2 | -MIT1 |
| G135 | | | | | | | | |
| G136 | | | | | EAX4 | EAX3 | EAX2 | EAX1 |
| G137 | | | | | | | | |
| G138 | | | | | SYNC4 | SYNC3 | SYNC2 | SYNC1 |
| G139 | | | | | | | | |
| G140 | | | | | SYNCJ4 | SYNCJ3 | SYNCJ2 | SYNCJ1 |
| G141 | | | | | | | | |
| G142 | EBUFA | ECLRA | ESTPA | ESOFA | ESBKA | EMBUFA | ELCKZA | EFINA |
| G143 | EMSBKA | EC6A | EC5A | EC4A | EC3A | EC2A | EC1A | EC0A |
| G144 | EIF7A | EIF6A | EIF5A | EIF4A | EIF3A | EIF2A | EIF1A | EIF0A |
| G145 | EIF15A | EIF14A | EIF13A | EIF12A | EIF11A | EIF10A | EIF9A | EIF8A |
| G146 | EID7A | EID6A | EID5A | EID4A | EID3A | EID2A | EID1A | EID0A |
| G147 | EID15A | EID14A | EID13A | EID12A | EID11A | EID10A | EID9A | EID8A |
| G148 | EID23A | EID22A | EID21A | EID20A | EID19A | EID18A | EID17A | EID16A |

| | #7 | #6 | #5 | #4 | #3 | #2 | #1 | #0 |
|------|--------|--------|--------|--------|--------|--------|--------|--------|
| G149 | EID31A | EID30A | EID29A | EID28A | EID27A | EID26A | EID25A | EID24A |
| G150 | DRNE | RTE | OVCE | | | | ROV2E | ROV1E |
| G151 | *FV7E | *FV6E | *FV5E | *FV4E | *FV3E | *FV2E | *FV1E | *FV0E |
| G152 | | | | | | | | |
| G153 | | | | | | | | |
| G154 | EBUFB | ECLRB | ESTPB | ESOFB | ESBKB | EMBUFB | ELCKZB | EFINB |
| G155 | EMSBKB | EC6B | EC5B | EC4B | EC3B | EC2B | EC1B | EC0B |
| G156 | EIF7B | EIF6B | EIF5B | EIF4B | EIF3B | EIF2B | EIF1B | EIF0B |
| G157 | EIF15B | EIF14B | EIF13B | EIF12B | EIF11B | EIF10B | EIF9B | EIF8B |
| G158 | EID7B | EID6B | EID5B | EID4B | EID3B | EID2B | EID1B | EID0B |
| G159 | EID15B | EID14B | EID13B | EID12B | EID11B | EID10B | EID9B | EID8B |
| G160 | EID23B | EID22B | EID21B | EID20B | EID19B | EID18B | EID17B | EID16B |
| G161 | EID31B | EID30B | EID29B | EID28B | EID27B | EID26B | EID25B | EID24B |
| G162 | | | | | | | | |
| G163 | | | | | | | | |
| G164 | | | | | | | | |
| G165 | | | | | | | | |
| G166 | EBUFC | ECLRC | ESTPC | ESOFC | ESBKC | EMBUFC | ELCKZC | EFINC |
| G167 | EMSBKC | EC6C | EC5C | EC4C | EC3C | EC2C | EC1C | EC0C |
| G168 | EIF7C | EIF6C | EIF5C | EIF4C | EIF3C | EIF2C | EIF1C | EIF0C |
| G169 | EIF15C | EIF14C | EIF13C | EIF12C | EIF11C | EIF10C | EIF9C | EIF8C |
| G170 | EID7C | EID6C | EID5C | EID4C | EID3C | EID2C | EID1C | EID0C |
| G171 | EID15C | EID14C | EID13C | EID12C | EID11C | EID10C | EID9C | EID8C |
| G172 | EID23C | EID22C | EID21C | EID20C | EID19C | EID18C | EID17C | EID16C |
| G173 | EID31C | EID30C | EID29C | EID28C | EID27C | EID26C | EID25C | EID24C |

| | #7 | #6 | #5 | #4 | #3 | #2 | #1 | #0 |
|------|--------|--------|--------|--------|--------|--------|--------|--------|
| G174 | | | | | | | | |
| G175 | | | | | | | | |
| G176 | | | | | | | | |
| G177 | | | | | | | | |
| G178 | EBUFD | ECLRD | ESTPD | ESOFD | ESBKD | EMBUFD | ELCKZD | EFIND |
| G179 | EMSBKD | EC6D | EC5D | EC4D | EC3D | EC2D | EC1D | EC0D |
| G180 | EIF7D | EIF6D | EIF5D | EIF4D | EIF3D | EIF2D | EIF1D | EIF0D |
| G181 | EIF15D | EIF14D | EIF13D | EIF12D | EIF11D | EIF10D | EIF9D | EIF8D |
| G182 | EID7D | EID6D | EID5D | EID4D | EID3D | EID2D | EID1D | EID0D |
| G183 | EID15D | EID14D | EID13D | EID12D | EID11D | EID10D | EID9D | EID8D |
| G184 | EID23D | EID22D | EID21D | EID20D | EID19D | EID18D | EID17D | EID16D |
| G185 | EID31D | EID30D | EID29D | EID28D | EID27D | EID26D | EID25D | EID24D |
| G186 | | | | | | | | |
| G187 | | | | | | | | |
| G188 | | | | | | | | |
| G189 | | | | | | | | |
| G190 | | | | | | | | |
| G191 | | | | | | | | |
| G192 | | | | | IGVRY4 | IGVRY3 | IGVRY2 | IGVRY1 |
| G193 | | | | | | | | |
| G194 | | | | | | | | |
| G195 | | | | | | | | |
| G196 | | | | | | | | |
| G197 | | | | | | | | |
| G198 | | | | | NPOS4 | NPOS3 | NPOS2 | NPOS1 |

| | #7 | #6 | #5 | #4 | #3 | #2 | #1 | #0 |
|------|----|----|----|----|--------|--------|--------|--------|
| G199 | | | | | | | | |
| G200 | | | | | EASIP4 | EASIP3 | EASIP2 | EASIP1 |
| G201 | | | | | | | | |
| G202 | | | | | | | | |
| G203 | | | | | | | | |
| G204 | | | | | | | | |
| G205 | | | | | | | | |
| G206 | | | | | | | | |
| G207 | | | | | | | | |
| G208 | | | | | | | | |
| G209 | | | | | | | | |
| G210 | | | | | | | | |
| G211 | | | | | | | | |
| G212 | | | | | | | | |
| G213 | | | | | | | | |
| G214 | | | | | | | | |
| G215 | | | | | | | | |
| G216 | | | | | | | | |
| G217 | | | | | | | | |
| G218 | | | | | | | | |
| G219 | | | | | | | | |
| G220 | | | | | | | | |
| G221 | | | | | | | | |
| G222 | | | | | | | | |
| G223 | | | | | | | | |

| | #7 | #6 | #5 | #4 | #3 | #2 | #1 | #0 |
|------|----|----|----|----|----|----|----|----|
| G224 | | | | | | | | |
| G225 | | | | | | | | |
| G226 | | | | | | | | |
| G227 | | | | | | | | |
| G228 | | | | | | | | |
| G229 | | | | | | | | |
| G230 | | | | | | | | |
| G231 | | | | | | | | |
| G232 | | | | | | | | |
| G233 | | | | | | | | |
| G234 | | | | | | | | |
| G235 | | | | | | | | |
| G236 | | | | | | | | |
| G237 | | | | | | | | |
| G238 | | | | | | | | |
| G239 | | | | | | | | |
| G240 | | | | | | | | |
| G241 | | | | | | | | |
| G242 | | | | | | | | |
| G243 | | | | | | | | |
| G244 | | | | | | | | |
| G245 | | | | | | | | |
| G246 | | | | | | | | |
| G247 | | | | | | | | |
| G248 | | | | | | | | |

| | #7 | #6 | #5 | #4 | #3 | #2 | #1 | #0 |
|------|----|----|----|----|----|----|----|----|
| G249 | | | | | | | | |
| G250 | | | | | | | | |
| G251 | | | | | | | | |
| G252 | | | | | | | | |
| G253 | | | | | | | | |
| G254 | | | | | | | | |
| G255 | | | | | | | | |
| G256 | | | | | | | | |
| G257 | | | | | | | | |
| G258 | | | | | | | | |
| G259 | | | | | | | | |
| G260 | | | | | | | | |
| G261 | | | | | | | | |
| G262 | | | | | | | | |
| G263 | | | | | | | | |
| G264 | | | | | | | | |
| G265 | | | | | | | | |
| G266 | | | | | | | | |
| G267 | | | | | | | | |
| G268 | | | | | | | | |
| G269 | | | | | | | | |
| G270 | | | | | | | | |
| G271 | | | | | | | | |
| G272 | | | | | | | | |
| G273 | | | | | | | | |

| | #7 | #6 | #5 | #4 | #3 | #2 | #1 | #0 |
|------|----|----|----|----|----|----|----|----|
| G274 | | | | | | | | |
| G275 | | | | | | | | |
| G276 | | | | | | | | |
| G277 | | | | | | | | |
| G278 | | | | | | | | |
| G279 | | | | | | | | |
| G280 | | | | | | | | |
| G281 | | | | | | | | |
| G282 | | | | | | | | |
| G283 | | | | | | | | |
| G284 | | | | | | | | |
| G285 | | | | | | | | |
| G286 | | | | | | | | |
| G287 | | | | | | | | |
| G288 | | | | | | | | |
| G289 | | | | | | | | |
| G290 | | | | | | | | |
| G291 | | | | | | | | |
| G292 | | | | | | | | |
| G293 | | | | | | | | |
| G294 | | | | | | | | |
| G295 | | | | | | | | |
| G296 | | | | | | | | |
| G297 | | | | | | | | |
| G298 | | | | | | | | |

| | #7 | #6 | #5 | #4 | #3 | #2 | #1 | #0 |
|------|----|----|----|----|----|----|----|----|
| G299 | | | | | | | | |
| G300 | | | | | | | | |
| G301 | | | | | | | | |
| G302 | | | | | | | | |
| G303 | | | | | | | | |
| G304 | | | | | | | | |
| G305 | | | | | | | | |
| G306 | | | | | | | | |
| G307 | | | | | | | | |
| G308 | | | | | | | | |
| G309 | | | | | | | | |
| G310 | | | | | | | | |
| G311 | | | | | | | | |

CNC → PMC

| Address | Bit number | | | | | | | |
|---------|------------|-------|-------|-------|-------|-------|-------|-------|
| | #7 | #6 | #5 | #4 | #3 | #2 | #1 | #0 |
| F000 | OP | SA | STL | SPL | | | | RWD |
| F001 | MA | | TAP | ENB | DEN | BAL | RST | AL |
| F002 | MDRN | CUT | | SRNMV | THRD | CSS | RPDO | INCH |
| F003 | MTCHIN | MEDT | MMEM | MRMT | MMDI | MJ | MH | MINC |
| F004 | | | MREF | MAFL | MSBK | MABSM | MMLK | MBDT1 |
| F005 | MBDT9 | MBDT8 | MBDT7 | MBDT6 | MBDT5 | MBDT4 | MBDT3 | MBDT2 |
| F006 | | | | | | | | |
| F007 | BF | | | BF | TF | SF | EFD | MF |
| F008 | | | MF3 | MF2 | | | | EF |
| F009 | DM00 | DM01 | DM02 | DM30 | | | | |
| F010 | M07 | M06 | M05 | M04 | M03 | M02 | M01 | M00 |
| F011 | M15 | M14 | M13 | M12 | M11 | M10 | M09 | M08 |
| F012 | M23 | M22 | M21 | M20 | M19 | M18 | M17 | M16 |
| F013 | M31 | M30 | M29 | M28 | M27 | M26 | M25 | M24 |
| F014 | M207 | M206 | M205 | M204 | M203 | M202 | M201 | M200 |
| F015 | M215 | M214 | M213 | M212 | M211 | M210 | M209 | M208 |
| F016 | M307 | M306 | M305 | M304 | M303 | M302 | M301 | M300 |
| F017 | M315 | M314 | M313 | M312 | M311 | M310 | M309 | M308 |
| F018 | | | | | | | | |
| F019 | | | | | | | | |
| F020 | | | | | | | | |
| F021 | | | | | | | | |
| F022 | S07 | S06 | S05 | S04 | S03 | S02 | S01 | S00 |
| F023 | S15 | S14 | S13 | S12 | S11 | S10 | S09 | S08 |
| F024 | S23 | S22 | S21 | S20 | S19 | S18 | S17 | S16 |

| | #7 | #6 | #5 | #4 | #3 | #2 | #1 | #0 |
|------|--------|--------|--------|-------|-------|-------|--------|--------|
| F025 | S31 | S30 | S29 | S28 | S27 | S26 | S25 | S24 |
| F026 | T07 | T06 | T05 | T04 | T03 | T02 | T01 | T00 |
| F027 | T15 | T14 | T13 | T12 | T11 | T10 | T09 | T08 |
| F028 | T23 | T22 | T21 | T20 | T19 | T18 | T17 | T16 |
| F029 | T31 | T30 | T29 | T28 | T27 | T26 | T25 | T24 |
| F030 | B07 | B06 | B05 | B04 | B03 | B02 | B01 | B00 |
| F031 | B15 | B14 | B13 | B12 | B11 | B10 | B09 | B08 |
| F032 | B23 | B22 | B21 | B20 | B19 | B18 | B17 | B16 |
| F033 | B31 | B30 | B29 | B28 | B27 | B26 | B25 | B24 |
| F034 | | | | | | GR30 | GR20 | GR10 |
| F035 | | | | | | | | SPAL |
| F036 | R08O | R07O | R06O | R05O | R04O | R03O | R02O | R01O |
| F037 | | | | | R12O | R11O | R10O | R09O |
| F038 | | | | | ENB3 | ENB2 | SUCLP | SCLP |
| F039 | | | | | | | | |
| F040 | AR7 | AR6 | AR5 | AR4 | AR3 | AR2 | AR1 | AR0 |
| F041 | AR15 | AR14 | AR13 | AR12 | AR11 | AR10 | AR09 | AR08 |
| F042 | | | | | | | | |
| F043 | | | | | | | | |
| F044 | | | | SYCAL | FSPPH | FSPSY | FSCSL | |
| F045 | ORARA | TLMA | LDT2A | LDT1A | SARA | SDTA | SSTA | ALMA |
| F046 | MORA2A | MORA1A | PORA2A | SLVSA | RCFNA | RCHPA | CFINA | CHPA |
| F047 | | | | EXOFA | | | INCSTA | PC1DTA |
| F048 | | | | | | | | |
| F049 | ORARB | TLMB | LDT2B | LDT1B | SARB | SDTB | SSTB | ALMB |

| | #7 | #6 | #5 | #4 | #3 | #2 | #1 | #0 |
|------|--------|--------|--------|--------|-------|-------|--------|--------|
| F050 | MORA2B | MORA1B | PORA2B | SLVSB | RCFNB | RCHPB | CFINB | CHPB |
| F051 | | | | EXOFB | | | INCSTB | PC1DTB |
| F052 | | | | | | | | |
| F053 | EKENB | | | BGEACT | RPALM | RPBSY | PRGDPL | INHKY |
| F054 | UO007 | UO006 | UO005 | UO004 | UO003 | UO002 | UO001 | UO000 |
| F055 | UO015 | UO014 | UO013 | UO012 | UO011 | UO010 | UO009 | UO008 |
| F056 | UO107 | UO106 | UO105 | UO104 | UO103 | UO102 | UO101 | UO100 |
| F057 | UO115 | UO114 | UO113 | UO112 | UO111 | UO110 | UO109 | UO108 |
| F058 | UO123 | UO122 | UO121 | UO120 | UO119 | UO118 | UO117 | UO116 |
| F059 | UO131 | UO130 | UO129 | UO128 | UO127 | UO126 | UO125 | UO124 |
| F060 | | | | | | ESCAN | ESEND | EREND |
| F061 | | | | | | | BCLP | BUCLP |
| F062 | PRTSF | | | S2MES | S1MES | | | AICC |
| F063 | PSYN | | | | | | | |
| F064 | | | | | | TLCHI | TLNW | TLCH |
| F065 | | | | | | | RGSPM | RGSP |
| F066 | | | PECK2 | | | | RTPT | G08MD |
| F067 | | | | | | | | |
| F068 | | | | | | | | |
| F069 | | | | | | | | |
| F070 | PSW08 | PSW07 | PSW06 | PSW05 | PSW04 | PSW03 | PSW02 | PSW01 |
| F071 | PSW16 | PSW15 | PSW14 | PSW13 | PSW12 | PSW11 | PSW10 | PSW09 |
| F072 | OUT7 | OUT6 | OUT5 | OUT4 | OUT3 | OUT2 | OUT1 | OUT0 |
| F073 | | | | ZRNO | | MD40 | MD20 | MD10 |
| F074 | | | | | | | | |

| | #7 | #6 | #5 | #4 | #3 | #2 | #1 | #0 |
|------|--------|--------|--------|--------|--------|--------|--------|--------|
| F075 | SPO | KEYO | DRNO | MLKO | SBKO | BDTO | | |
| F076 | | | ROV2O | ROV1O | RTAP | | MP2O | MP1O |
| F077 | | RTO | | | HS1DO | HS1CO | HS1BO | HS1AO |
| F078 | *FV7O | *FV6O | *FV5O | *FV4O | *FV3O | *FV2O | *FV1O | *FV0O |
| F079 | *JV7O | *JV6O | *JV5O | *JV4O | *JV3O | *JV2O | *JV1O | *JV0O |
| F080 | *JV15O | *JV14O | *JV13O | *JV12O | *JV11O | *JV10O | *JV9O | *JV8O |
| F081 | - J4O | + J4O | - J3O | + J3O | - J2O | + J2O | - J1O | + J1O |
| F082 | | | | | | | | |
| F083 | | | | | | | | |
| F084 | | | | | | | | |
| F085 | | | | | | | | |
| F086 | | | | | | | | |
| F087 | | | | | | | | |
| F088 | | | | | | | | |
| F089 | | | | | | | | |
| F090 | | | | | | ABTSP2 | ABTSP1 | ABTQSV |
| F091 | | | | | | | | |
| F092 | | | | | | | | |
| F093 | | | | | | | | |
| F094 | | | | | ZP4 | ZP3 | ZP2 | ZP1 |
| F095 | | | | | | | | |
| F096 | | | | | ZP24 | ZP23 | ZP22 | ZP21 |
| F097 | | | | | | | | |
| F098 | | | | | ZP34 | ZP33 | ZP32 | ZP31 |
| F099 | | | | | | | | |

| | #7 | #6 | #5 | #4 | #3 | #2 | #1 | #0 |
|------|----|----|----|----|--------|--------|--------|--------|
| F100 | | | | | ZP44 | ZP43 | ZP42 | ZP41 |
| F101 | | | | | | | | |
| F102 | | | | | MV4 | MV3 | MV2 | MV1 |
| F103 | | | | | | | | |
| F104 | | | | | INP4 | INP3 | INP2 | INP1 |
| F105 | | | | | | | | |
| F106 | | | | | MVD4 | MVD3 | MVD2 | MVD1 |
| F107 | | | | | | | | |
| F108 | | | | | MMI4 | MMI3 | MMI2 | MMI1 |
| F109 | | | | | | | | |
| F110 | | | | | | | | |
| F111 | | | | | | | | |
| F112 | | | | | EADEN4 | EADEN3 | EADEN2 | EADEN1 |
| F113 | | | | | | | | |
| F114 | | | | | TRQL4 | TRQL3 | TRQL2 | TRQL1 |
| F115 | | | | | | | | |
| F116 | | | | | | | | |
| F117 | | | | | | | | |
| F118 | | | | | | | | |
| F119 | | | | | | | | |
| F120 | | | | | ZRF4 | ZRF3 | ZRF2 | ZRF1 |
| F121 | | | | | | | | |
| F122 | | | | | | | | HDO0 |
| F123 | | | | | | | | |
| F124 | | | | | +OT4 | +OT3 | +OT2 | +OT1 |

| | #7 | #6 | #5 | #4 | #3 | #2 | #1 | #0 |
|------|--------|-------|-------|-------|-------|-------|--------|-------|
| F125 | | | | | | | | |
| F126 | | | | | -OT4 | -OT3 | -OT2 | -OT1 |
| F127 | | | | | | | | |
| F128 | | | | | | | | |
| F129 | *EAXSL | | EOV0 | | | | | |
| F130 | EBSYA | EOTNA | EOTPA | EGENA | EDENA | EIALA | ECKZA | EINPA |
| F131 | | | | | | | EABUFA | EMFA |
| F132 | EM28A | EM24A | EM22A | EM21A | EM18A | EM14A | EM12A | EM11A |
| F133 | EBSYB | EOTNB | EOTPB | EGENB | EDENB | EIALB | ECKZB | EINPB |
| F134 | | | | | | | EABUFB | EMFB |
| F135 | EM28B | EM24B | EM22B | EM21B | EM18B | EM14B | EM12B | EM11B |
| F136 | EBSYC | EOTNC | EOTPC | EGENC | EDENC | EIALC | ECKZC | EINPC |
| F137 | | | | | | | EABUFC | EMFC |
| F138 | EM28C | EM24C | EM22C | EM21C | EM18C | EM14C | EM12C | EM11C |
| F139 | EBSYD | EOTND | EOTPD | EGEND | EDEND | EIALD | ECKZD | EINPD |
| F140 | | | | | | | EABUFD | EMFD |
| F141 | EM28D | EM24D | EM22D | EM21D | EM18D | EM14D | EM12D | EM11D |
| F142 | EM48A | EM44A | EM42A | EM41A | EM38A | EM34A | EM32A | EM31A |
| F143 | | | | | | | | |
| F144 | | | | | | | | |
| F145 | EM48B | EM44B | EM42B | EM41B | EM38B | EM34B | EM32B | EM31B |
| F146 | | | | | | | | |
| F147 | | | | | | | | |
| F148 | EM48C | EM44C | EM42C | EM41C | EM38C | EM34C | EM32C | EM31C |
| F149 | | | | | | | | |

| | #7 | #6 | #5 | #4 | #3 | #2 | #1 | #0 |
|------|-------|-------|-------|-------|-------|-------|-------|-------|
| F150 | | | | | | | | |
| F151 | EM48D | EM44D | EM42D | EM41D | EM38D | EM34D | EM32D | EM31D |
| F152 | | | | | | | | |
| F153 | | | | | | | | |
| F154 | | | | | | | | |
| F155 | | | | | | | | |
| F156 | | | | | | | | |
| F157 | | | | | | | | |
| F158 | | | | | | | | |
| F159 | | | | | | | | |
| F160 | | | | | | | | |
| F161 | | | | | | | | |
| F162 | | | | | | | | |
| F163 | | | | | | | | |
| F164 | | | | | | | | |
| F165 | | | | | | | | |
| F166 | | | | | | | | |
| F167 | | | | | | | | |
| F168 | | | | | | | | |
| F169 | | | | | | | | |
| F170 | | | | | | | | |
| F171 | | | | | | | | |
| F172 | PBATL | PBATZ | | | | | | |
| F173 | | | | | | | | |
| F174 | | | | | | | | |

| | #7 | #6 | #5 | #4 | #3 | #2 | #1 | #0 |
|------|------|-------|------|------|--------|--------|--------|--------|
| F175 | | | | | | | | |
| F176 | | | | | | | | |
| F177 | EDGN | EPARM | EVAR | EPRG | EWTIO | ESTPIO | ERDIO | IOLNK |
| F178 | | | | | SRLNO3 | SRLNO2 | SRLNO1 | SRLNO0 |
| F179 | | | | | | | | |
| F180 | | | | | CLRCH4 | CLRCH3 | CLRCH2 | CLRCH1 |
| F181 | | | | | | | | |
| F182 | | | | | EACNT4 | EACNT3 | EACNT2 | EACNT1 |
| F183 | | | | | | | | |
| F184 | | | | | | | | |
| F185 | | | | | | | | |
| F186 | | | | | | | | |
| F187 | | | | | | | | |
| F188 | | | | | | | | |
| F189 | | | | | | | | |
| F190 | | | | | | | | |
| F191 | | | | | | | | |
| F192 | | | | | | | | |
| F193 | | | | | | | | |
| F194 | | | | | | | | |
| F195 | | | | | | | | |
| F196 | | | | | | | | |
| F197 | | | | | | | | |
| F198 | | | | | | | | |
| F199 | | | | | | | | |

| | #7 | #6 | #5 | #4 | #3 | #2 | #1 | #0 |
|------|----|----|----|----|----|----|----|----|
| F200 | | | | | | | | |
| F201 | | | | | | | | |
| F202 | | | | | | | | |
| F203 | | | | | | | | |
| F204 | | | | | | | | |
| F205 | | | | | | | | |
| F206 | | | | | | | | |
| F207 | | | | | | | | |
| F208 | | | | | | | | |
| F209 | | | | | | | | |
| F210 | | | | | | | | |
| F211 | | | | | | | | |
| F212 | | | | | | | | |
| F213 | | | | | | | | |
| F214 | | | | | | | | |
| F215 | | | | | | | | |
| F216 | | | | | | | | |
| F217 | | | | | | | | |
| F218 | | | | | | | | |
| F219 | | | | | | | | |
| F220 | | | | | | | | |
| F221 | | | | | | | | |
| F222 | | | | | | | | |
| F223 | | | | | | | | |
| F224 | | | | | | | | |

| | #7 | #6 | #5 | #4 | #3 | #2 | #1 | #0 |
|------|----|----|----|----|----|----|----|----|
| F225 | | | | | | | | |
| F226 | | | | | | | | |
| F227 | | | | | | | | |
| F228 | | | | | | | | |
| F229 | | | | | | | | |
| F230 | | | | | | | | |
| F231 | | | | | | | | |
| F232 | | | | | | | | |
| F233 | | | | | | | | |
| F234 | | | | | | | | |
| F235 | | | | | | | | |
| F236 | | | | | | | | |
| F237 | | | | | | | | |
| F238 | | | | | | | | |
| F239 | | | | | | | | |
| F240 | | | | | | | | |
| F241 | | | | | | | | |
| F242 | | | | | | | | |
| F243 | | | | | | | | |
| F244 | | | | | | | | |
| F245 | | | | | | | | |
| F246 | | | | | | | | |
| F247 | | | | | | | | |
| F248 | | | | | | | | |
| F249 | | | | | | | | |

| | #7 | #6 | #5 | #4 | #3 | #2 | #1 | #0 |
|------|----|----|----|----|----|----|----|----|
| F250 | | | | | | | | |
| F251 | | | | | | | | |
| F252 | | | | | | | | |
| F253 | | | | | | | | |
| F254 | | | | | | | | |
| F255 | | | | | | | | |
| F256 | | | | | | | | |
| F257 | | | | | | | | |
| F258 | | | | | | | | |
| F259 | | | | | | | | |
| F260 | | | | | | | | |
| F261 | | | | | | | | |
| F262 | | | | | | | | |
| F263 | | | | | | | | |
| F264 | | | | | | | | |
| F265 | | | | | | | | |
| F266 | | | | | | | | |
| F267 | | | | | | | | |
| F268 | | | | | | | | |
| F269 | | | | | | | | |
| F270 | | | | | | | | |
| F271 | | | | | | | | |
| F272 | | | | | | | | |
| F273 | | | | | | | | |
| F274 | | | | | | | | |

| | #7 | #6 | #5 | #4 | #3 | #2 | #1 | #0 |
|------|----|----|----|----|----|----|----|----|
| F275 | | | | | | | | |
| F276 | | | | | | | | |
| F277 | | | | | | | | |
| F278 | | | | | | | | |
| F279 | | | | | | | | |
| F280 | | | | | | | | |
| F281 | | | | | | | | |
| F282 | | | | | | | | |
| F283 | | | | | | | | |
| F284 | | | | | | | | |
| F285 | | | | | | | | |
| F286 | | | | | | | | |
| F287 | | | | | | | | |
| F288 | | | | | | | | |
| F289 | | | | | | | | |
| F290 | | | | | | | | |
| F291 | | | | | | | | |
| F292 | | | | | | | | |
| F293 | | | | | | | | |
| F294 | | | | | | | | |
| F295 | | | | | | | | |
| F296 | | | | | | | | |
| F297 | | | | | | | | |
| F298 | | | | | | | | |
| F299 | | | | | | | | |

| | #7 | #6 | #5 | #4 | #3 | #2 | #1 | #0 |
|------|----|----|----|----|----|----|----|----|
| F300 | | | | | | | | |
| F301 | | | | | | | | |
| F302 | | | | | | | | |
| F303 | | | | | | | | |
| F304 | | | | | | | | |
| F305 | | | | | | | | |
| F306 | | | | | | | | |
| F307 | | | | | | | | |
| F308 | | | | | | | | |
| F309 | | | | | | | | |
| F310 | | | | | | | | |
| F311 | | | | | | | | |
| F312 | | | | | | | | |
| F313 | | | | | | | | |
| F314 | | | | | | | | |
| F315 | | | | | | | | |

5

FOCAS1/ETHERNET PARAMETER SETTING



On the Ethernet parameter setting screen, set the PCMCIA LAN card parameters required for the SERVO GUIDE and FANUC LADDER-III to operate.

NOTE

Be sure to use the PCMCIA LAN card specified by FANUC.

Display

Procedure

- 1 Place the CNC in the MDI mode.
- 2 Press the function key  .
- 3 Press the continuous menu key at the right end of the soft key display.
- 4 Press the [ETHPRM] soft key. The Ethernet parameter setting screen appears.
- 5 By pressing the [PCMCIA] soft key, the parameters for the PCMCIA LAN card can be set.
- 6 By using the MDI keys and soft keys, enter and update data.
- 7 Switch the screen display with the page keys   .

If data is already registered, the data is displayed.

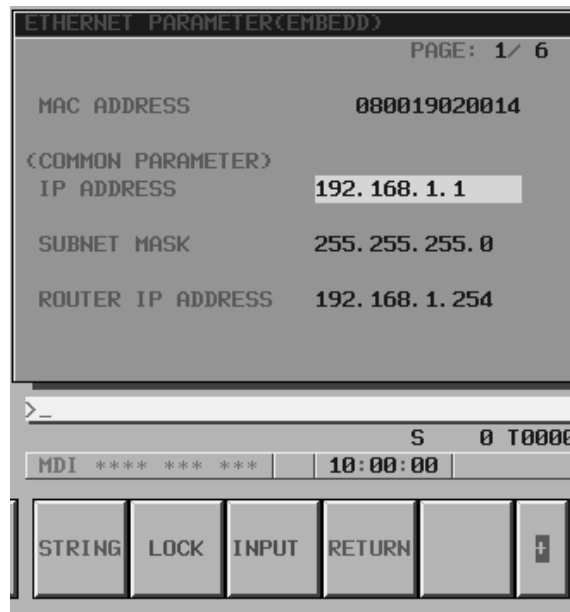

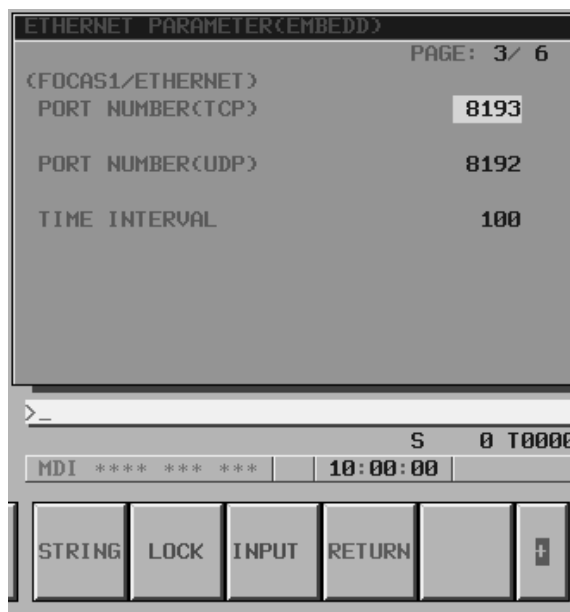

Display item and setting items

Display item

The item related to the PCMCIA LAN card is displayed.

| Item | Description |
|-------------|-----------------------------|
| MAC ADDRESS | PCMCIA LAN card MAC address |

Setting items

Set the TCP/IP-related items of the embedded Ethernet.

| Item | Description |
|-------------------|---|
| IP ADDRESS | Specify the IP address. (Example of specification format: "192.168.1.1") |
| SUBNET MASK | Specify a mask address for the IP addresses of the network. (Example of specification format: "255.255.255.0") |
| ROUTER IP ADDRESS | Specify the IP address of the router. Specify this item when the network contains a router. (Example of specification format: "192.168.1.254") |
| PORT NUMBER (TCP) | Specify a port number. The valid input range is 5001 to 65535. Usually set 8193. |
| PORT NUMBER (UDP) | Specify a UDP port number for transmitting UDP broadcast data. The valid input range is 5001 to 65535. Set 0. |
| TIME INTERVAL | Specify a time interval at which UDP broadcast data specified above with a UDP port number is transmitted. The unit is 10 ms. The valid input range is 10 to 65535. This means that a value less than 100 ms cannot be specified. Set 0. |

6 DIGITAL SERVO



This chapter describes servo tuning screen required for maintenance of digital servo and adjustment of reference position.

| | | |
|-----|--|-----|
| 6.1 | INITIAL SETTING SERVO PARAMETERS | 402 |
| 6.2 | SERVO TUNING SCREEN | 412 |
| 6.3 | ADJUSTING REFERENCE POSITION (DOG METHOD) | 415 |
| 6.4 | DOGLESS REFERENCE POSITION SETTING . . . | 418 |
| 6.5 | α i SERVO WARNING INTERFACE | 420 |
| 6.6 | α i SERVO INFORMATION SCREEN | 422 |

6.1 INITIAL SETTING SERVO PARAMETERS

This section describes how to set initial servo parameters, which is used for field adjustment of machine tool.

1. Turn on power at the emergency stop condition.
2. Set the parameter to display the servo tuning screen.

| | | | | | | | | |
|------|----|----|----|----|----|----|----|-----|
| | #7 | #6 | #5 | #4 | #3 | #2 | #1 | #0 |
| 3111 | | | | | | | | SVS |

- #0 (SVS)** 0 : Servo tuning screen is not displayed.
 1 : Servo tuning screen is displayed.

3. Turn off the power once then turn it on again.
4. Display the servo parameter setting screen by the following operation: SYSTEM key ▶ [SV.PARA].
5. Input data required for initial setting using the cursor and page key.

| SERVO SETTING | | | |
|-----------------------|----------|----------|------------|
| | X-AXIS | Y-AXIS | |
| (1)INITIAL SET BIT | 00000000 | 00000000 | ↔ PRM 2000 |
| (2)MOTOR ID NO. | 47 | 47 | ↔ PRM 2020 |
| (3)amr | 00000000 | 00000000 | ↔ PRM 2001 |
| (4)cmr | 2 | 2 | ↔ PRM 1820 |
| (5)FEED GEAR N | 1 | 1 | ↔ PRM 2084 |
| (6) (N/M) M | 125 | 125 | ↔ PRM 2085 |
| (7)DIRECTION SET | 111 | 111 | ↔ PRM 2022 |
| (8)VELOCITY PULSE NO. | 8192 | 8192 | ↔ PRM 2023 |
| (9)POSITION PULSE NO. | 12500 | 12500 | ↔ PRM 2024 |
| (10)REF. COUNTER | 8000 | 8000 | ↔ PRM 1821 |

(1)Initial set bit

| | | | | | | | | |
|------|----|----|----|----|--------|----|-------|-------|
| | #7 | #6 | #5 | #4 | #3 | #2 | #1 | #0 |
| 2000 | | | | | PRMCAL | | DGPRM | PLC01 |

- #3 (PRMCAL)** 1 : Turns to 1 when the initial setting is done.
 The following parameters are set automatically in accordance with the no. of pulses of pulse coder:
 PRM 2043(PK1V), PRM 2044(PK2V), PRM 2047(POA1),
 PRM 2053(PPMAX),PRM 2054(PDDP),
 PRM 2056(EMFCMP),
 PRM 2057(PVPA), PRM 2059(EMFBAS),
 PRM 2074(AALPH),PRM 2076(WKAC)
- #1 (DGPRM)☆** 0 : Initial setting of digital servo parameter is done.
 1 : Initial setting of digital servo parameter is not done.
- #0 (PLC01)** 0 : Values of parameter 2023 and 2024 are used as they are:
 1 : Values of parameter 2023 and 2024 are multiplied by 10.

(2) Motor ID No.

Select the motor ID No. of the servo motor to be used, according to the motor model and drawing number (the middle four digits of A06B-XXXX-BXXX).

For the motor ID No. of the servo motor, refer to the parameter manual for servo motors.

NOTE

Servo axes are controlled in groups of two axes. So, for successive servo control numbers (odd number and even number), motor type number unified for servo HRV1 or for servo HRV2 or HRV3 must be specified.

(3) Arbitrary AMR function

| | | | | | | | | | | |
|-----|------|------|------|------|------|------|------|------|------|---------------|
| | | #7 | #6 | #5 | #4 | #3 | #2 | #1 | #0 | |
| PRM | 2001 | AMR7 | AMR6 | AMR5 | AMR4 | AMR4 | AMR3 | AMR2 | AMR1 | For each axis |

NOTE

Set "00000000".

(4) CMR

| | | |
|-----|------|------------------------|
| PRM | 1820 | Command multiply ratio |
|-----|------|------------------------|

- 1) When CMR is 1/2 to 1/27 Set value = $\frac{1}{\text{CMR}} + 100$
- 2) When CMR is 0.5 to 48 Set value = $2 \times \text{CMR}$

(5) Turn off the power then back on.

(6) N/M of feed gear (F·FG)

| | | |
|-----|------|--------------------------|
| PRM | 2084 | n for flexible feed gear |
| PRM | 2085 | m for flexible feed gear |

Setting for the α pulse coder in the semi-closed mode

$$\frac{\text{(Note 1) F.FG numerator (} \leq 32767 \text{)}}{\text{F.FG denominator (} \leq 32767 \text{)}} = \frac{\text{Necessary position feedback pulses per motor revolution}}{1,000,000 \text{ (Note 2)}} \text{ (as irreducible fraction)}$$

NOTE

- 1 For both F-FG number and denominator, the maximum setting value (after reduced) is 32767.
- 2 α_i pulse coders assume one million pulses per motor revolution, irrespective of resolution, for the flexible feed gear setting.
- 3 If the calculation of the number of pulses required per motor revolution involves π , such as when a rack and pinion are used, assume π to be approximately 355/113.

[Example]

For detection in 1 μm units, specify as follows:

| Ball screw lead (mm/rev) | Number of necessary position pulses (pulses/rev) | F·FG |
|--------------------------|--|---------------|
| 10 | 10000 | 1/100 |
| 20 | 20000 | 2/100 or 1/50 |
| 30 | 30000 | 3/100 |

[Example]

If the machine is set to detection in 1,000 degree units with a gear reduction ratio of 10:1 for the rotation axis, the table rotates by 360/10 degrees each time the motor makes one turn.

1000 position pulses are necessary for the table to rotate through one degree.

The number of position pulses necessary for the motor to make one turn is:

$$360/10 \times 1000 = 36000 \text{ with reference counter} = 36000$$

$$\frac{\text{F·FG numerator}}{\text{F·FG denominator}} = \frac{36000}{1,000,000} = \frac{36}{1000}$$

| Setting for use of a separate detector (full-closed) | | |
|--|---|---|
| F·FG numerator (≤ 32767) | = | Number of position pulses corresponding to a predetermined amount of travel (as irreducible fraction) |
| F·FG denominator (≤ 32767) | = | Number of position pulses corresponding to a predetermined amount of travel from a separate detector |

[Example]

To detect a distance of 1-μm using a 0.5-μm scale, set the following:

$$\frac{\text{Numerator of F·FG}}{\text{Denominator of F·FG}} = \frac{L/1}{L/0.5} = \frac{1}{2}$$

<<Examples of calculation>>

| | 1/1000 mm | 1/10000 mm |
|-------------------------|-----------|------------|
| One revolution of motor | n=1/m=125 | n=2/m=25 |
| 8mm | n=1/m=100 | n=1/m=10 |
| 10mm | n=3/m=250 | n=3/m=25 |
| 12mm | | |

(7) Direction of travel

PRM

2022

Rotational direction of motor

111 : Normal (clockwise) -111 : Reverse (counterclockwise)

(8) Number of velocity pulses and position pulses

1) For serial αi pulse coder, or serial α pulse coder

| | Paramter No. | Increment system : 1/1000mm | | Increment system : 1/10000mm | |
|---------------------------------|--------------|-----------------------------|------------------|------------------------------|------------------|
| | | Closed loop | Semi-closed loop | Closed loop | Semi-closed loop |
| High resolution setting | 2000 | xxxx xxx 0 | | xxxx xxx 1 | |
| Separate detector | 1815 | 00100010 | 0010 0000 | 00100010 | 0010 0000 |
| No. of velocity feedback pulses | 2023 | 8192 | | 819 | |
| No. of position feedback pulses | 2024 | NS | 12500 | NS/10 | 1250 |

NOTE

- 1 NS is the number of position feedback pulses per one revolution of the motor (multiplied by four)
- 2 Even if the system employs a closed loop, bit 3 of parameter 2002 is 1 and bit 4 is 0.

(9) Reference counter

PRM

1821

Reference counter capacity for each axis (0 – 99999999)

6. Turn off the power then back on.



(10) FSSB display and setting screen

Connecting the CNC control unit to servo amplifiers via a high-speed serial bus (FANUC Serial Servo Bus, or FSSB), which uses only one fiber optics cable, can significantly reduce the amount of cabling in machine tool electrical sections.

Axis settings are calculated automatically according to the interrelationships between axes and amplifiers entered on the FSSB setting screen. Parameter Nos. 1023, 1905, 1910 to 1919, 1936, and 1937 are specified automatically according to the results of the calculation.

- Display

The FSSB setting screen displays FSSB-based amplifier and axis information. This information can also be specified by the operator.

1. Press function key  .
2. To display [FSSB], press continuous menu key  several times.
3. Pressing soft key [FSSB] causes the AMP SET screen (or the previously selected FSSB setting screen) to appear, with the following soft keys displayed.



The FSSB setting screens include: AMP SET, AXIS SET, and AMP MAINTENANCE.

Pressing soft key [AMP] causes the AMP SET screen to appear.

Pressing soft key [AXIS] causes the AXIS SET screen to appear.

Pressing soft key [MAINTE] causes the AMP MAINTENANCE screen to appear.

1) Amplifier setting screen

The amplifier setting screen consists of two sections: the first section displays information about the slave, while the second section displays information about the pulse modules.

| AMPLIFIER SETTING | | | | | O1000 N00001 | |
|---|-------|----------|-----------------------|------|--------------|------|
| NO. | AMP | SERIES | UNIT | CUR. | AXIS | NAME |
| 1 | A1-L | α | SVM-HV | 40AL | 1 | X |
| 2 | A1-M | α | SVM | 12A | 2 | Y |
| 3 | A2-L | β | SVM | 40A | 3 | Z |
| 4 | A3-L | α | SVM | 20A | 4 | A |
| | | | | | | |
| NO. | EXTRA | TYPE | PCB ID | | | |
| 5 | M1 | A | 0000 DETECTOR (8AXES) | | | |
| 6 | M2 | B | 12AB | | | |
| >_ | | | | | | |
| MDI **** * * * * | | | 13:11:56 | | | |
| [AMP] [AXIS] [MAINT] [] [(OPRT)] | | | | | | |

The amplifier setting screen consists of the following items:

- NO. (slave number)

The numbers of up to ten slaves (up to eight amplifiers and up to two pulse modules) connected via the FSSB are displayed sequentially, with the one nearest to the CNC being number 1.
- AMP (amplifier type)

The amplifier type display consists of the letter A, which stands for “amplifier,” a number that indicates the placing of the amplifier, as counted from that nearest to the CNC, and a letter such as L (first axis) or M (second axis) indicating the placing of the axis in the amplifier.
- AXIS NO. (controlled axis number)

The axis number of each controlled axis specified in parameters (Nos. 1920 to 1929) is displayed. If a number specified in these parameters falls outside the range of between 1 and the maximum number of controlled axes, 0 is displayed.
- NAME (controlled axis name)

The axis name assigned to a parameter (No. 1020) corresponding to a particular controlled axis number is displayed. If the controlled axis number is 0, – is displayed.
- The following items are displayed as amplifier information:
 - UNIT (servo amplifier unit type)
 - SERIES (servo amplifier name)
 - CURRENT (maximum rating)
- The following items are displayed as pulse module information:
 - SEPARATE

This display consists of the letter M, which stands for “pulse module” and a number indicating the placing of the pulse module, as counted from that nearest to the CNC.
 - TYPE

This display is a letter indicating the type of the pulse module.

· PCB ID

This display consists of four digits indicating the pulse module ID (hexadecimal). The pulse module ID is followed by DETECTOR (8-AXES) for the eight-axis separate detector module or DETECTOR (4-AXES) for the four-axis separate detector module.

2) Axis setting screen

The axis setting screen displays the information shown below:



| AXIS SETTING | | | | O1000 N00001 | | | |
|--------------|------|------|----|--------------|-------|----|------|
| AXIS | NAME | AMP | M1 | M2 | 1-DSF | Cs | TNDM |
| 1 | X | A1-L | 0 | 0 | 0 | 0 | 0 |
| 2 | Y | A1-M | 1 | 0 | 1 | 0 | 0 |
| 3 | Z | A2-L | 0 | 0 | 0 | 1 | 0 |
| 4 | A | A3-L | 0 | 0 | 0 | 0 | 0 |

>
 MDI **** *
 [AMP] [AXIS] [MAINT] [] [(OPRT)]

This axis setting screen displays the following items:

- **AXIS** (controlled axis number)
This item is the placing of the NC controlled axis.
- **NAME** (controlled axis name)
- **AMP** (type of the amplifier connected to each axis)
- **M1** (connector number for pulse module 1)
This item is the number of the connector for pulse module 1, specified in parameter No. 1931.
- **M2** (connector number for pulse module 2)
This item is the number of the connector for pulse module 2, specified in parameter No. 1932.
- **1-DSF**
This item is the value specified in bit 0 (parameter 1 DSP) of parameter No. 1904. It is 1 for an axis (such as a high-speed current loop axis, or high-speed interface axis) that exclusively uses a DSP, which is usually shared by two-axes.
- **Cs**: Cs contour controlled axis
This item is the value specified in parameter No. 1933. It is 1 for the Cs contour controlled axis.

3) Amplifier maintenance screen

The amplifier maintenance screen displays maintenance information for servo amplifiers. This screen consists of the following two pages, either of which can be selected by pressing the  or  key.

| AMPLIFIER MAINTENANCE | | | | | | O1000 N00001 | |
|-----------------------|------|------|----------|--------|------|--------------|--|
| AXIS | NAME | AMP | SERIES | UNIT | AXES | CUR. | |
| 1 | X | A1-L | α | SVM-HV | 2 | 40AL | |
| 2 | Y | A1-M | α | SVM | 2 | 12A | |
| 3 | Z | A2-L | β | SVM | 1 | 40A | |
| 4 | A | A3-L | α | SVM | 1 | 20A | |

MDI **** * * * * * 13:11:56
[AMP] [AXIS] [MAINT] [] []

| AMPLIFIER MAINTENANCE | | | | | O1000 N00001 | |
|-----------------------|------|---------|--------|-----------|--------------|--|
| AXIS | NAME | EDITION | TEST | MAINT-NO. | | |
| 1 | X | 01A | 020123 | 01 | | |
| 2 | Y | 01A | 020123 | 01 | | |
| 3 | Z | 01A | 020123 | 01 | | |
| 4 | A | 02B | 020123 | 01 | | |

MDI **** * * * * * 13:11:56
[AMP] [AXIS] [MAINT] [] []

The amplifier maintenance screen displays the following items:

- AXIS (controlled axis number)
- NAME (controlled axis name)
- AMP (type of amplifier connected to each axis)
- SERIES (servo amplifier series of an amplifier connected to each axis)
- UNIT (unit type of a servo amplifier connected to each axis)
- AXES (maximum number of axes controlled by an amplifier connected to each axis)
- CUR. (maximum rating for amplifiers connected to each axis)
- EDITION (unit version number of an amplifier connected to each axis)
- TEST (date of test performed on an amplifier connected to each axis)
Example) 010123 = January 23, 2001
- MAINT-NO. (engineering change number for an amplifier connected to each axis)

● **Setting**

On an FSSB setting screen (other than the amplifier maintenance screen), pressing soft key [(OPRT)] displays the following soft keys:



To enter data, place the machine in MDI mode or the emergency stop state, position the cursor to the point where a desired item is to be input, then enter the desired data and press soft key **[INPUT]** (or the key on the MDI panel).

When soft key **[SET]** is pressed after data has been entered, a warning message is displayed if the entered data contains an error. When the data is satisfactory, the corresponding parameter is set up.

To restore the previous value of a parameter if, for example, an entered value is incorrect, press soft key **[READ]**.

When the power is turned on, values are read from the parameters and displayed on the screen.

CAUTION

- 1 For the parameters to be specified on the FSSB setting screen, do not attempt to enter values on the parameter screen using the MDI or a G10 command. Use only the FSSB screen to enter values for these parameters.
- 2 If pressing soft key **[SET]** results in a warning message being displayed, retry data entry, or press soft key **[READ]** to clear the warning message. Note that pressing the reset key does not clear the warning message.

1) Amplifier setting screen

| AMPLIFIER SETTING | | | | O1000 N00001 | | |
|-------------------|-------|--------|--------|--------------------------|-----------|---|
| NO. | AMP | SERIES | UNIT | CUR. | AXIS NAME | |
| 1 | A1-L | α | SVM-HV | 40AL | 1 | X |
| 2 | A1-M | α | SVM | 12A | 2 | Y |
| 3 | A2-L | β | SVM | 40A | 3 | Z |
| 4 | A3-L | α | SVM | 20A | 4 | A |
| | | | | | | |
| NO. | EXTRA | TYPE | PCB ID | | | |
| 5 | M1 | A | 0000 | DETECTOR (8AXES) | | |
| 6 | M2 | B | 12AB | | | |
| | | | | | | |
| >_ | | | | MDI **** * 13:11:56 | | |
| [SETTING] [| | | |] [READ] [] [INPUT] | | |

The amplifier setting screen displays the following items:

- NO. (controlled axis number)

For this item, enter a value of between 1 and the maximum number of controlled axes. If a number that falls outside this range is entered, the warning message “**INVALID FORMAT**” appears. If the entered controlled axis number is duplicate or 0, the warning message “**SPECIFIED DATA IS OUT OF RANGE**” appears when soft key [SET] is pressed to assert the entered value. In this case, no value can be entered for the parameter.

2) Axis setting screen

| AXIS SETTING | | | | O1000 N00001 | | | |
|--------------|------|------|----|--------------|-------|----|------|
| AXIS | NAME | AMP | M1 | M2 | 1-DSF | Cs | TNDM |
| 1 | X | A1-L | 0 | 0 | 0 | 0 | 0 |
| 2 | Y | A1-M | 1 | 0 | 1 | 0 | 0 |
| 3 | Z | A2-L | 0 | 0 | 0 | 1 | 0 |
| 4 | A | A3-L | 0 | 0 | 0 | 0 | 0 |

>
 MDI **** * * * * 13:11:56
 [SETTING] [] [READ] [] [INPUT]

On the axis setting screen, the following items can be specified:

- M1 (connector number for pulse module 1)

For an axis that uses pulse module 1, enter a connector number using a number in the range of between 1 and the maximum number of axes for pulse module 1. When pulse module 1 need not be used, enter 0. If a number that falls outside the valid range is entered, the warning message “**INVALID FORMAT**” is displayed.

- M2 (connector number for pulse module 2)

For an axis that uses pulse module 2, enter a connector number using a number in the range of between 1 and the maximum number of axes for pulse module 2. When pulse module 2 need not be used, enter 0. If a number that falls outside the valid range is entered, the warning message “**INVALID FORMAT**” is displayed.

- 1-DSF

Enter 1 for the following axes, each of which exclusively uses a DSP, which is usually shared by two-axes. If a number other than 0 or 1 is entered, the warning message “**INVALID FORMAT**” is displayed.

- Learning control axis
- High-speed current loop axis
- High-speed interface axis

- Cs (Cs contour controlled axis)

Enter 1 for the Cs contour controlled axis. If a number other than 0 or 1 is entered, the warning message “**INVALID FORMAT**” is displayed.

When soft key **[SET]** is pressed on the axis setting screen after data entry, the warning message **“SPECIFIED DATA IS OUT OF RANGE”** is displayed if any of the following conditions is satisfied.

- Both M1 and M2 are nonzero for an axis.
- Any two of TWO-AXES, Cs, and TANDEM are nonzero for an axis.
- A duplicate value is specified for M1.
- A duplicate value is specified for M2.
- A duplicate value is specified for Cs.
- A duplicate value is specified for TANDEM.
- An invalid master/slave axis pair is specified for TANDEM.

6.2 SERVO TUNING SCREEN



6.2.1 Parameter Setting

Set a parameter to display the servo tuning screen.

| | | | | | | | | |
|------|----|----|----|----|----|----|----|-----|
| | #7 | #6 | #5 | #4 | #3 | #2 | #1 | #0 |
| 3111 | | | | | | | | SVS |

- #0 (SVS)** 0 : Servo tuning screen is not displayed.
 1 : Servo tuning screen is displayed.

6.2.2 Displaying Servo Tuning Screen

1. Press  key  and soft key [SV. PARA] in this order.
2. Press soft key [SV.TUN] to select the servo tuning screen.

| | | | | |
|--|--------------|-----------|-----------|---------------|
| SERVO TUNING | | 01234 | N12345 | |
| (PARAMETER) | | (MONITOR) | | |
| (1) | FUN.BIT | 00000000 | ALARM 1 | 00000000 (9) |
| (2) | LOOP GAIN | 3000 | ALARM 2 | 00000000 (10) |
| (3) | TURNING SET. | 0 | ALARM 3 | 10000000 (11) |
| (4) | SET PERIOD | 0 | ALARM 4 | 00000000 (12) |
| (5) | INT.GAIN | 113 | ALARM 5 | 00000000 (13) |
| (6) | PROP.GAIN | -1015 | LOOP GAIN | 2999 (14) |
| (7) | FILER | 0 | POS ERROR | 556 (15) |
| (8) | VELOC.GAIN | 125 | CURRENT% | 10 (16) |
| | | | SPEED RPM | 100 (17) |
| <div style="display: flex; justify-content: space-around; margin-top: 10px;"> { SV SET } { SV TUN } { } { } { OPE } </div> | | | | |

- (1) Function bit : PRM 2003
- (2) Loop gain : PRM 1825
- (3) Tuning start :
- (4) Set period :
- (5) Integral gain : PRM 2043
- (6) Proportional gain : PRM 2044
- (7) Filter : PRM 2067
- (8) Velocity gain Set value= $\frac{(\text{PRM } 2021)+256}{256} \times 100$
- (9) Alarm 1 : DGN 200 (Details of alarm 400 and 414)
- (10) Alarm 2 : DGN 201 (Details of disconnection alarm, overload)
- (11) Alarm 3 : DGN 202 (Details of alarm 319)
- (12) Alarm 4 : DGN 203 (Details of alarm 319)
- (13) Alarm 5 : DGN 204 (Details of alarm 414)
- (14) Loop gain : Actual loop gain
- (15) Position error : Actual position error(DGN 300)
- (16) Current(%) : Indicate current with % to the rated value.
- (17) Current(A) : Indicate current with A.
- (18) Speed RPM : Number of motor actual rotation

| | #7 | #6 | #5 | #4 | #3 | #2 | #1 | #0 |
|--------|-----|----|-----|-----|-----|-----|-----|-----|
| Alarm1 | OVL | LV | OVC | HCA | HVA | DCA | FBA | OFA |

DGN (200) :

#7 (OVL) : Overload alarm

#6 (LV) : Insufficient voltage alarm

#5 (OVC) : Overcurrent alarm

#4 (HCA) : Abnormal current alarm

#3 (HVA) : Excessive voltage alarm

#2 (DCA) : Discharge alarm

#1 (FBA) : Disconnection alarm

#0 (OFA) : Overflow alarm

| | #7 | #6 | #5 | #4 | #3 | #2 | #1 | #0 |
|--------|-----|----|----|-----|----|----|----|----|
| Alarm2 | ALD | | | EXP | | | | |

DGN (201) ↓

| | | | | | |
|---------------------|---|---|---|---|--|
| Over-load alarm | 0 | — | — | — | Amplifieroverheat |
| | 1 | — | — | — | Motoroverheat |
| Disconnection alarm | 1 | — | — | 1 | Separate type pulse coder disconnection (Hardware) |
| | 0 | — | — | 0 | Pulse coder disconnection (software) |

| | #7 | #6 | #5 | #4 | #3 | #2 | #1 | #0 |
|--------|----|-----|-----|-----|-----|-----|-----|-----|
| Alarm3 | | CSA | BLA | PHA | RCA | BZA | CKA | SPH |

DGN (202) :

#6 (CSA) : Hardware of serial pulse coder is abnormal.

#5 (BLA) : Battery voltage is in low (warning).

#4 (PHA) : Serial pulse coder or feedback cable is abnormal.
Counting the feedback signal is in error.

#3 (RCA) : Serial pulse coder is faulty.
Counting is in error.

If the RCA bit is set to 1 when both the FBA bit (bit 1 of alarm 1) and ALD bit of alarm 2 are set to 1 and the EXP bit of alarm 2 (internal hardware disconnection) is set to 1, a count miss alarm (CMAL) occurs in the α pulse coder.

#2 (BZA) : Battery voltage becomes 0.
Replace batteries and set the reference position.

#1 (CKA) : Serial pulse coder is faulty.
Internal clock has stopped.

#0 (SPH) : Serial pulse coder or feedback cable is faulty.
Counting the feedback signal is in error.

| | #7 | #6 | #5 | #4 | #3 | #2 | #1 | #0 |
|--------|-----|-----|-----|-----|----|----|----|----|
| Alarm4 | DTE | CRC | STB | PRM | | | | |

DGN (203) :

- #7 (DTE) :** Communication error of serial pulse coder.
There is no response.
Generally, a leading cause is a break in a wire.
- #6 (CRC) :** Communication error of serial pulse coder.
Transmitted data is in error.
- #5 (STB) :** Communication error of serial pulse coder.
Transmitted data is in error.
- #4 (PRM) :** The alarm is detected by the digital servo, the values specified in the parameter is not correct.

| | #7 | #6 | #5 | #4 | #3 | #2 | #1 | #0 |
|--------|----|-----|-----|-----|-----|----|----|----|
| Alarm5 | | OFS | MCC | LDM | PMS | | | |

DGN (204) :

- #6 (OFS) :** A/D conversion of current value of digital servo is abnormal.
- #5 (MCC) :** Contacts of electro-magnetic contactor of servo amplifier is blown
- #4 (LDM) :** LED of α pulse coder is abnormal.
- #3 (PMS) :** No. of feedback pulses are in error because α pulse coder or feedback cable is faulty.

6.3 ADJUSTING REFERENCE POSITION (DOG METHOD)

6.3.1 General

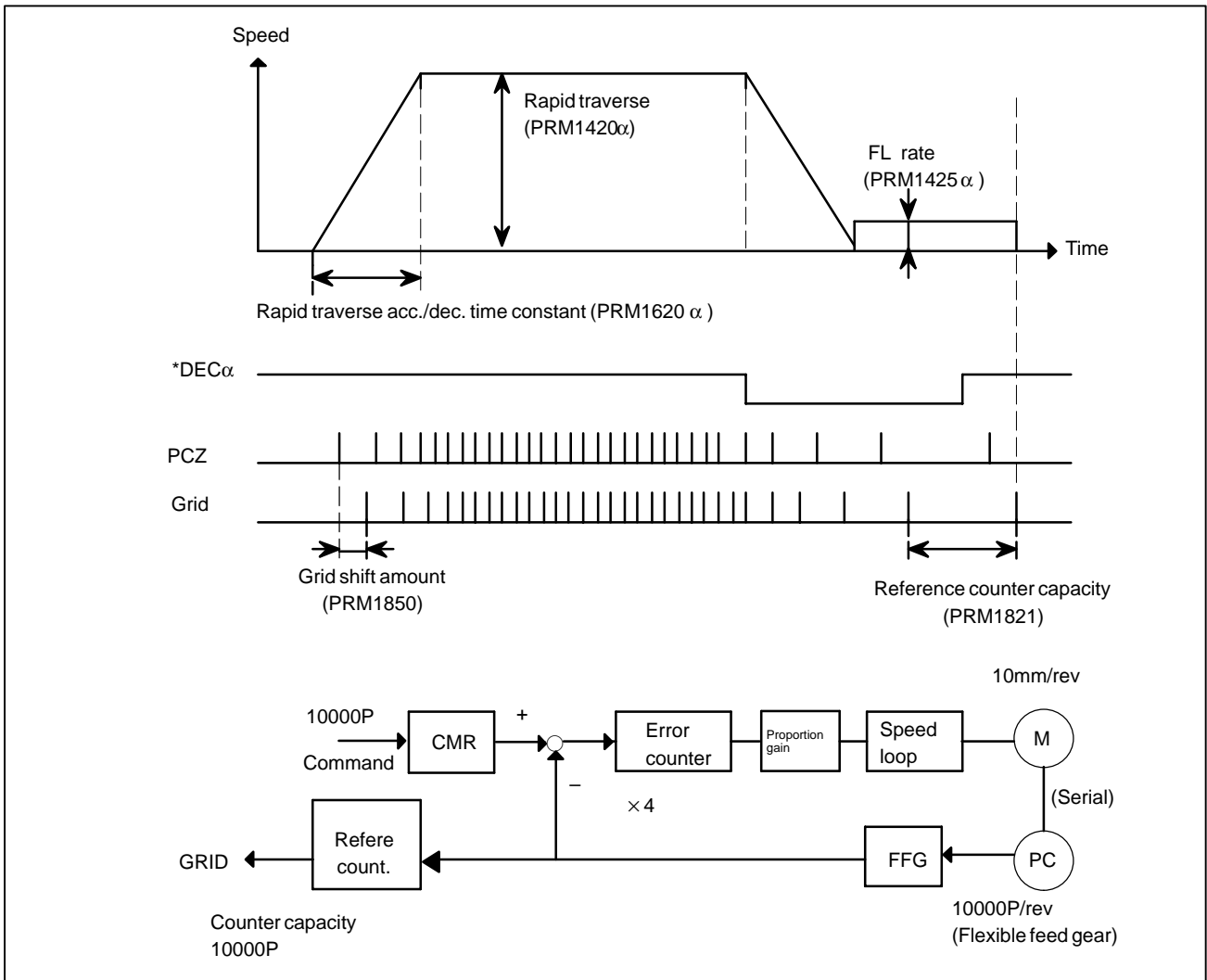

● **Parameter**

| | | | | | | | | |
|-----|------|----|----|----|----|----|-----|----|
| | #7 | #6 | #5 | #4 | #3 | #2 | #1 | #0 |
| PRM | 1002 | | | | | | DLZ | |

#1(DLZ) 0 : Reference position return method is normal (dog).

1 : Dogless reference position setting is used.

| | | | | | | | | | |
|-----|------|----|----|----|----|----|----|-----|----|
| | | #7 | #6 | #5 | #4 | #3 | #2 | #1 | #0 |
| PRM | 1005 | | | | | | | DLZ | |

- #1(DLZ)** 0 : The normal method (dog) is used for reference position return.
 1 : Reference position setting without dogs is used (axis by axis).

NOTE

A reference position can be set axis by axis by setting bit 1 of parameter No. 1002 to 0 and setting bit 1 of parameter No. 1005. Reference position setting without dogs cannot be used for a spindle positioning axis and Cs contour axis. When these axes are involved, use bit 1 of parameter No. 1005.

| | | |
|-----|------|--------------------------------|
| PRM | 1821 | Reference counter capacity [P] |
|-----|------|--------------------------------|

No. of feedback pulses or its division by an integer is set.

| | | |
|-----|------|--------------------------------|
| PRM | 1850 | Grid shift amount per axis [P] |
|-----|------|--------------------------------|

When the resolution is 0.0001mm, set the value in the unit ten times the detection unit.

| | | | | | | | | | |
|-----|------|----|----|-----|-----|----|----|-----|----|
| | | #7 | #6 | #5 | #4 | #3 | #2 | #1 | #0 |
| PRM | 1815 | | | APC | APZ | | | OPT | |

- #5(APC)** 0 : Position detector is other than absolute pulse coder.
 1 : Position detector is absolute pulse coder.

#4(APZ) Zero position of absolute pulse coder is :

0 : Not established

1 : Established

(Turns to 1 after establishment)

To manually change the value of the APZ bit from 0 to 1 without first returning to the reference position

when using serial pulse coder α , follow this procedure: Back up the data with the battery and give the motor one or more turns.

Turn the power off then on again, then change the APZ bit setting from 0 to 1.

- #1(OPT)** 0 : Position detection is performed by the pulse coder built in the motor.
 1 : Separate type pulse coder or linear scale is used.

● **Separate Type Pulse Coder or Linear Scale is Used**

PRM 1821 Reference counter capacity per axis [P]

Normally, the number of feedback pulses per motor revolution is set to the reference counter capacity.

When plural reference marks are on a linear scale, a quotient of the distance between the reference marks divided by an interfer may be used as a reference counter capacity:

Example)

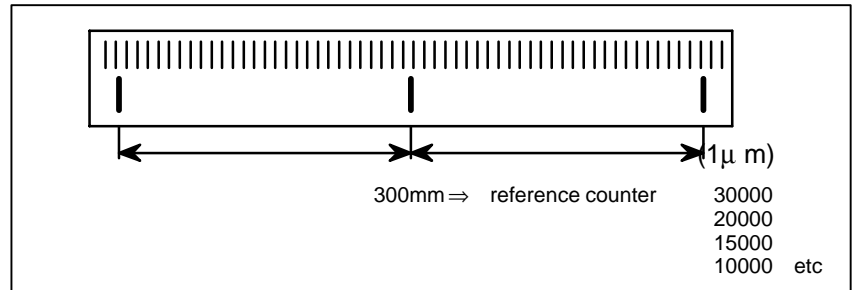

6.4 DOGLESS REFERENCE POSITION SETTING

When there are no dog nor limit switch for reference position return, this function enables the tool to return the reference position that is set by MTB.

When the absolute position detector is used, the reference position once set remains also during power off. When the absolute detector is replaced or absolute position is lost, perform this setting.

6.4.1 General

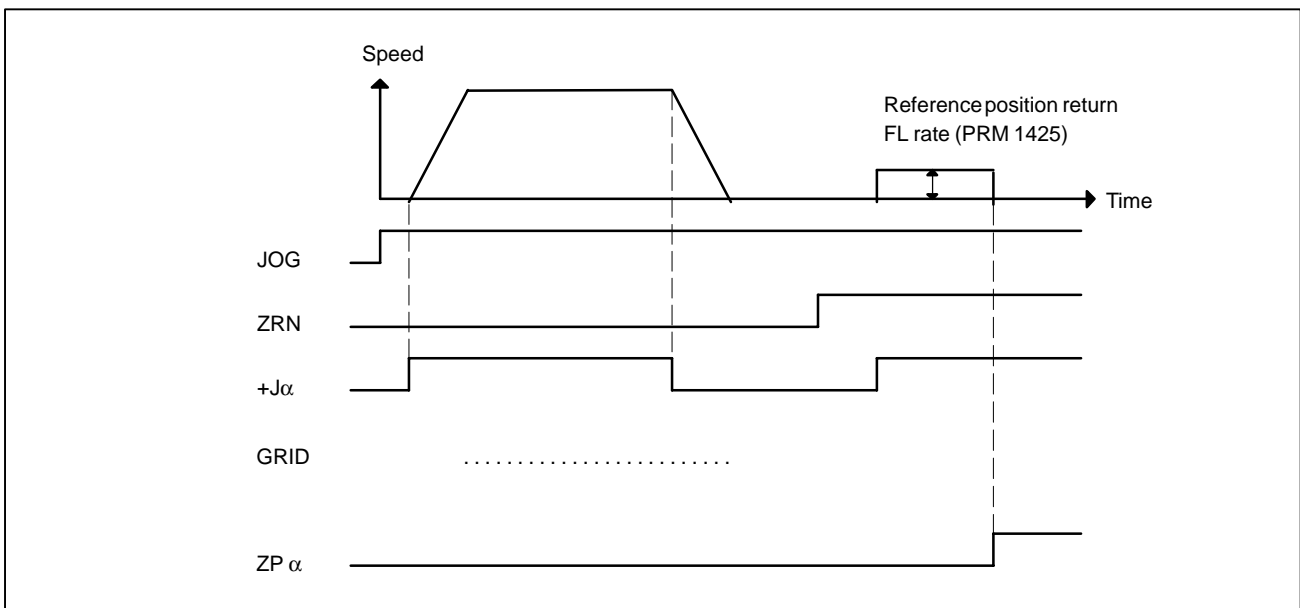

6.4.2 Operation

- 1 Move the tool near the reference position using a manual operation.
 - 2 Select the reference position return mode or switch.
 - 3 Press a button for an axis-and-direction-select-signal + or -, and the machine moves to the next grid, then stops.
(This position is set as the reference position).
- ✳ After the reference position has been set, select the reference position return mode (ZRN signal is 1) and turn on an axis-and-direction-select signal, then the tool returns to the reference position.

6.4.3 Associated Parameters

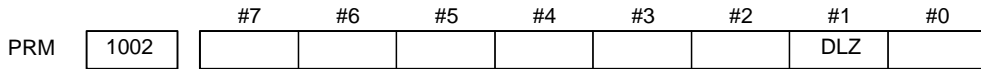

#1(DLZ) 0 : Dog is used for reference position return
 1 : Dogless reference position setting (all axes)

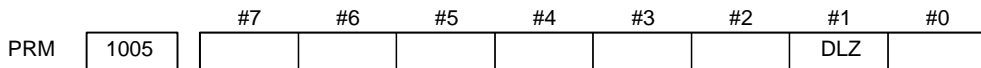

#1(DLZ) 0 : The normal method (dog) is used for reference position return.
 1 : Reference position setting without dogs is used (axis by axis).

NOTE
 A reference position can be set axis by axis by setting bit 1 of parameter No. 1002 to 0 and setting bit 1 of parameter No. 1005. Reference position setting without dogs cannot be used for a spindle positioning axis and Cs contour axis. When these axes are involved, use bit 1 of parameter No. 1005.

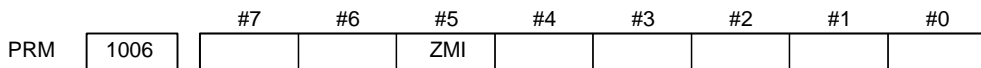

#5(ZMI) 0 : Reference position return and backlash initial direction is +.
 1 : Reference position return and backlash initial direction is -.

✳ After ZRN signal becomes 1, manual feed direction is always the direction set by this parameter irrespective of an axis selection signal.

6.5 *α*i SERVO WARNING INTERFACE

General

The *α*i servo system can report the warning status before one of the following target alarms occurs.

When the warning status is entered, a report to the PMC is issued.

For example, this signal can be used by the machine for retracting tools from the time a warning occurs by the time a servo alarm occurs.

Signal

Servo warning detail signals SVWRN1 to 4 <F093#4 to #7>

[Classification] Output signal

[Function] Reports the warning signal corresponding to the state of the servo amplifier.

[Output condition] The following table shows the warning statuses of the servo amplifier and their corresponding warning signals.

| Corresponding alarm messages | Warning status signals (F93) | | | | Time from when a warning state signal is issued to until an alarm occurs |
|---------------------------------------|------------------------------|-------------|-------------|-------------|--|
| | SVWRN4 (#7) | SVWRN3 (#6) | SVWRN2 (#5) | SVWRN1 (#4) | |
| 444 n AXIS: INV. COOLING FAN FAILURE | 1 | 0 | 0 | 0 | One minute |
| 601 n AXIS: INV. RADIATOR FAN FAILURE | 1 | 0 | 0 | 1 | Until overheat occurs (inconstant) |
| 443 n AXIS: CNV. COOLING FAN FAILURE | 1 | 1 | 0 | 0 | One minute |
| 606 n AXIS: CNV. RADIATOR FAN FAILURE | 1 | 1 | 0 | 1 | Until overheat occurs (inconstant) |
| 431 n AXIS: CNV. OVERLOAD | 1 | 1 | 1 | 0 | One minute |
| 607 n AXIS: CNV. SINGLE PHASE FAILURE | 1 | 1 | 1 | 1 | PSMR: Five seconds, PSM: One minute |

A timing chart for handling a warning is shown below.

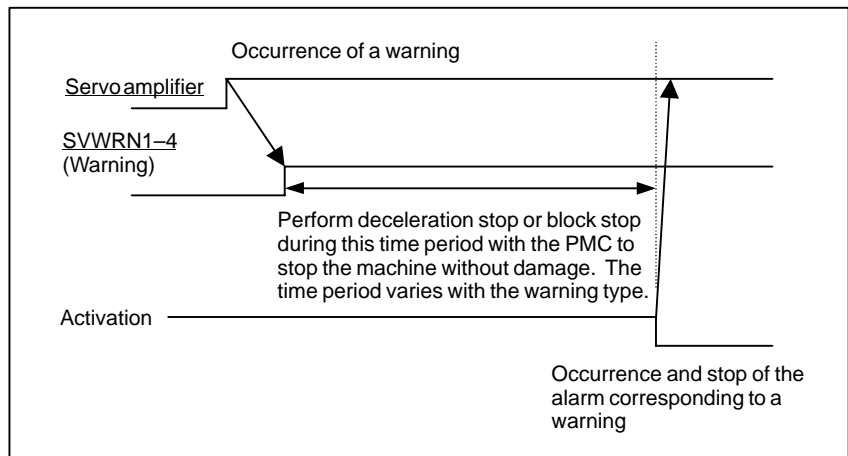

Signal address

| | | | | | | | | |
|------|--------|--------|--------|--------|----|----|----|----|
| | #7 | #6 | #5 | #4 | #3 | #2 | #1 | #0 |
| F093 | SVWRN4 | SVWRN3 | SVWRN2 | SVWRN1 | | | | |

Alarms with the αi servo amplifier in the warning state

If SWP parameter (bit 2 of parameter No. 1807) = 0, a servo alarm, in addition to a warning signal, is issued when the αi servo amplifier gets in the warning state.

The servo alarms listed below place automatic operation on feed hold, thus decelerating all controlled axes (including the PMC axis) until they stop.

These alarms will not de-energize the servo motors.

| Alarm No. with the servo amplifier in the warning state | Alarm No. with the servo amplifier in the alarm state | Alarm message |
|---|---|---|
| 608 | 444 | n axis : The inverter's internal cooling fan stopped. |
| 609 | 601 | n axis : The inverter radiator cooling fan stopped. |
| 610 | 443 | n axis : The converter cooling fan stopped. |
| 611 | 606 | n axis : The converter radiator cooling fan stopped. |
| 612 | 431 | n axis : The converter main circuit was overloaded. |
| 613 | 607 | n axis : The converter main power supply encountered an open-phase condition. |

If the αi servo amplifier actually gets in the alarm state after any of the above servo alarms with the servo amplifier in the warning state has occurred, the servo motors are de-energized, resulting in an alarm with the servo amplifier in the alarm state being displayed.

If SWP (bit 2 of parameter No. 1807) = 1, a warning signal, rather than an alarm with the servo amplifier in the warning state, is issued when the αi servo amplifier gets in the warning state. If the servo amplifier gets in the warning state during automatic operation, the automatic operation continues. In this case, decelerate each axis until they stop, using the warning state signal before the servo motors are de-energized. Otherwise, the motors may get de-energized in the middle of axis movement.

6.6

α i SERVO INFORMATION SCREEN

General

In the α i servo system, ID information output from each of the connected units is obtained and output to the CNC screen.

The units that have ID information are shown below.

(Remark: Some instances of these units do not have ID information.)

- Servo motor
- Pulse coder
- Servo amplifier module
- Power supply module

ID information is automatically read from each of the connected units during first startup of the CNC and then recorded. During the second or later startup, the ID information recorded during first startup can be compared with the ID information read this time on the screen to check whether the configuration of the connected units is changed. (If there is a difference between them, the alarm mark (*) appears.)

The recorded ID information can be edited. Therefore, the ID information of an unit that does not have ID information can be displayed. (However, the alarm mark (*) indicating a difference between these IDs appears.)

Parameter

| | | | | | | | | |
|------|----|----|----|----|----|-----|----|----|
| | #7 | #6 | #5 | #4 | #3 | #2 | #1 | #0 |
| 1807 | | | | | | SWP | | |

[Data type] Bit

SWP Specifies what to perform when the α i servo amplifier is in the warning state (such as a fan stop).

0 : An alarm is issued when the amplifier is in the warning state.

Automatic operation is placed on feed hold, causing the servo axes to decelerate until they stop.

1 : No alarm is issued when the amplifier is in the warning state.

Automatic operation continues.

The servo motors are de-energized when state transition occurs from warning to alarm.

| | | | | | | | | |
|-------|----|----|----|----|----|----|-----|-----|
| | #7 | #6 | #5 | #4 | #3 | #2 | #1 | #0 |
| 13112 | | | | | | | SVI | IDW |

[Data type] Bit

IDW The edit of the servo information screen or the spindle information screen is:

0 : Prohibited

1 : Allowed

SVI The servo information screen is:

0 : Displayed

1 : Not displayed

Displaying the servo ID screen

- 1 Press the  function key, then press the [SYSTEM] soft key.
- 2 Press the [SV-INF] soft key to display the screen as shown below.

```

SERVO INFORMATION                                00000 N00000

X AXIS
SERVO MOTOR SPEC A06B-0268-B100
SERVO MOTOR S/N  C00ZB1111
PULSECODER SPEC. A860-2000-T301
PULSECODER S/N    00000001
SERVO AMP SPEC.   A06B-6114-H211
SERVO AMP S/N    V01311111
PSM SPEC.        A06B-6087-H126#000001
PSM S/N          V01311111

MDI **** * * * *          19:12:26
{SYSTEM}{SV-INF}{SP-INF}{          }{          }
    
```

NOTE

Servo information is stored in flash ROM. If there is a difference between the servo information in flash ROM and the actual servo information, the corresponding items are preceded by *, as shown below.

```

SERVO INFORMATION                                00000 N00000

X AXIS
SERVO MOTOR SPEC A06B-0268-B100
SERVO MOTOR S/N  C00ZB1111
PULSECODER SPEC. A860-2000-T301
PULSECODER S/N    00000001
*SERVO AMP SPEC.   A06B-6114-H211
*SERVO AMP S/N    V01311111
PSM SPEC.        A06B-6087-H126#000001
PSM S/N          V01311111

) _
MDI **** * * * *          19:12:26
{SYSTEM}{SV-INF}{SP-INF}{          }{(OPRT) }
    
```

Additional Information

Even if replacement is performed reasonably such as for repairing, this function incorrectly indicates the * mark when it detects the replacement.

To clear the * mark, follow the steps below to update the registered data, as described in the editing section later.

- (1) Make the registered data editable. (Parameter IDW (No. 13112#0) = 1)
- (2) On the edit screen, place the cursor on the item from which you want to delete the * mark.
- (3) Operate the soft keys [CHANGE], [INPUT], and [SAVE] in that order.

Editing the servo ID screen

- 1 Assume that parameter No.13112#0(IDW) = 1.
- 2 Press the MDI switch on the machine operator's panel.
- 3 Follow the steps shown in "Displaying the servo ID screen" to display the screen as shown below.



```

SERVO INFORMATION                                00000 N00000

  X AXIS
SERVO MOTOR SPEC  A06B-0268-B100
SERVO MOTOR S/N   C00ZB1111
PULSECODER SPEC. A860-2000-T301
PULSECODER S/N   00000001
SERVO AMP SPEC.  A06B-6114-H211
SERVO AMP S/N   V01311111
PSM SPEC.       A06B-6087-H126#000001
PSM S/N         V01311111

} _
MDI **** ** * 19:12:26
{ SYSTEM } { SV-INF } { SP-INF } {      } { (OPRT) }

```

- 4 To move the cursor on the screen, use the  and  keys.

Screen operation

| Mode | Key operation | Use |
|--------------|------------------|---|
| Viewing (*1) | Page key | Scrolls up or down on a screen-by-screen basis. |
| Editing (*2) | Soft key [INPUT] | Replace the selected ID information at the cursor position with the character string in key-in buffer. |
| | [CANCEL] | Deletes the character string in key-in buffer. |
| | [CHANGE] | Transfers the selected ID information at the cursor position that was sent by the servo, to key-in buffer. Only the items preceded by * (*3) are valid. |
| | [SAVE] | Saves the ID information that has been changed on the servo information screen in flash ROM. |
| | [RELOAD] | Cancels the ID information that has been changed on the servo information screen and loads ID information from flash ROM. |
| | Page key | Scrolls up or down on a screen-by-screen basis. |
| | Cursor key | Scrolls up or down the selection of ID information. |

*1 Viewing mode: when parameter No.13112#0 = 0

*2 Editing mode: when parameter No.13112#0 = 1

*3 Servo information is stored in flash ROM. If there is a difference between the servo information in flash ROM and the actual servo information, the corresponding items are preceded by *.

```

SERVO INFORMATION                                00000 N00000

  X AXIS
SERVO MOTOR SPEC  A06B-0268-B100
SERVO MOTOR S/N   C00ZB1111
PULSECODER SPEC. A860-2000-T301
PULSECODER S/N    00000001
*SERVO AMP SPEC.  A06B-6114-H211
*SERVO AMP S/N    V01311111
PSM SPEC.         A06B-6087-H126#000001
PSM S/N           V01311111

} _
MDI **** * 19:12:26
{SYSTEM}{SV-INF}{SP-INF}{ }{(OPRT)}

```

Note

For axes that are not used by the α i servo system, ID information of connected units cannot be obtained.

7 AC SPINDLE (SERIAL INTERFACE)

This chapter outlines the serial interface and analog interface spindle amplifiers and explains related parameters.

| | |
|--|-----|
| 7.1 AC SPINDLE (SERIAL INTERFACE) | 427 |
| 7.1.1 Outline of Spindle Control | 427 |
| 7.1.2 Spindle Setting and Tuning Screen | 430 |
| 7.1.3 Automatic Setting of Standard Parameters | 438 |
| 7.1.4 Warning Interface for the αi Spindle | 440 |
| 7.1.5 αi Spindle Error State Messages | 442 |
| 7.1.6 αi Spindle Information Screen | 443 |
| 7.2 AC SPINDLE (ANALOG INTERFACE) | 447 |
| 7.2.1 Outline of Spindle Control | 447 |

7.1 AC SPINDLE (SERIAL INTERFACE)

7.1.1 Outline of Spindle Control

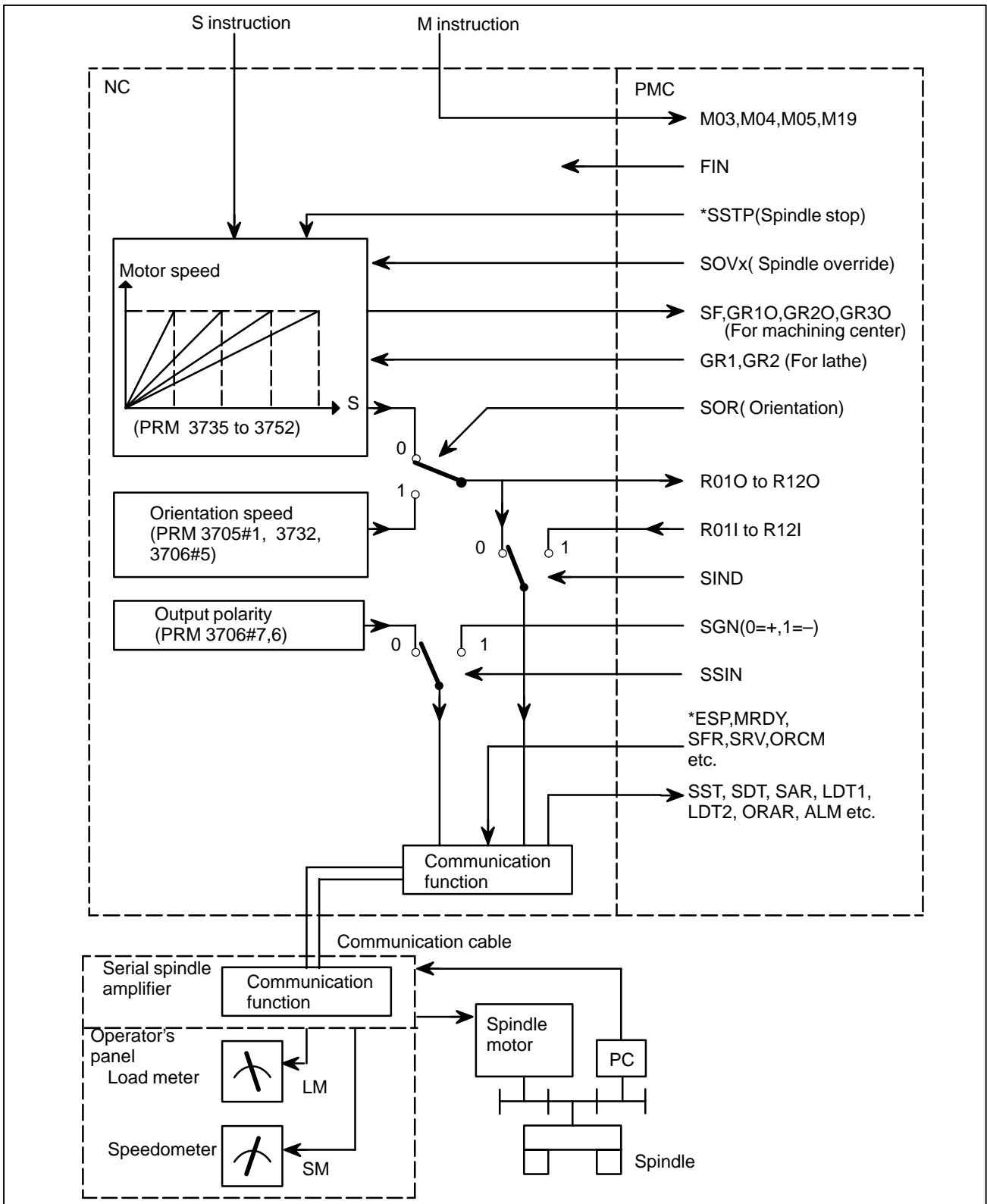

7.1.1.1

**Method A of gear change
for machining center
(PRM 3705#2=0)**

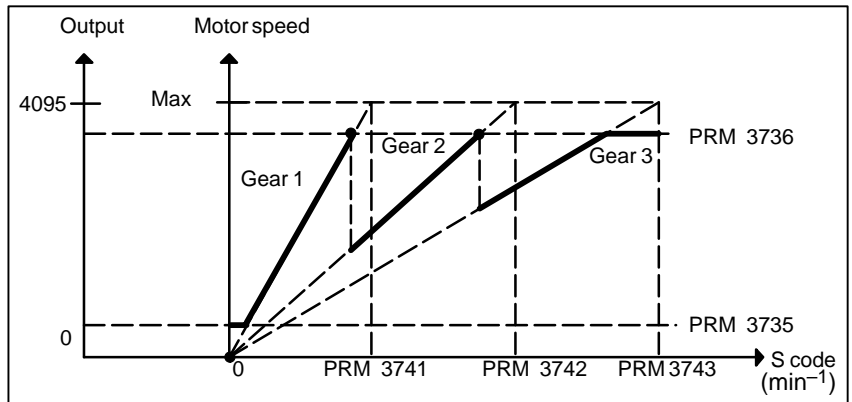

7.1.1.2

**Method B of gear change
for machining center
(PRM 3705#2=1)**

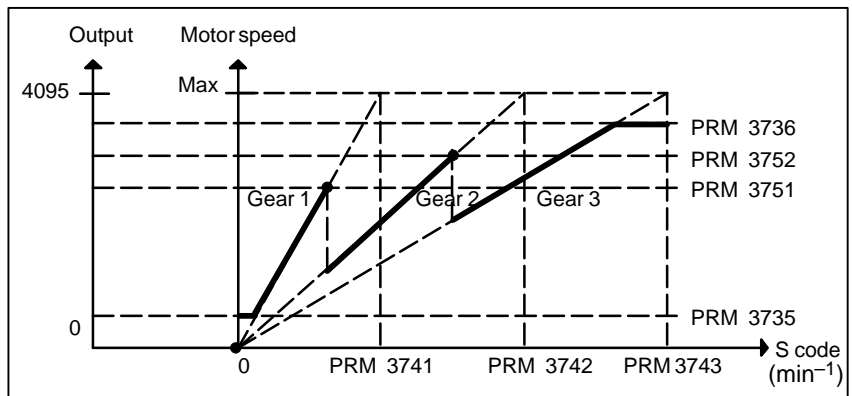

7.1.1.3

T series

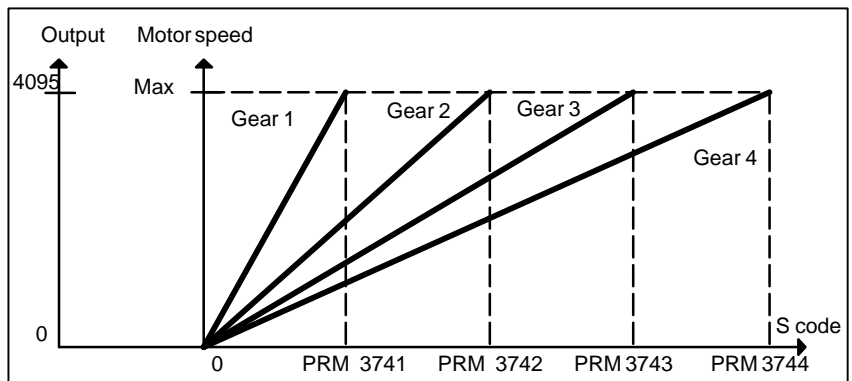

7.1.2 Spindle Setting and Tuning Screen

7.1.2.1 Display method

(1) Confirm the parameters

| | | | | | | | | |
|------|----|----|----|----|----|----|-----|----|
| | #7 | #6 | #5 | #4 | #3 | #2 | #1 | #0 |
| 3111 | | | | | | | SPS | |

Bit1 (SPS) 0 : The spindle tuning screen is not displayed.

☆ 1 : The spindle tuning screen is displayed.



(2) Press the  key to select the screen for setting parameters and other data.

(3) Press the continuous menu key .

(4) Press the soft key **[SP.PRM]**. Then, the spindle setting and tuning screen appears.

(5) The following screens are provided. These screens can be selected using soft keys.

- 1) **[SP.SET]** : Spindle setting screen
- 2) **[SP.TUN]** : Spindle tuning screen
- 3) **[SP.MON]** : Spindle monitor screen

(6) With the page keys  , a spindle to be displayed can be selected (only when multiple serial spindles are connected).

7.1.2.2 Spindle setting screen

| | |
|------------------------|-------------|
| SPINDLE SETTING | |
| (1) GEAR SELECT | : 1 |
| (2) SPINDLE | : S11 |
| (PARAMETER) | |
| (3) GEAR RATIO | 50 |
| (4) MAX SPINDLE SPEED | 3000 |
| (5) MAX MOTOR SPEED | 6000 |
| (6) MAX C AXIS SPEED | 100 |

- **Gear selection**

The gear select status on the machine side is displayed.

| Indication | CTH1 | CTH2 |
|------------|------|------|
| 1 | 0 | 0 |
| 2 | 0 | 1 |
| 3 | 1 | 0 |
| 4 | 1 | 1 |

- **Spindle**

Select a spindle for which data is to be set.

S11: Main spindle amplifier for the 1st spindle

S12: Subspindle amplifier for the 1st spindle

S21: Main spindle amplifier for the 2nd spindle

S22: Subspindle amplifier for the 2nd spindle

- **Parameters**

| | S11:1st Main | S12:1st Sub | S21:2nd Main | S22:2nd Sub |
|----------------------------|--------------|-------------|--------------|-------------|
| Gear ratio(HIGH) | 4056 | 4216 | 4056 | 4216 |
| Gear ratio(MIDIUM HIGH) | 4057 | | 4057 | |
| Gear ratio(MIDIUM LOW) | 4058 | 4217 | 4058 | 4217 |
| Gear ratio(LOW) | 4059 | | 4059 | |
| Max. spindle speed (gear1) | 3741 | | 3741 | |
| Max. spindle speed (gear2) | 3742 | | 3742 | |
| Max. spindle speed (gear3) | 3743 | | 3743 | |
| Max. spindle speed (gear4) | 3744 | | 3744 | |
| Max. motor speed | 4020 | 4196 | 4020 | 4196 |
| Max. C axis speed | 4021 | None | 4021 | None |

7.1.2.3

Spindle tuning screen

| SPINDLE TUNING | | | |
|----------------|------|---------------|-----|
| OPERATION | : | SPEED CONTROL | |
| GEAR SELECT | : | 1 | |
| SPINDLE | : | S11 | |
| (PARAMETER) | | (MONITOR) | |
| PROP.GAIN | 20 | MOTOR SPEED | 100 |
| INT.GAIN | 50 | SPINDLE SPEED | 150 |
| LOOP GAIN | 3000 | POS ERR S1 | 100 |
| MOTOR VOLT | 30 | POS ERR S2 | 103 |
| TIME CONST | 100 | SYN.ERR | 3 |
| REF. SHIFT | 2046 | | |

- **Operation mode**

- 1 : Normal operation
- 2 : Orientation
- 3 : Synchronization control
- 4 : Rigid tapping
- 5 : Cs contour control
- 6 : Spindle positioning control

- **Displayed parameters** The displayed parameters vary depending on the operation mode.

| Spindle position- ing control | Normal operation | Orientation | Synchronization control | Rigid tapping | Cs contour control |
|--|---|--|---|--|--|
| Proportional gain Integral gain Loop gain Motor voltage ZRN gain (%) Shift reference position | Proportional gain Integral gain Motor voltage Regenerative power | Proportional gain Integral gain Loop gain Motor voltage ORAR gain (%) Shift spindle stop position Shift reference position | Proportional gain Integral gain Loop gain Motor voltage Acceleration/deceleration constant (%) Shift reference position | Proportional gain Integral gain Loop gain Motor voltage ZRN gain Shift reference position | Proportional gain Integral gain Loop gain Motor voltage ZRN gain (%) Shift reference position |

Note) For the parameter numbers corresponding to the displayed parameter items, see Section 7.1.2.5.

- **Displayed monitoring items** The displayed monitoring items vary depending on the operation mode.

| Spindle position- ing control | Normal operation | Orientation | Synchronization control | Rigid tapping | Cs contour control |
|--|------------------------------|---|---|--|---|
| Motor speed Feedrate Position deviation S1 | Motor speed Spindle speed | Motor speed Spindle speed Position deviation S1 | Motor speed Spindle speed Position deviation S1 Position deviation S2 Synchronous deviation | Motor speed Spindle speed Position deviation S1 Position deviation Z Synchronous deviation | Motor speed Spindle speed Position deviation S1 |

Note 1)

$$\text{Motor speed} [\text{min}^{-1}] = \frac{|\text{Spindle data}|}{16383} \times \text{Max. Motor speed.}(* 1)$$

(*1) Parameter 4020: Main spindleParameter 4196: Subspindle

Note 2) The spindle speed in Cs contour control mode is in degrees/min.

7.1.2.4

Spindle monitor screen

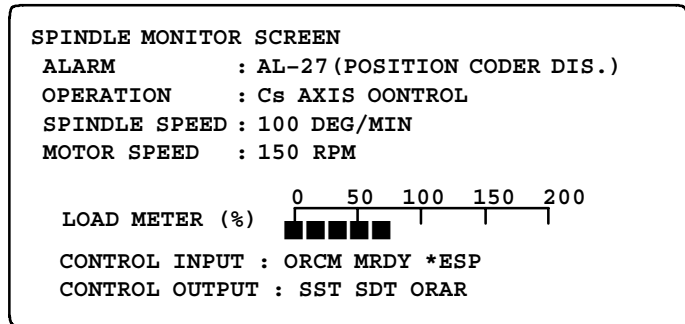

• Spindle alarm

- 1: Motor overheated
- 2: Speed deviation excessive
- 3: Fuse blow of DC link
- 4: Fuse blow of AC inputline
- 5: Fuse blow of DC voltage
- 7: Excessive speed
- 9: Heat sink overheat
- 10: Low voltage of AC input
- 11: Excess voltage in DC link
- 12: Excess current in DC link
- 13: CPU internal data memory error
- 18: ROM SUM check error
- 19: U phase current offset excessive
- 20: V phase current offset excessive
- 24: Serial data transmission abnormal
- 25: Serial data transmission stop
- 26: Cs axis speed detecting signal failure
- 27: Position coder signal disconnection
- 28: Cs pos.detect signal disconnection
- 29: Short time overload
- 30: Input circuit excess current
- 31: Speed detecting signal disconnection
- 32: SLC LSI internal RAM abnormal
- 33: DC link charging insufficient
- 34: Parameter abnormal setting
- 35: Gear ratio data excessive
- 36: Error counter overflow
- 37: Speed detecting unit error setting
- 38: Magnetic sensor signal abnormal
- 39: Alarm of one revolution signal for Cs axis control is detected
- 40: Alarm of one revolution signal for Cs axis control is not detected
- 41: Erroneous detection of the position coder one revolution signal
- 42: Undetection of the position coder one revolution signal
- 46: Erroneous detection of the position coder one revolution signal on threading
- 47: Abnormal position coder signal
- 48: Erroneous detection of position coder one revolution signal

- **Operation**

Following 6 modes are available:

- Normal operation
- Orientation
- Synchronous operation
- Rigid tapping
- Cs contour control
- Spindle positioning control

- **Load meter**

The load meter displays spindle load in a unit of 10%.

$$1) \text{ Load meter}[\%] = \frac{\text{Load meter data}}{32767} \times \text{Max.output value of load meter (*)}$$

(*) PRM 4127: Main
PRM 4274: Sub.

- **Control input signal**

Max.10 signals those are ON are displayed from the following signals:

| | |
|------------------------------------|--------------------------------------|
| TLML : Torque limit command (low) | SPSL : Spindle selection signal |
| TLMH : Torque limit command (high) | MCFN : Power line switching |
| CTH1 : Gear signal 1 | SOCN : Soft start/stop cancel |
| CTH2 : Gear signal 2 | RSL : Output switching request |
| SRV : Spindle reverse rotation | RCH : Power line state confirm |
| SFR : Spindle forward rotation | INDX : Orientation stop pos. change |
| ORCM : Spindle orientation | ROTA : Rotation direction of ORCM |
| MEDY : Machine ready | NRRO : Short-cut of ORCM |
| ARST : Alarm reset signal | INTG : Speed integral control signal |
| *ESP : Emergency stop | DEFM : Referencial mode command |

- **Control output signals**

Max. 10 signals those are ON are displayed from the following signals:

| | |
|--------------------------------|--------------------------------------|
| ALM : Alarm signal | TML5 : Torque limitation |
| SST : Speed zero signal | ORAR : Orientation end signal |
| SDT : Speed detecting signal | CHP : Power line switched signal |
| SAR : Speed arrival signal | CFIN : Spindle switch complete |
| LDT1 : Load detecting signal 1 | RCHP : Output switch signal |
| LDT2 : Load detecting signal 2 | RCFN : Output switch complete signal |

7.1.2.5

Correspondence between operation mode and parameters on spindle tuning screen

- Normal operation mode

| | S11: 1st Main | S12: 1st Sub | S21: 2nd Main | S22: 2nd Sub |
|-------------------------|--------------------------|-------------------------|--------------------------|-------------------------|
| Proportionalgain(HIGH) | 4040 | 4206 | 4040 | 4206 |
| Proportional gain (LOW) | 4041 | 4207 | 4041 | 4207 |
| Integralgain(HIGH) | 4048 | 4212 | 4048 | 4212 |
| Integralgain(LOW) | 4049 | | 4049 | |
| Motor voltage | 4083 | 4236 | 4083 | 4236 |
| Regenerative power | 4080 | 4231 | 4080 | 4231 |

- Orientation mode

| | S11: 1st Main | S12: 1st Sub | S21: 2nd Main | S22: 2nd Sub |
|--|--------------------------|-------------------------|--------------------------|-------------------------|
| Proportionalgain(HIGH) | 4042 | 4208 | 4042 | 4208 |
| Proportional gain (LOW) | 4043 | 4209 | 4043 | 4209 |
| Integralgain(HIGH) | 4050 | 4213 | 4050 | 4213 |
| Integralgain(LOW) | 4051 | | 4051 | |
| Loop gain (HIGH) | 4060 | 4218 | 4060 | 4218 |
| Loop gain (MID, HIGH) | 4061 | | 4061 | |
| Loop gain (MID, LOW) | 4062 | 4219 | 4062 | 4219 |
| Loop gain (LOW) | 4063 | | 4063 | |
| Motor voltage | 4084 | 4237 | 4084 | 4237 |
| Gain change upon completion of orientation | 4064 | 4220 | 4064 | 4220 |
| Stop position shift | 4077 | 4228 | 4077 | 4228 |
| PC-type orientation stop position | 4031 | 4204 | 4031 | 4204 |

- **Synchronization control mode**

Numerals are parameter numbers :

| | S11: 1st Main | S12: 1st Sub | S21: 2nd Main | S22: 2nd Sub |
|------------------------------|--------------------------|-------------------------|--------------------------|-------------------------|
| Proportionalgain(HIGH) | 4044 | 4210 | 4044 | 4210 |
| Proportionalgain(LOW) | 4045 | 4211 | 4045 | 4211 |
| Integralgain(HIGH) | 4052 | 4214 | 4052 | 4214 |
| Integralgain(LOW) | 4053 | | 4053 | |
| Position loop gain(HIGH) | 4065 | 4221 | 4065 | 4221 |
| Position loop gain(MID,HIGH) | 4066 | | 4066 | |
| Position loop gain(MID,LOW) | 4067 | 4222 | 4067 | 4222 |
| Position loop gain(LOW) | 4068 | | 4068 | |
| Motor voltage | 4085 | 4238 | 4085 | 4238 |
| Acc./Dec. time constant | 4032 | | 4032 | |
| Shift amount | 4034 | | 4034 | |

- **Rigid tapping mode**

Numerals are parameter numbers :

| | S11: 1st Main | S12: 1st Sub | S21: 2nd Main | S22: 2nd Sub |
|------------------------------|--------------------------|-------------------------|--------------------------|-------------------------|
| Proportionalgain(HIGH) | 4044 | 4210 | 4044 | 4210 |
| Proportionalgain(LOW) | 4045 | 4211 | 4045 | 4211 |
| Integralgain(HIGH) | 4052 | 4214 | 4052 | 4214 |
| Integralgain(LOW) | 4053 | | 4053 | |
| Position loop gain(HIGH) | 4065 | 4221 | 4065 | 4221 |
| Position loop gain(MID,HIGH) | 4066 | | 4066 | |
| Position loop gain(MID,LOW) | 4067 | 4222 | 4067 | 4222 |
| Position loop gain(LOW) | 4068 | | 4068 | |
| Motor voltage | 4085 | 4238 | 4085 | 4238 |
| ZRN gain % | 4091 | 4239 | 4091 | 4239 |
| Grid shift amount | 4073 | 4223 | 4073 | 4223 |

- **Cs contour control mode**

Numerals are parameter numbers :

| | S11: 1st Main | S12: 1st Sub | S21: 2nd Main | S22: 2nd Sub |
|------------------------------|--------------------------|-------------------------|--------------------------|-------------------------|
| Proportional gain(HIGH) | 4046 | | 4046 | |
| Proportional gain (LOW) | 4047 | | 4047 | |
| Integral gain(HIGH) | 4054 | | 4054 | |
| Integral gain(LOW) | 4055 | | 4055 | |
| Position loop gain(HIGH) | 4069 | | 4069 | |
| Position loop gain(MID,HIGH) | 4070 | | 4070 | |
| Position loop gain(MID,LOW) | 4071 | | 4071 | |
| Position loop gain(LOW) | 4072 | | 4072 | |
| Motor voltage | 4086 | | 4086 | |
| ZRN gain % | 4092 | | 4092 | |
| Reference position shift | 4135 | | 4135 | |

- **Spindle positioning control mode**

| | S11: 1st Main | S12: 1st Sub | S21: 2nd Main | S22: 2nd Sub |
|------------------------------|--------------------------|-------------------------|--------------------------|-------------------------|
| Proportional gain(HIGH) | 4044 | 4210 | 4044 | 4210 |
| Proportional gain (LOW) | 4045 | 4211 | 4045 | 4211 |
| Integral gain(HIGH) | 4052 | 4214 | 4052 | 4214 |
| Integral gain(LOW) | 4053 | | 4053 | |
| Position loop gain(HIGH) | 4065 | 4221 | 4065 | 4221 |
| Position loop gain(MID,HIGH) | 4066 | | 4066 | |
| Position loop gain(MID,LOW) | 4067 | 4222 | 4067 | 4222 |
| Position loop gain(LOW) | 4068 | | 4068 | |
| Motor voltage | 4085 | 4238 | 4085 | 4238 |
| ZRN gain % | 4091 | 4239 | 4091 | 4239 |
| Reference position shift | 4073 | 4223 | 4073 | 4223 |

7.1.3 Automatic Setting of Standard Parameters

The standard parameters related to each motor model can be set automatically.

- The specifications for controlling a motor depend on the specifications defined by the machine tool builder. The parameters defined by the machine tool builder are set as the standard values (initial values) by this automatic setting function.

Therefore, when performing automatic operation, always set parameters properly according to the parameter list (parameters 4000 and later).

1. Turn on the power in the emergency stop state.
2. Set bit 7 of parameter 4019 to 1.

| | | | | | | | | |
|------|------|----|----|----|----|----|----|----|
| | #7 | #6 | #5 | #4 | #3 | #2 | #1 | #0 |
| 4019 | LDSP | | | | | | | |

Bit 7 (LDSP) The parameters for the serial interface spindle are:

0 : Not set automatically.

☆ 1 : Set automatically.

3. Set a motor model code.

| | |
|------|------------------|
| 4133 | Motor model code |
|------|------------------|

(Reference: Example of motor model code of αi spindle motor)

| Code | Motor model | Amplifier |
|------|---|---------------------------------|
| 301 | $\alpha i0.5/10000(3000/10000\text{min}^{-1})$ | $\alpha i\text{SP}2.2$ |
| 302 | $\alpha i1/10000(3000/10000\text{min}^{-1})$ | $\alpha i\text{SP}2.2$ |
| 304 | $\alpha i1.5/10000(1500/10000\text{min}^{-1})$ | $\alpha i\text{SP}5.5$ |
| 305 | $\alpha i1.5/15000(3000/15000\text{min}^{-1})$ | $\alpha i\text{SP}15$ |
| 306 | $\alpha i2/10000(1500/10000\text{min}^{-1})$ | $\alpha i\text{SP}5.5$ |
| 307 | $\alpha i2/15000(3000/15000\text{min}^{-1})$ | $\alpha i\text{SP}22$ |
| 308 | $\alpha i3/10000(1500/10000\text{min}^{-1})$ | $\alpha i\text{SP}5.5$ |
| 309 | $\alpha i3/12000(1500/12000\text{min}^{-1})$ | $\alpha i\text{SP}11$ |
| 310 | $\alpha i6/10000(1500/10000\text{min}^{-1})$ | $\alpha i\text{SP}11$ |
| 311 | $\alpha i0.5/10000\text{HV}(3000/10000\text{min}^{-1})$ | $\alpha i\text{SP}5.5\text{HV}$ |
| 312 | $\alpha i8/8000(1500/8000\text{min}^{-1})$ | $\alpha i\text{SP}11$ |
| 313 | $\alpha i1/10000\text{HV}(3000/10000\text{min}^{-1})$ | $\alpha i\text{SP}5.5\text{HV}$ |
| 314 | $\alpha i12/7000(1500/7000\text{min}^{-1})$ | $\alpha i\text{SP}15$ |
| 315 | $\alpha i1.5/10000\text{HV}(1500/10000\text{min}^{-1})$ | $\alpha i\text{SP}5.5\text{HV}$ |
| 316 | $\alpha i15/7000(1500/7000\text{min}^{-1})$ | $\alpha i\text{SP}22$ |
| 317 | $\alpha i2/10000\text{HV}(1500/10000\text{min}^{-1})$ | $\alpha i\text{SP}5.5\text{HV}$ |
| 318 | $\alpha i18/7000(1500/7000\text{min}^{-1})$ | $\alpha i\text{SP}22$ |
| 319 | $\alpha i3/10000\text{HV}(1500/10000\text{min}^{-1})$ | $\alpha i\text{SP}5.5\text{HV}$ |
| 320 | $\alpha i22/7000(1500/7000\text{min}^{-1})$ | $\alpha i\text{SP}26$ |
| 321 | $\alpha i6/10000\text{HV}(1500/10000\text{min}^{-1})$ | $\alpha i\text{SP}11\text{HV}$ |
| 322 | $\alpha i30/6000(1150/6000\text{min}^{-1})$ | $\alpha i\text{SP}45$ |
| 323 | $\alpha i40/6000(1500/6000\text{min}^{-1})$ | $\alpha i\text{SP}45$ |
| 324 | $\alpha i50/4500(1150/4500\text{min}^{-1})$ | $\alpha i\text{SP}55$ |

| Code | Motor model | Amplifier |
|------|--|------------------|
| 325 | $\alpha i18/8000HV(1500/8000min^{-1})$ | $\alpha iSP11HV$ |
| 326 | $\alpha i12/7000HV(1500/7000min^{-1})$ | $\alpha iSP15HV$ |
| 327 | $\alpha i15/7000HV(1500/7000min^{-1})$ | $\alpha iSP30HV$ |
| 328 | $\alpha i22/7000HV(1500/7000min^{-1})$ | $\alpha iSP30HV$ |
| 329 | $\alpha i30/6000HV(1150/6000min^{-1})$ | $\alpha iSP45HV$ |
| 401 | $\alpha i16/12000(1500/12000,4000/12000min^{-1})$ | $\alpha iSP11$ |
| 402 | $\alpha i18/10000(1500/10000,4000/10000min^{-1})$ | $\alpha iSP11$ |
| 403 | $\alpha i12/10000(1500/10000,4000/10000min^{-1})$ | $\alpha iSP15$ |
| 404 | $\alpha i15/10000(1500/10000,4000/10000min^{-1})$ | $\alpha iSP22$ |
| 405 | $\alpha i18/10000(1500/10000,4000/10000min^{-1})$ | $\alpha iSP22$ |
| 406 | $\alpha i22/10000(1500/10000,4000/10000min^{-1})$ | $\alpha iSP26$ |
| 407 | $\alpha i1p12/6000(500/1500,750/6000min^{-1})$ | $\alpha iSP11$ |
| 408 | $\alpha i1p15/6000(500/1500,750/6000min^{-1})$ | $\alpha iSP15$ |
| 409 | $\alpha i1p18/6000(500/1500,750/6000min^{-1})$ | $\alpha iSP15$ |
| 410 | $\alpha i1P22/6000(500/1500,750/6000min^{-1})$ | $\alpha iSP22$ |
| 411 | $\alpha i1p30/6000(400/1500,575/6000min^{-1})$ | $\alpha iSP22$ |
| 412 | $\alpha i1p40/6000(400/1500,575/6000min^{-1})$ | $\alpha iSP26$ |
| 413 | $\alpha i1p50/6000(575/1500,1200/6000min^{-1})$ | $\alpha iSP26$ |
| 414 | $\alpha i1p60/4500(400/1500,750/4500min^{-1})$ | $\alpha iSP30$ |
| 415 | $\alpha i1100/4000HV(1000/3000,2000/4000min^{-1})$ | $\alpha iSP75HV$ |
| 418 | $\alpha i1p40/6000HV(400/1500,575/6000min^{-1})$ | $\alpha iSP30HV$ |

(Reference: Example of motor model code of βi spindle motor)

| Code | Motor model | Amplifier |
|------|---------------------------------------|-------------------|
| 332 | $\beta i13/10000(2000/10000min^{-1})$ | $\beta iSVSP-5.5$ |
| 333 | $\beta i16/10000(2000/10000min^{-1})$ | $\beta iSVSP-11$ |
| 334 | $\beta i18/8000(2000/8000min^{-1})$ | $\beta iSVSP-11$ |
| 335 | $\beta i12/7000(2000/7000min^{-1})$ | $\beta iSVSP-15$ |

For motor model codes other than the above, refer to the parameter manual for spindles.

The α Series cannot be used with the $0i$ Mate.

4. Turn off the power then back on. Then, the parameters are read.

7.1.4 Warning Interface for the αi Spindle

Overview

For the αi spindle, the warning state can be reported before an alarm is issued. When the warning state is entered, a report to the PMC is sent. For example, this signal can be used for retracting tools or reducing cutting load from the time a warning occurs by the time an overheat alarm occurs. In addition, diagnostic information also contains warning numbers.

Signal

Spindle warning detailed signals SPWRN1 to 9 <F264#0 to #7, F265#0>

[Classification] Output

[Function] Reports the warning number corresponding to the state of the αi spindle amplifier.

[Output condition] When the αi spindle is in the warning state, a warning number consisting of SPWRN1 to SPWRN9 is output as nine-bit binary data. If warnings occurred on multiple αi spindle amplifiers, the warning number of the αi spindle having the smallest axis number is output. However, when there is no αi spindle or the system configuration of the spindle includes an additional spindle that is older than the αi spindle, this function is invalid for all spindles. The warning numbers and their descriptions are shown below.

| Warning number | Contents | Details |
|----------------|--|---|
| 56 | Internal fan stopped | If the internal fan stops, the warning signal is output. Since the spindle continues to operate at this time, use the PMC to perform processing as needed. About one minute after the warning signal is output, an alarm occurs. |
| 88 | Radiator cooling fan stopped | If the radiator cooling fan stops, the warning signal is output. Since the spindle continues to operate at this time, use the PMC to perform processing as needed. If the main circuit overheats, an alarm occurs. |
| 04 | Open-phase detected in the converter main power supply | If an open-phase is detected in the main power supply, the warning signal is output. Since the spindle continues to operate at this time, use the PMC to perform processing as needed. About one minute (for the PSM) or about five seconds (for the PSMR) after the warning signal is output, an alarm occurs. |

| Warning number | Contents | Details |
|----------------|--|--|
| 58 | Converter main circuit overloaded | If the main circuit of the PSM is overloaded, the warning signal is output. Since the spindle continues to operate at this time, use the PMC to perform processing as needed. About one minute after the warning signal is output, an alarm occurs. |
| 59 | Converter cooling fan stopped | If the PSM cooling fan stops, the warning signal is output. Since the spindle continues to operate at this time, use the PMC to perform processing as needed. About one minute after the warning signal is output, an alarm occurs. |
| 113 | Converter radiator cooling fan stopped | If the PSM radiator cooling fan stops, the warning signal is output. Since the spindle continues to operate at this time, use the PMC to perform processing as needed. If the PSM main circuit overheats, an alarm occurs. |

Signal address

| | | | | | | | | |
|------|--------|--------|--------|--------|--------|--------|--------|--------|
| | #7 | #6 | #5 | #4 | #3 | #2 | #1 | #0 |
| F264 | SPWRN8 | SPWRN7 | SPWRN6 | SPWRN5 | SPWRN4 | SPWRN3 | SPWRN2 | SPWRN1 |
| F265 | | | | | | | | SPWRN9 |

Diagnosis screen

The status of a warning is displayed on the following diagnostic screen.

| | |
|-----|----------------------------------|
| 712 | Warning status of first spindle |
| 713 | Warning status of second spindle |
| 732 | Warning status of third spindle |
| 733 | Warning status of fourth spindle |

The number of a warning caused on each spindle is indicated. If there is no warning, 0 is indicated.

NOTE

NOTE

- 1 For spindles that are older than the αi spindle, this function is invalid.
- 2 When the system configuration of the spindle (even another spindle) includes an additional spindle that is older than the αi spindle, this function is invalid.

7.1.5 *αi* Spindle Error State Messages

General

If an error occurs (a yellow LED lights and an error number is displayed) on the *αi* spindle amplifier, the error state is displayed on the diagnosis screen.

Diagnosis screen

| | |
|-----|----------------------------|
| 710 | First-spindle error state |
| 711 | Second-spindle error state |
| 730 | Third-spindle error state |
| 731 | Fourth-spindle error state |

The error number for an error on an individual spindle amplifier is indicated.

If no error occurs, “0” is indicated.

NOTE

- If the system contains an old-type spindle amplifier (such as one for an *α* spindle), no spindle amplifier error is indicated.
- Refer to the *αi* Servo Motor Maintenance Manual and the like for details of the spindle amplifier errors.

7.1.6 *αi* Spindle Information Screen

General

In the *αi* spindle system, ID information output from each of the connected units is obtained and output to the CNC screen.

The units that have ID information are shown below.

(Remark: Some instances of these units do not have ID information.)

- Spindle motor
- Spindle amplifier
- Power supply module

ID information is automatically read from each of the connected units during first startup of the CNC and then recorded. During second or later startup, the ID information recorded during first startup can be compared with the ID information read this time on the screen to check whether the configuration of the connected units is changed. (If there is a difference between them, the alarm mark (*) appears.)

The recorded ID information can be edited. Therefore, the ID information of an unit that does not have ID information can be displayed. (However, the alarm mark (*) indicating a difference between these IDs appears.)

Parameter

| | #7 | #6 | #5 | #4 | #3 | #2 | #1 | #0 |
|-------|----|----|----|----|----|-----|----|-----|
| 13112 | | | | | | SPI | | IDW |

[Data type] Bit

IDW The edit of the servo information screen or the spindle information screen is:

- 0 : Prohibited
- 1 : Allowed

SPI The spindle information screen is:

- 0 : Displayed
- 1 : Not displayed

Displaying the spindle information screen

- 1 Press the  function key, then press the [SYSTEM] soft key.
- 2 Press the [SP-INF] soft key to display the screen as shown below.

```

SPINDLE INFORMATION                                00000 N00000

  S1
SP MOTOR SPEC          A06B-0852-B088#0007
SP MOTOR S/N          C99XA1234

SP AMP SPEC           A06B-6102-H106#H520CE
SP AMP S/N           V0020090601
PSM SPEC.            A06B-6087-H126#000001
PSM S/N             V0020031702

) _
MDI **** * 19:12:05
{SYSTEM}{SV-INF){SP-INF}{ }{ }

```

NOTE

Spindle information is stored in flash ROM. If there is a difference between the spindle information in flash ROM and the actual spindle information, the corresponding items are preceded by *, as shown below.

```

SPINDLE INFORMATION                                00000 N00000

  S1
SP MOTOR SPEC          A06B-0852-B088#0007
SP MOTOR S/N          C99XA1234

*SP AMP SPEC           A06B-6102-H106#H520CE
*SP AMP S/N           V0020090601
PSM SPEC.            A06B-6087-H126#000001
PSM S/N             V0020031702

) _
MDI **** * 19:12:05
{SYSTEM}{SV-INF){SP-INF}{ }{ }

```

Additional Information

Even if replacement is performed reasonably such as for repairing, this function incorrectly indicates the * mark when it detects the replacement.

To clear the * mark, follow the steps below to update the registered data, as described in the editing section later.

- (1) Make the registered data editable. (Parameter IDW (No. 13112#0) = 1)
- (2) On the edit screen, place the cursor on the item from which you want to delete the * mark.
- (3) Operate the soft keys [CHANGE], [INPUT], and [SAVE] in that order.

Editing the spindle information screen

- 1 Assume that parameter No.13112#0(IDW) = 1.
- 2 Press the MDI switch on the machine operator’s panel.
- 3 Follow the steps shown in "Displaying the spindle ID screen" to display the screen as shown below.



```

SPINDLE INFORMATION                00000 N00000

  S1
SP MOTOR SPEC          A06B-0852-B088#0007
SP MOTOR S/N           C99XA1234

SP AMP SPEC            A06B-6102-H106#H520CE
SP AMP S/N             V0020090601
PSM SPEC.              A06B-6087-H126#000001
PSM S/N                V0020031702

} _
MDI **** * 19:12:05
{SYSTEM}{SV-INF}{SP-INF}{      }{(OPRT)}
    
```

- 4 To move key-in buffer on the screen, use the  and  keys.

Screen operation on the editing screen

| Mode | Key operation | Use |
|--------------|------------------|---|
| Viewing (*1) | Page key | Scrolls up or down on a screen-by-screen basis. |
| Editing (*2) | Soft key [INPUT] | Replace the selected ID information at the cursor position with the character string in key-in buffer. |
| | [CANCEL] | Deletes the character string in key-in buffer. |
| | [CHANGE] | Transfers the selected ID information at the cursor position that was sent by the servo, to key-in buffer. Only the items preceded by * (*3) are valid. |
| | [SAVE] | Saves the ID information that has been changed on the spindle information screen in flash ROM. |
| | [RELOAD] | Cancels the ID information that has been changed on the spindle information screen and loads ID information from flash ROM. |
| | Page key | Scrolls up or down on a screen-by-screen basis. |
| | Cursor key | Scrolls up or down the selection of ID information. |

*1 Viewing mode: when parameter No.13112#0 = 0

*2 Editing mode: when parameter No.13112#0 = 1

*3 Spindle information is stored in flash ROM. If there is a difference between the spindle information in flash ROM and the actual spindle information, the corresponding items are preceded by *.

```

SPINDLE INFORMATION                                00000 N00000

  S1
  SP MOTOR SPEC          A06B-0852-B088#0007
  SP MOTOR S/N           C99XA1234

*SP AMP SPEC            A06B-6102-H106#H520CE
*SP AMP S/N             V0020090601
  PSM SPEC.             A06B-6087-H126#000001
  PSM S/N               V0020031702

} _
MDI **** * 19:12:05
{SYSTEM}{SV-INF){SP-INF){      }{(OPRT)}

```



CAUTION

For mixed connection of an αi spindle and a spindle that does not belong to the αi spindle system, ID information of connected units for serial spindle including αi spindles cannot be obtained.

7.2 AC SPINDLE (ANALOG INTERFACE)

7.2.1 Outline of Spindle Control

7.2.1.1 Block diagram

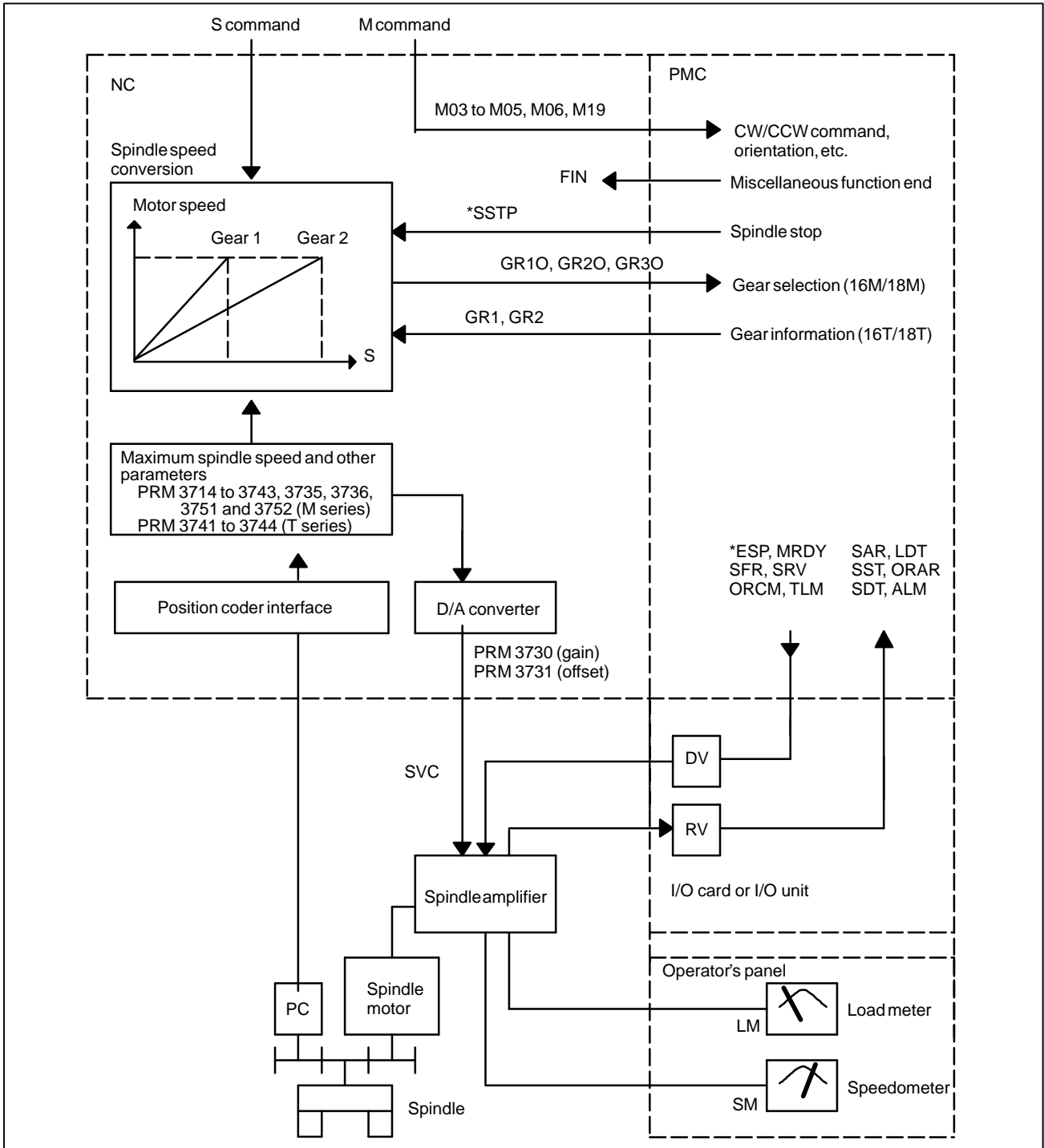

7.2.1.2 Calculation of S analog voltage and related parameters

[M series]

1 Gear change method A (bit 2 of parameter 3705 = 0)

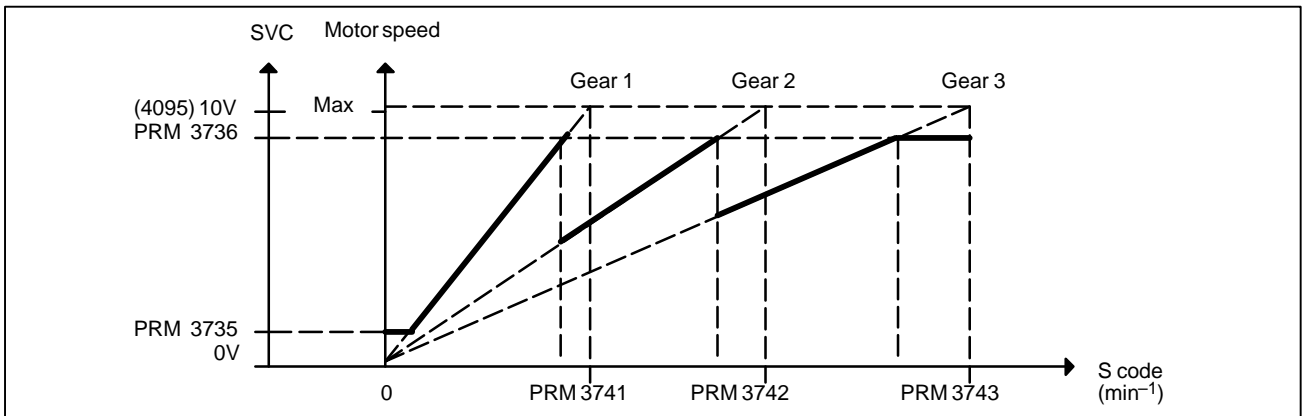

2 Gear change method B (bit 2 of parameter 3705 = 1)

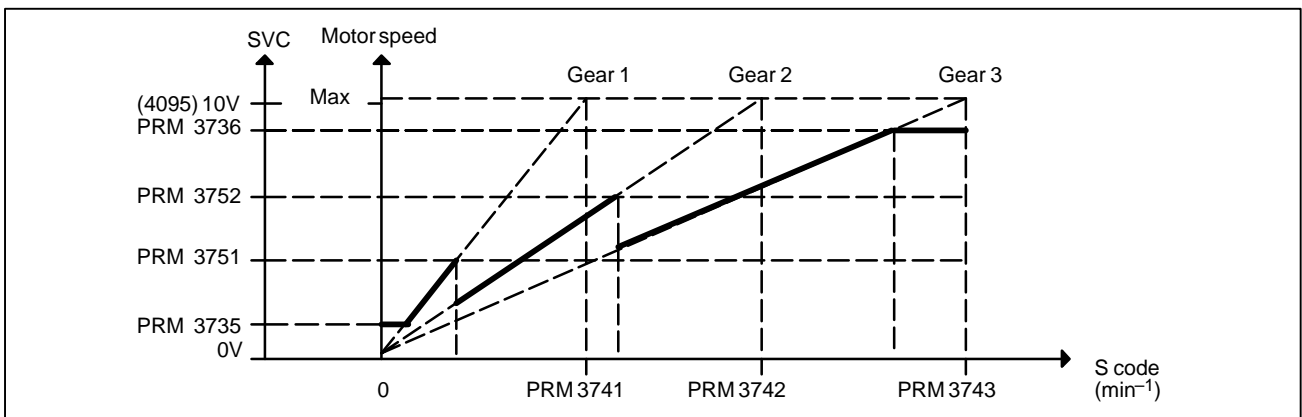

[T series]

Constant surface speed control

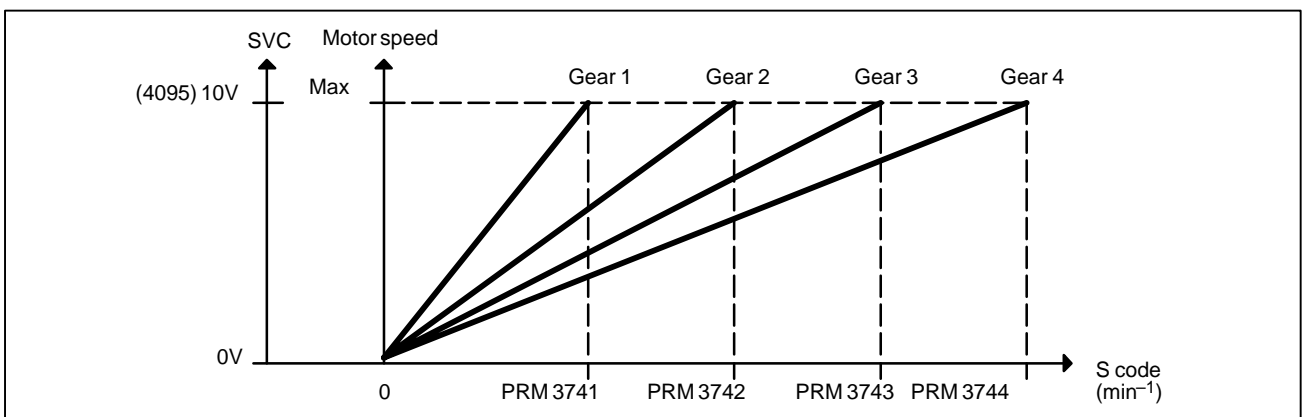

| | | | | | | | | |
|------|-----|-----|----|----|----|----|----|----|
| | #7 | #6 | #5 | #4 | #3 | #2 | #1 | #0 |
| 3706 | TCW | CWM | | | | | | |

| TCW | CWM | Sign of output voltage |
|-----|-----|--|
| 0 | 0 | Analog voltage (+) with both M03 and M04 |
| 0 | 1 | Analog voltage (-) with both M03 and M04 |
| 1 | 0 | (+) with M03, (-) with M04 |
| 1 | 1 | (-) with M03, (+) with M04 |

[M series]

| | | | | | | | | |
|------|----|----|----|----|----|-----|----|----|
| | #7 | #6 | #5 | #4 | #3 | #2 | #1 | #0 |
| 3705 | | | | | | SGB | | |

SGB Spindle speed set when gear change is performed is:

0 : Maximum speed for each gear.

1 : Set by respective parameters. (Parameters 3751, 3752)

| | |
|------|---|
| 3741 | Max. spindle speed of gear 1 (1 to 9999) [min ⁻¹] |
| 3742 | Max. spindle speed of gear 2 (1 to 9999) [min ⁻¹] |
| 3743 | Max. spindle speed of gear 3 (1 to 9999) [min ⁻¹] |
| 3751 | Spindle motor speed at the switch point between gear 1 and gear 2 |
| 3752 | Spindle motor speed at the switch point between gear 2 and gear 3 |

[Data type] Word**[Valid data range]** 0 to 4095

Set a spindle motor speed at each gear switch point when gear switch method B is used (when bit 2 (SGB) of parameter No. 3705 is set to 1).

$$\text{Setting} = \frac{\text{Spindle motor speed at gear switch point}}{\text{Maximum spindle motor speed}} \times 4095$$

| | |
|------|--|
| 3736 | Upper limit of the output to the spindle motor |
| 3735 | Lower limit of the output to the spindle motor |

$$\text{Setting} = \frac{\text{Spindle speed (upper limit/lower limit)}}{\text{Max. spindle speed}} \times 4095$$

[T series]

| | |
|------|---|
| 3741 | Max. spindle speed of gear 1 (1 to 9999) [min ⁻¹] |
| 3742 | Max. spindle speed of gear 2 (1 to 9999) [min ⁻¹] |
| 3743 | Max. spindle speed of gear 3 (1 to 9999) [min ⁻¹] |
| 3744 | Max. spindle speed of gear 4 (1 to 9999) [min ⁻¹] |

7.2.1.3 Tuning S analog voltage (D/A converter)

(1) For M series, change the upper and lower limits as follows:

- When gear change method A is used: Parameter 3736 = 4095, parameter 3735 = 0
- When gear change method B is used: Parameter 3751 = 4095, parameter 3735 = 0

☞ For T series, these changes are not required.

(2) Tuning the D/A converter offset

Specify zero as the spindle speed. Then, by using a digital multimeter, adjust the following parameter so that the voltage at the test pin DA2 on the spindle amplifier printed circuit board is 0 mV.

1 For M series

S0; (Specify the command by MDI operation, then press the cycle start button.)

2 For T series (in case of G-code system A)

G97 S0; (Specify the command by MDI in the same manner as for M series.)

3731

Spindle speed (D/A converter) offset compensation value

(3) Tuning the D/A converter gain

Specify the maximum spindle speed of gear 1. Then, by using a digital multimeter, adjust the following parameter so that the voltage at the test pin DA2 on the spindle amplifier printed circuit board is 10.0 V.

1 For M series

Sxxxx ; (xxxx is the value set in parameter 3741.)
(Specify the command by MDI operation, then press the cycle start button.)

3741

Max. spindle speed of gear 1 (1 to 9999) [min⁻¹]

2 For T series (in case of G-code system A)

G97 Sxxxx ; (xxxx is the value set in parameter 3741.)
(Specify the command by MDI operation, then press the cycle start button.)

3741

Max. spindle speed of gear 1 (1 to 9999) [min⁻¹]

☞ Usually a voltage is output from the D/A converter by only executing an S command. However, the clockwise rotation command (M03) may be required on some machines.

- (4) If the output voltage is not correct, perform the following calculation, and change the value of parameter 3730 to adjust the gain of the D/A converter:

$$\text{Setting} = \frac{10\text{V}}{\text{Measured voltage}} \times (\text{Current value of PRM 3730})$$

- (5) Execute an S command again and confirm that the output voltage is correct.

 Restore the original parameter values.

8

TROUBLESHOOTING

This chapter describes troubleshooting procedure.

| | | |
|------|--|-----|
| 8.1 | CORRECTIVE ACTION FOR FAILURES | 455 |
| 8.2 | NO MANUAL OPERATION NOR AUTOMATIC OPERATION CAN BE EXECUTED | 457 |
| 8.3 | JOG OPERATION CANNOT BE DONE | 461 |
| 8.4 | MANUAL HANDLE OPERATION CANNOT BE DONE | 465 |
| 8.5 | AUTOMATIC OPERATION CANNOT BE DONE | 470 |
| 8.6 | CYCLE START LED SIGNAL HAS TURNED OFF | 478 |
| 8.7 | NOTHING IS DISPLAYED ON THE LCD WHEN THE POWER IS TURNED ON | 480 |
| 8.8 | INPUT FROM AND OUTPUT TO I/O DEVICES CANNOT BE PERFORMED INPUT/OUTPUT CANNOT BE PERFORMED PROPERLY | 482 |
| 8.9 | IN A CONNECTOR PANEL I/O UNIT, DATA IS INPUT TO AN UNEXPECTED ADDRESS | 484 |
| 8.10 | IN A CONNECTOR PANEL I/O UNIT, NO DATA IS OUTPUT TO AN EXPANSION UNIT | 485 |
| 8.11 | ALARM 85 TO 87 (READER/PUNCHER INTERFACE ALARM) | 486 |
| 8.12 | ALARM 90 (REFERENCE POSITION RETURN IS ABNORMAL) | 490 |
| 8.13 | ALARM 300 (REQUEST FOR REFERENCE POSITION RETURN) | 492 |
| 8.14 | ALARM 401 (V READY OFF) | 493 |
| 8.15 | ALARM 404 (V READY ON) | 495 |
| 8.16 | ALARM 462 (SEND CNC DATA FAILED) ALARM 463 (SEND SLAVE DATA FAILED) | 496 |
| 8.17 | ALARM 417 (DIGITAL SERVO SYSTEM IS ABNORMAL) | 497 |
| 8.18 | ALARM 700 (OVERHEAT: CONTROL UNIT) | 498 |
| 8.19 | ALARM 701 (OVERHEAT: FAN MOTOR) | 499 |
| 8.20 | ALARM 704 (SPINDLE SPEED FLUCTUATION DETECTION ALARM) | 500 |
| 8.21 | ALARM 749 (SERIAL SPINDLE COMMUNICATION ERROR) | 501 |
| 8.22 | ALARM 750 (SPINDLE SERIAL LINK STARTUP FAILURE) | 502 |

| | |
|---|-----|
| 8.23 ALARM 5134 (FSSB: OPEN READY TIME OUT) | |
| ALARM 5135 (FSSB: ERROR MODE) | |
| ALARM 5137 (FSSB: CONFIGURATION ERROR) | |
| ALARM 5197 (FSSB: OPEN TIME OUT) | |
| ALARM 5198 (FSSB: ID DATA NOT READ) | 504 |
| 8.24 ALARM 5136 | |
| (FSSB: NUMBER OF AMPS IS SMALL) | 506 |
| 8.25 ALARM 900 (ROM PARITY) | 507 |
| 8.26 ALARMS 912 TO 919 (DRAM PARITY) | 508 |
| 8.27 ALARM 920 (SERVO ALARMS) | 509 |
| 8.28 ALARM 926 (FSSB ALARM) | 510 |
| 8.29 ALARM 930 (CPU INTERRUPT) | 513 |
| 8.30 ALARM 935 (SRAM ECC ERROR) | 514 |
| 8.31 ALARM 950 (PMC SYSTEM ALARM) | 515 |
| 8.32 ALARM 951 (PMC WATCHDOG ALARM) | 518 |
| 8.33 ALARM 972 (NMI ALARM ON AN OPTION BOARD) (Series 0i-C ONLY) | 519 |
| 8.34 ALARM 973 (NMI ALARM WITH AN UNKNOWN CAUSE) | 520 |
| 8.35 ALARM 974 (F-BUS ERROR) | 521 |
| 8.36 ALARM 975 (BUS ERROR) | 522 |
| 8.37 ALARM 976 (LOCAL BUS ERROR) | 523 |
| 8.38 SERVO ALARMS | 524 |
| 8.39 SPC ALARMS | 527 |
| 8.40 SPINDLE ALARMS | 528 |

8.1 CORRECTIVE ACTION FOR FAILURES

When a failure occurs, it is important to correctly grasp what kind of failure occurred and take appropriate action, to promptly recover the machine.

Check for the failure according to the following procedure :

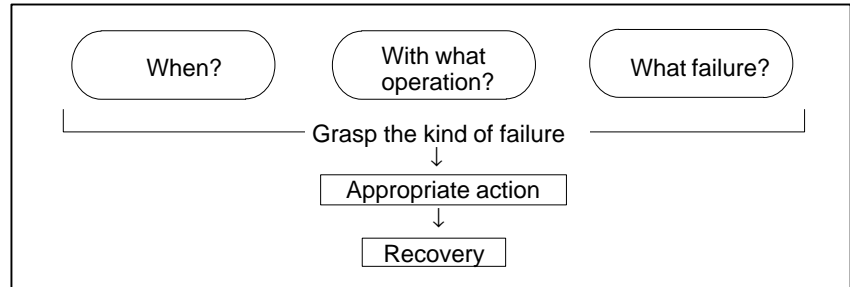

8.1.1 Investigating the Conditions Under which Failure Occurred

- (1) When and how many times (frequency of occurrences)
- (2) With what operation
- (3) What failure occurred

1 When did the failure occur?

- Date and time?
- Occurred during operation? (how long was the operation?)
- Occurred when the power was turned on?
- Was there any lightening surge, power failure, or other disturbances to the power supply?

How many times has it occurred

- Only once?
- Occurred many times ? (How many times per hour, per day, or per month?)

2 With what operation did it occur ?

- What was the NC mode when the failure occurred?
Jog mode/memory operation mode /MDI mode /reference position return mode
- If during program operation,
 - 1) Where in the program ?
 - 2) Which program No. and sequence No. ?
 - 3) What program ?
 - 4) Occurred during axial movement ?
 - 5) Occurred during the execution of an M/S/T code ?
 - 6) Failure specific to the program ?
- Does the same operation cause the same failure ?
(Check the repeatability of the failure.)
- Occurred during data input/output ?

<Feed axes and spindles>

- For a failure related to feed axis servo
 - 1) Occurred at both low feedrate and high feedrate ?
 - 2) Occurred only for a certain axis ?

- For a failure related to spindles
When did the failure occur ? (during power-on, acceleration, deceleration, or constant rotation)
- 3 What failure occurred ?
- Which alarm was displayed on the alarm display screen?
(Check the axis along which an alarm has occurred for alarms 300 to 599.)
 - Is the screen correct ?
 - If machining dimensions are incorrect
 - 1) How large is the error ?
 - 2) Is the position display on the CRT correct ?
 - 3) Are the offsets correct ?
- 4 Other information
- Is there noise origin around machine?
If the failure has not occurred frequently, the cause may be external noise to the power supply or inductive noise on machinery cables. Operate other machines connected to the same power line and see if noise come from the relays or compressors.
 - Is it taken any countermeasure for noise in machine side?
 - Check the following for the input power supply voltage :
 - 1) Is there variation in the voltage ?
 - 2) Are the voltages different depending on the phase ?
 - 3) Is the standard voltage supplied ?
 - How high is the ambient temperature of the control unit?
Refer to manual about noise.
 - Has excessive vibration been applied to the control unit?
- 5 When you contact our service center, specify the following items :
- 1) Name of the NC unit
 - 2) Name of the machine tool builder and type of machine
 - 3) Software series/version of the NC
 - 4) Specifications of the servo amplifier and motor
(for a failure related to the servo)
 - 5) Specifications of the spindle amplifier and spindle motor
(for a failure related to a spindle)
- See the drawing issued by the machine tool builder for the locations of the NC unit and servo/spindle amplifiers.
 - We use the following specification codes :
Servo /spindle amplifier : A06B-□□□□-H□□□
Servo/spindle amplifier : A06B-□□□□-B□□□

NOTE

The mark '□' represents a number.

8.2 NO MANUAL OPERATION NOR AUTOMATIC OPERATION CAN BE EXECUTED

Points

- (1) Execute the following procedure when no manual nor automatic operation is done
- (2) Check whether position display shows correct position
- (3) Check CNC status display
- (4) Check CNC internal status using diagnostic function

Causes and Countermeasures

1. Position display (relative, absolute, machine coordinate) does not change

- (1) Check CNC status display (Refer to Section 1.9 CNC STATUS DISPLAY for detail.)
 - (a) Emergency stop status (Emergency stop signal is turned on)
 If status display shows **EMG** the emergency stop signal is input. Check the following signal using the PMC's diagnostic function (PMCDGN).

| | #7 | #6 | #5 | #4 | #3 | #2 | #1 | #0 |
|-------|----|----|----|------|----|----|----|----|
| X1008 | | | | *ESP | | | | |
| G0008 | | | | *ESP | | | | |

ESP=0 indicates that emergency stop signal is input.

(b) It is a reset status

When RESET is displayed, any of a reset is functioned. Check the following signal using the PMC's diagnostic function (PMCDGN).

1) An input signal from the PMC functions

| | #7 | #6 | #5 | #4 | #3 | #2 | #1 | #0 |
|-------|-----|-----|----|----|----|----|----|----|
| G0008 | ERS | RRW | | | | | | |

When ERS is 1, external reset signal is input.

When RRW is 1, reset & rewinding signal is input.

2) RESET key on the MDI keyboard functions

When the signals in 1) are 0, **RESET** key may be functioning.

Check the contact of **RESET** key using a tester.

When it is abnormal, change the keyboard.

(c) Confirm the status of modes

Operation mode status is displayed on the lower part of CRT as follows :

If nothing is displayed, mode select signal is not input. Check mode select signal using PMC's diagnostic function (PMCDGN). For details, refer to section 1.9 CNC STATUS DISPLAY.

(Example of display)

JOG : Manual operation (JOG) mode

HND : Manual handle (MPG) mode

MDI : Manual data input (MDI) mode

MEM : Automatic operation (Memory) mode

EDIT: EDIT (Memory edit) mode

<Mode select signal>

| | | | | | | | | |
|-------|-----------------------------------|----|----|----|----|-----|-----|-----|
| G0043 | #7 | #6 | #5 | #4 | #3 | #2 | #1 | #0 |
| | | | | | | MD4 | MD2 | MD1 |
| | | | | | | ↓ | ↓ | ↓ |
| | Manual operation (JOG) mode | | | | | 1 | 0 | 1 |
| | Manual handle (MPG) mode | | | | | 1 | 0 | 0 |
| | Manual data input (MDI) mode | | | | | 0 | 0 | 0 |
| | Automatic operation (Memory) mode | | | | | 0 | 0 | 1 |
| | EDIT (Memory edit) mode | | | | | 0 | 1 | 1 |

(2) Check diagnostic data 000 to 025 of the CNC Check an item for which 1 is displayed

| No. | Message | Display |
|-------|---------------------------------|---------------|
| 000 | WAITING FOR FIN SIGNAL | : 0 |
| 001 | MOTION | : 0 |
| 002 | DWELL | : 0 |
| a.003 | IN-POSITION CHECK | : 0 |
| 004 | FEEDRATE OVERRIDE 0% | : 0 |
| b.005 | INTERLOCK / START LOCK | : 1 (Example) |
| 006 | SPINDLE SPEED ARRIVAL CHECK | : 0 |
| 010 | PUNCHING | : 0 |
| 011 | READING | : 0 |
| 012 | WAITING FOR (UN) CLAMP | : 0 |
| c.013 | JOG FEEDRATE OVERRIDE 0% | : 0 |
| d.014 | WAITING FOR RESET, ESP, RRW OFF | : 0 |
| 015 | EXTERNAL PROGRAM NUMBER SEARCH | : 0 |

Items with a to d relate with manual and automatic operation and its detail is shown below.

a. In-position check is being done

It shows that positioning is not yet completed. Check the contents of the following diagnostic number. (It is 1 in the following condition)

DGN 0300 Position Error >PARAM 1826 In-position width

1) Check the parameters according to the parameter list.

| | |
|------|--|
| 1825 | Servo loop gain per axis (Normal : 3000) |
|------|--|

2) Servo system may be abnormal. Refer to servo alarm 400, 410, and 411.

b. Interlock or start lock signal is input

There are a plural interlock signals. Check at first which interlock signal is used by the machine tool builder at the parameters shown below.

| | | | | | | | | |
|------|----|----|----|-----|-----|-----|----|-----|
| | #7 | #6 | #5 | #4 | #3 | #2 | #1 | #0 |
| 3003 | | | | DAU | DIT | ITX | | ITL |

- #0 ITL=0 shows interlock signal *IT is effective. Go to 1).
- #2 ITX=0 shows interlock signal *ITn is effective. Go to 2).
- #3 DIT=0 shows interlock signal ±MITn is effective. Go to 3).
- #4 DAU=When it is “1,” the interlock signal (±MITn) is effective even in automatic operation.
Go to 3).

Check state of effective interlock signals using the diagnostic function (PMCDGN) of the PMC.

1) Interlock signal (*IT) is input.

| | | | | | | | | |
|-------|----|----|----|----|----|----|----|-----|
| | #7 | #6 | #5 | #4 | #3 | #2 | #1 | #0 |
| G0008 | | | | | | | | *IT |

*IT=0 shows that interlock signal is input.

2) Axis interlock signal (*ITn) is input.

| | | | | | | | | |
|-------|----|----|----|----|------|------|------|------|
| | #7 | #6 | #5 | #4 | #3 | #2 | #1 | #0 |
| G0130 | | | | | *IT4 | *IT3 | *IT2 | +IT1 |

*ITn=0 shows interlock signal is input.

3) Interlock signal per axis and direction (±MITn) is input.

● M series

| | | | | | | | | |
|-------|----|----|----|----|-------|-------|-------|-------|
| | #7 | #6 | #5 | #4 | #3 | #2 | #1 | #0 |
| G0132 | | | | | +MIT4 | +MIT3 | +MIT2 | +MIT1 |

| | | | | | | | | |
|-------|----|----|----|----|-------|-------|-------|-------|
| | #7 | #6 | #5 | #4 | #3 | #2 | #1 | #0 |
| G0134 | | | | | -MIT4 | -MIT3 | -MIT2 | -MIT1 |

● T series

| | | | | | | | | |
|-------|----|----|-------|-------|-------|-------|----|----|
| | #7 | #6 | #5 | #4 | #3 | #2 | #1 | #0 |
| X0004 | | | -MIT2 | +MIT2 | -MIT1 | +MIT1 | | |

±MITn=1 shows interlock signal per axis and direction is input.

* In T series, ±MITn is effective only when the manual operation is used.

c. Jog feedrate override is 0% Check the signals using PMC's diagnostic function (PMCDGN)

| | | | | | | | | |
|-------|-------|-------|-------|-------|-------|-------|------|------|
| | #7 | #6 | #5 | #4 | #3 | #2 | #1 | #0 |
| G0010 | *JV7 | *JV6 | *JV5 | *JV4 | *JV3 | *JV2 | *JV1 | *JV0 |
| G0011 | *JV15 | *JV14 | *JV13 | *JV12 | *JV11 | *JV10 | *JV9 | *JV8 |

When the override is 0% all bits of the above address becomes 1111 1111 or 0000 0000.

| *JV15 JV0 | Override |
|---------------------|----------|
| 1111 1111 1111 1111 | 0.00% |
| 1111 1111 1111 1110 | 0.01% |
| ⋮ | ⋮ |
| 1101 1000 1110 1111 | 100.00% |
| ⋮ | ⋮ |
| 0000 0000 0000 0001 | 655.34% |
| 0000 0000 0000 0000 | 0.00% |

d. NC is in a reset state

In this case, RESET is also displayed on the status display. Check it using the procedure of b above.

2. When machine coordinate value does not update on position display

(1) Machine lock signal (MLK) is input.

| | | | | | | | | |
|-------|----|----|----|----|------|------|------|------|
| | #7 | #6 | #5 | #4 | #3 | #2 | #1 | #0 |
| G0044 | | | | | | | | MLK |
| G0108 | | | | | MLK4 | MLK3 | MLK2 | MLK1 |

MLK : All axes machine lock

MLKn : Each axis machine lock

When the signal is 1, the corresponding machine lock signal is input.

8.3 JOG OPERATION CANNOT BE DONE

Points

- (1) Check whether position display is operating.
- (2) Check CNC status display.
- (3) Check internal status using Diagnostic function.

Causes and Remedies

**1. Position display
(relative, absolute,
machine coordinate)
does not change**

- (1) Check mode selection status (JOG mode is not selected).

When status display shows JOG, it is normal.

When status display does not show JOG, mode select signal is not selected correctly. Confirm the mode select signal using PMC's diagnostic function (PMCDGN).

<Mode select signal>

| | #7 | #6 | #5 | #4 | #3 | #2 | #1 | #0 |
|-------|-----------------------------|----|----|----|----|-----|-----|-----|
| G0043 | | | | | | MD4 | MD2 | MD1 |
| | | | | | | ↓ | ↓ | ↓ |
| | Manual operation (JOG) mode | | | | | 1 | 0 | 1 |

- (2) Feed axis and direction select signal is not input Check the signal using PMC's diagnostic function (PMCDGN).

| | #7 | #6 | #5 | #4 | #3 | #2 | #1 | #0 |
|-------|----|----|----|----|-----|-----|-----|-----|
| G0100 | | | | | +J4 | +J3 | +J2 | +J1 |
| G0102 | | | | | -J4 | -J3 | -J2 | -J1 |
| G0086 | | | | | -Ja | +Ja | -Jg | +Jg |

When a bit is "1", the corresponding feed axis direction selection signal has been entered.

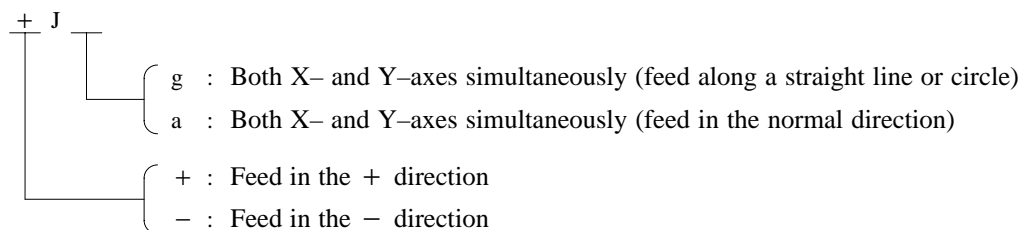

Example)

In the normal state, pressing the "+X" button on the operator's panel causes the signal +Jn to be displayed as "1".

* This signal becomes effective when the rise of the signal is detected. If, therefore, the direction selection signal has been entered before jog mode selection, axis movement is not performed; set the bit "0" and then re-check the signal.

- * By defining a straight line or arc in the CNC beforehand using the R area of the PMC, +Jg and \pm Ja allow the tool to move along both X- and Y-axes simultaneously. The exchange of information with the R area of the PMC is performed by the macro software or PMC sequence program created by the MTB.

(3) Check CNC's diagnostic function 000 to 015. Check the items for which 1 is displayed at right side.

| No. | Message | Display |
|-----|-------------------------------------|--------------|
| | 000 WAITING FOR FIN SIGNAL | : 0 |
| | 001 MOTION | : 0 |
| | 002 DWELL | : 0 |
| a. | 003 IN-POSITION CHECK | : 0 |
| | 004 FEEDRATE OVERRIDE 0% | : 0 |
| b. | 005 INTERLOCK / START LOCK | : 1(Example) |
| | 006 SPINDLE SPEED ARRIVAL CHECK | : 0 |
| | 010 PUNCHING | : 0 |
| | 011 READING | : 0 |
| | 012 WAITING FOR (UN) CLAMP | : 0 |
| c. | 013 JOG FEEDRATE OVERRIDE 0% | : 0 |
| d. | 014 WAITING FOR RESET, ESP, RRW OFF | : 0 |
| | 015 EXTERNAL PROGRAM NUMBER SEARCH | : 0 |

Items with a to d relate with manual and automatic operation and its detail is shown below.

a. In-position check is being done

It shows that positioning is not yet completed. Check the contents of the following diagnostic number. (It is 1 in the following condition)

DGN 0300 Position Error >PARAM 1826 In-positio width

1) Check the parameters according to the parameter list.

| | |
|------|--|
| 1825 | Servo loop gain per axis (Normal : 3000) |
|------|--|

2) Servo system may be abnormal. Refer to servo alarm 400, 410, and 411.

b. Interlock or start lock signal is input

There are a plural interlock signals. Check at first which interlock signal is used by the machine tool builder at the parameters shown below.

| | | | | | | | | | |
|-------|------|----|----|----|----|-----|-----|----|-----|
| | | #7 | #6 | #5 | #4 | #3 | #2 | #1 | #0 |
| PARAM | 3003 | | | | | DIT | ITX | | ITL |

#0 ITL=0 shows interlock signal *IT is effective. Go to 1).
 #2 ITX=0 shows interlock signal *ITn is effective. Go to 2).
 #3 DIT=0 shows interlock signal ± MITn is effective. Go to 3).
 Check state of effective interlock signals using the diagnostic function (PMCDGN) of the PMC.

1) Interlock signal (*IT) is input.

| | | | | | | | | | |
|-------|--|----|----|----|----|----|----|----|-----|
| | | #7 | #6 | #5 | #4 | #3 | #2 | #1 | #0 |
| G0008 | | | | | | | | | *IT |

*IT=0 shows that interlock signal is input.

2) Axis interlock signal (*ITn) is input.

| | | | | | | | | | |
|-------|--|----|----|----|----|------|------|------|------|
| | | #7 | #6 | #5 | #4 | #3 | #2 | #1 | #0 |
| G0130 | | | | | | *IT4 | *IT3 | *IT2 | +IT1 |

*ITn=0 shows interlock signal is input.

3) Interlock signal per axis and direction (± MITn) is input

· M series

| | | | | | | | | | |
|-------|--|----|----|----|----|-------|-------|-------|-------|
| | | #7 | #6 | #5 | #4 | #3 | #2 | #1 | #0 |
| G0132 | | | | | | +MIT4 | +MIT3 | +MIT2 | +MIT1 |

| | | | | | | | | | |
|-------|--|----|----|----|----|-------|-------|-------|-------|
| | | #7 | #6 | #5 | #4 | #3 | #2 | #1 | #0 |
| G0134 | | | | | | -MIT4 | -MIT3 | -MIT2 | -MIT1 |

· T series

| | | | | | | | | | |
|-------|--|----|----|-------|-------|-------|-------|----|----|
| | | #7 | #6 | #5 | #4 | #3 | #2 | #1 | #0 |
| X0004 | | | | -MIT2 | +MIT2 | -MIT1 | +MIT1 | | |

± MITn=1 shows interlock signal per axis and direction is input.

* For the T series, ± MITn is valid only for manual operation.

c. Jog feedrate override is 0% Check the signals using PMC's diagnostic function (PMCDGN)

| | | | | | | | | |
|-------|-------|-------|-------|-------|-------|-------|------|------|
| | #7 | #6 | #5 | #4 | #3 | #2 | #1 | #0 |
| G0010 | *JV7 | *JV6 | *JV5 | *JV4 | *JV3 | *JV2 | *JV1 | *JV0 |
| G0011 | *JV15 | *JV14 | *JV13 | *JV12 | *JV11 | *JV10 | *JV9 | *JV8 |

When the override is 0% all bits of the above address becomes 1111 1111 or 0000 0000.

| *JV15 JV0 | Override |
|---------------------|----------|
| 1111 1111 1111 1111 | 0.00% |
| 1111 1111 1111 1110 | 0.01% |
| ⋮ | ⋮ |
| 1101 1000 1110 1111 | 100.00% |
| ⋮ | ⋮ |
| 0000 0000 0000 0001 | 655.34% |
| 0000 0000 0000 0000 | 0.00% |

d. NC is in a reset state

In this case, RESET is also displayed on the status display. Check it using the procedure of 1 above.

(4) Jog feed rate setting (Parameter) is not correct.

| | |
|------|-----------------------|
| 1423 | Jog feedrate per axis |
|------|-----------------------|

(5) Manual feed per revolution is selected (T series)

This function feeds an axis synchronized with spindle rotation and whether this function is used or not is selected by the following parameter:

| | | | | | | | | |
|------|----|----|----|----|-----|----|----|----|
| | #7 | #6 | #5 | #4 | #3 | #2 | #1 | #0 |
| 1402 | | | | | JRV | | | |

#3 (JRV) 0 : Jog feed is of feed per minute

1 : Jog feed is of feed per revolution

(a) When parameter JRV is set to 1, feed rate of the axis is calculated by synchronizing with rotation of the spindle. Therefore, rotate the spindle.

(b) If the axis does not move even when the spindle is rotated, check the detector of the spindle (position coder) and the cable between the position coder and the CNC if it is short-circuited or ungrounded. Refer to 2.4 for connection diagram.

(6) The specified axis is the index table indexing axis. <M series>

For the index table indexing axis (B-axis), jog feed, incremental feed, and manual handle feed cannot be performed.

8.4 MANUAL HANDLE OPERATION CANNOT BE DONE

Causes and actions

If manual handle operation cannot be performed, the probable causes include the following:

- The servo is not activated.
- Manual pulse generators are not connected properly to the I/O module with the manual pulse interface.
- The I/O module with the manual pulse interface is not allocated, or is not allocated properly.
- A related input signal is not input due to a parameter setting error.

1 The servo is not activated

Check that the LED on the servo amplifier indicates “0”. If a number other than “0” is indicated, the servo is not activated. In this state, even JOG operation and automatic operation cannot be operated. Check the servo-related parameters and the wiring.

2 Checking the manual pulse generators

(1) Cable failures (such as breaks)

Examine the cables for faults such as breaks and short-circuits, referring to the figure below.

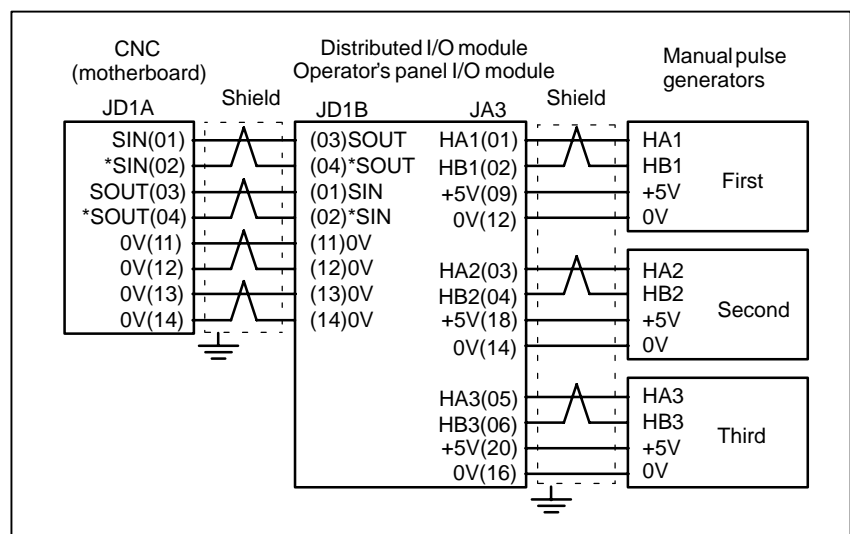
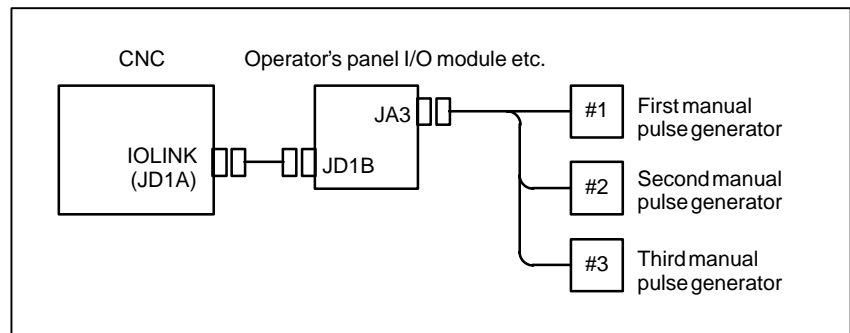

(2) Manual pulse generator failures

When rotated, a manual pulse generator generates the signals shown below. Using an oscilloscope, measure the signals from the screw terminal block located at the rear of a manual pulse generator. If no signals are output, measure the +5 V voltage.

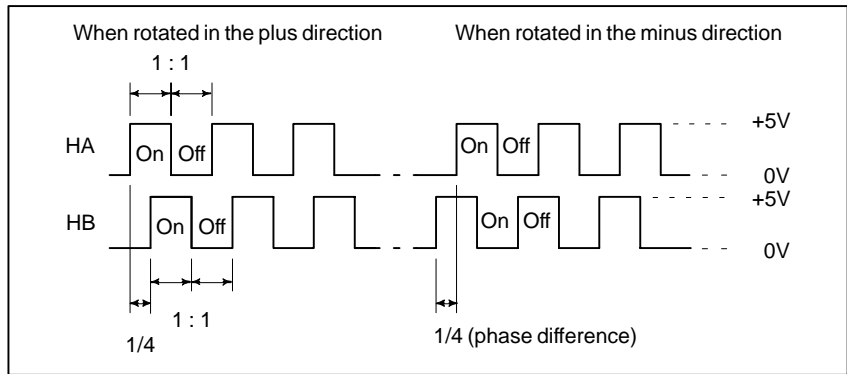
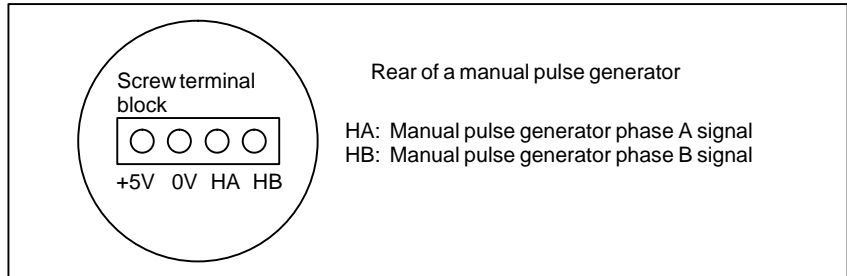

Check the on/off ratio and the phase difference between HA and HB.

3 Allocation of the I/O link of the I/O module

If the I/O module is not allocated properly in I/O link allocation, the pulses of the manual pulse generators are not transmitted to the CNC, making it impossible to perform manual handle operation.

The I/O modules to which manual pulse generators can be connected are listed below.

| Name | Specifications |
|---|----------------|
| I/O unit for 0i | A02B-0309-C001 |
| I/O module for connector panel (extended module A) | A03B-0815-C002 |
| I/O module for operator's panel (supporting matrix input) | A20B-2002-0470 |
| I/O module for operator's panel | A20B-2002-0520 |
| Main panel B of machine operator's panel | A02B-0236-0231 |
| Main panel B1 of machine operator's panel | A02B-0236-0241 |

If a multiple number of these modules are used and are allocated so that they use a manual pulse generator, the module nearest the CNC becomes effective because of the I/O link connection.

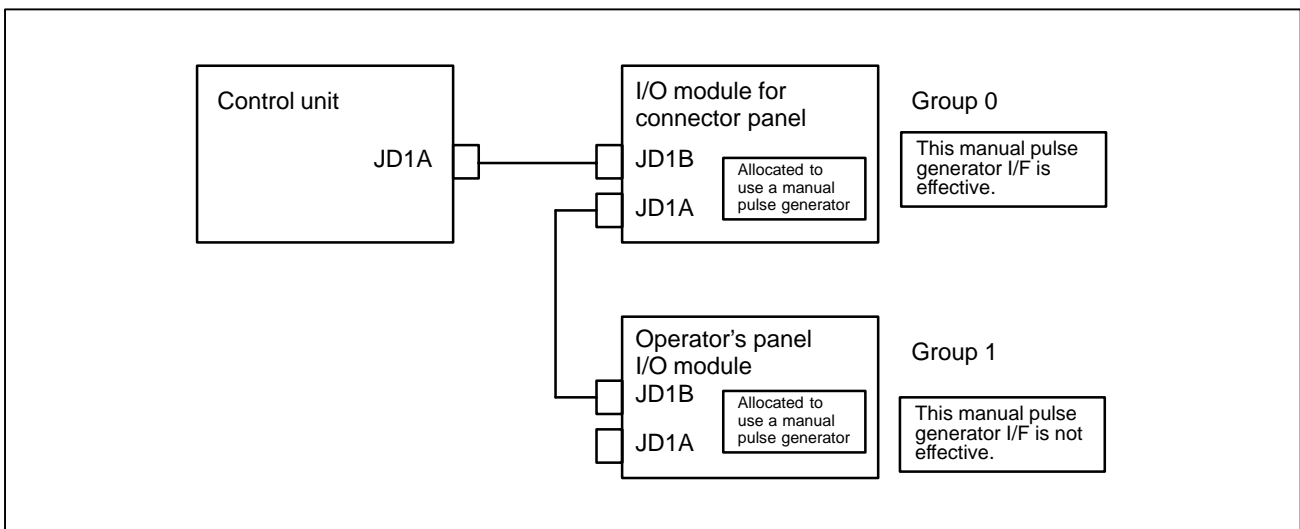

In this example, the manual pulse generator connected to the I/O module for a connector panel in group 0 is effective.

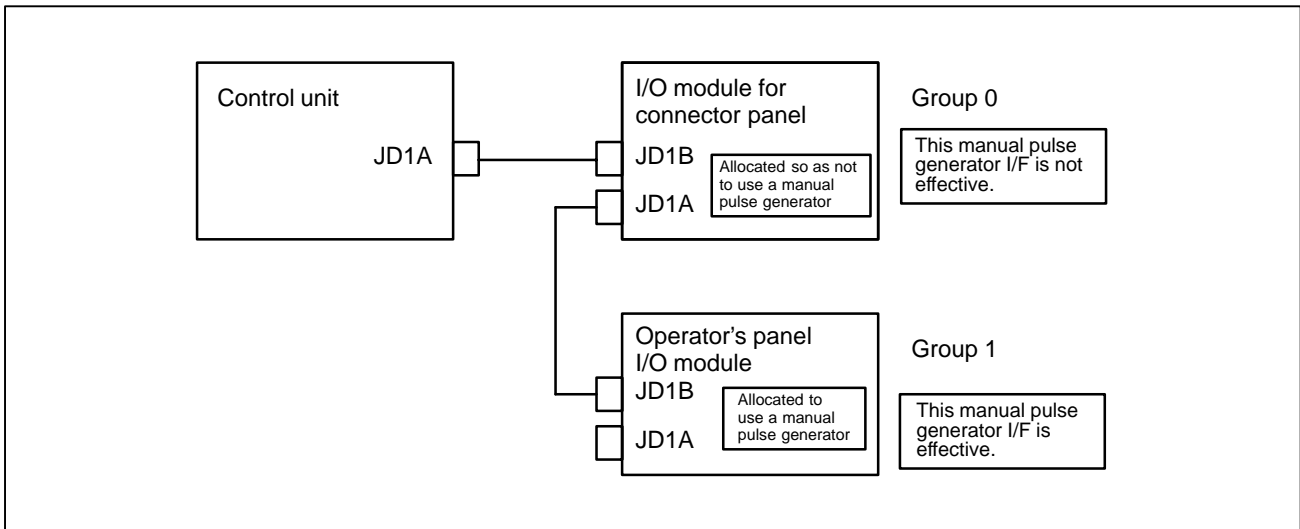

If the I/O module for a connector panel in group 0 is allocated so as not to use a manual pulse generator, as in this example, the manual pulse generator interface of the operator's panel I/O module in group 1 is effective.

The allocation can be confirmed on the allocation edit screen. Selecting [EDIT] and then [MODULE] from the PMC screen causes the allocation edit screen to be displayed.

After editing allocation, write the changes to the FROM on the [I/O] screen. Otherwise, the changes will be lost when the power is turned off. If allocation is performed properly, when a manual pulse generator is rotated, the bits count up/down in the area of the corresponding input signal (X). Select [PMCDGN] and then [STATUS] from the PMC screen to display the corresponding address, and rotate the manual pulse generator to check that the bits count up/down.

4 Checking the parameters and input signals

- (1) Check CNC status display at lower left corner of the CRT.
(See Section 1.9.)

When the status display shows HND, mode selection is correct.

If it is not HND, mode select signal is not input correctly. Check the mode select signal using the PMC's diagnostic function(PMCDGN).

| | | | | | | | | |
|--------------------|----|----|----|----|----|-----|-----|-----|
| G0043 | #7 | #6 | #5 | #4 | #3 | #2 | #1 | #0 |
| | | | | | | MD4 | MD2 | MD1 |
| | | | | | | | ↓ | ↓ |
| Manualehandle mode | | | | | | 1 | 0 | 0 |

(2) Manual handle feed axis select signal is not input.

Check the signals using PMC's diagnostic function (PMCDGN).

| | | | | | | | | |
|-------|------|------|------|------|------|------|------|------|
| | #7 | #6 | #5 | #4 | #3 | #2 | #1 | #0 |
| G0018 | HS2D | HS2C | HS2B | HS2A | HS1D | HS1C | HS1B | HS1A |
| G0019 | | | | | HS3D | HS3C | HS3B | HS3A |

When axis select switch for manual handle feed is selected on the machine operator's panel, if the signals are input as follows, it is normal.

| Selected axis | HSnD | HSnC | HSnB | HSnA |
|---------------|------|------|------|------|
| no selection | 0 | 0 | 0 | 0 |
| 1st axis | 0 | 0 | 0 | 1 |
| 2nd axis | 0 | 0 | 1 | 0 |
| 3rd axis | 0 | 0 | 1 | 1 |
| 4th axis | 0 | 1 | 0 | 0 |

NOTE

In the above table, n is the number of the manual pulse generator (MPG) and up to 3 MPGs can be used. A feed axis is selected by 4-bit code of A to D.

(3) Manual handle feed multiplication is not correct

Check the following signals using PMC's PCDGN. Also confirm the following parameters based on the parameter list.

| | | | | | | | | |
|-------|----|----|-----|-----|----|----|----|----|
| | #7 | #6 | #5 | #4 | #3 | #2 | #1 | #0 |
| G0019 | | | MP2 | MP1 | | | | |

In handle mode, the travel distance per step can be changed.

| MP2 | MP1 | Step feed | Handle feed |
|-----|-----|-----------|-------------|
| 0 | 0 | × 1 | × 1 |
| 0 | 1 | × 10 | × 10 |
| 1 | 0 | × 100 | × Mn |
| 1 | 1 | × 1000 | × Nn |

| | | | | | | | | |
|------------|----|----|----|----|----|----|----|------|
| | #7 | #6 | #5 | #4 | #3 | #2 | #1 | #0 |
| PARAM 7102 | | | | | | | | HNGx |

#0(HNGx) The direction of rotation of the manual pulse generator and the direction of the travel of the machine are:

- 0 : Same
- 1 : Opposite

| | |
|------------|--|
| PARAM 7110 | Number of manual pulse generators used (1 to 3). |
|------------|--|

(4) The specified axis is the index table indexing axis. <M series>

For the index table indexing axis (B-axis), jog feed, incremental feed, and manual handle feed cannot be performed.

8.5 AUTOMATIC OPERATION CANNOT BE DONE

Points

- (1) Check manual operation is possible.
- (2) Check the status of cycle start LED on machine operator’s manual.
- (3) Check status of CNC.

Causes and Remedies

When manual operation is either impossible, perform countermeasure, based on the previous item “Jog operation cannot be done”. Confirm that a correct mode is selected according to the mode select status of CNC status display. Also, by confirming the automatic operation status it is possible to identify cycle operation, feed hold and cycle stop state.

1. When cycle operation is not started (Cycle start LED does not light)

“*****” is displayed at status display on CRT.

- (1) Mode select signal is not correct.

When the mode select signal is input correctly, following status display is done.

MDI :Manual data input mode (MDI)

MEM :Memory operation mode

RMT :Remote operation mode

If status display does not show a correct status, check the mode signal with following diagnosis function of PMC side (PMCDGN).

| | | | | | | | | |
|-------|----|----|------|----|----|-----|-----|-----|
| | #7 | #6 | #5 | #4 | #3 | #2 | #1 | #0 |
| G0043 | | | DNCI | | | MD4 | MD2 | MD1 |

| DNCI | MD4 | MD2 | MD1 | Mode select |
|------|-----|-----|-----|------------------------|
| – | 0 | 0 | 0 | Manual data input mode |
| 0 | 0 | 0 | 1 | Memory operation mode |
| 1 | 0 | 0 | 1 | Remote operation mode |

- (2) Cycle start signal is not input

This signal turns 1 when cycle start button is pressed and turns 0 when it is released. The cycle start actuates when it changes from 1 to 0.

Check the state of the signal using PMC’s diagnostic function (PMCDGN).

| | | | | | | | | |
|-------|----|----|----|----|----|----|----|----|
| | #7 | #6 | #5 | #4 | #3 | #2 | #1 | #0 |
| G0007 | | | | | | ST | | |

#2 (ST) : Cycle start signal

- (3) Feed hold signal is input

Under normal state, the feed hold signal is 1 when the feed hold button is not pressed.

Check the state of this signal using the PMC’s diagnostic function (PMCDGN) .

| | | | | | | | | |
|-------|----|----|-----|----|----|----|----|----|
| | #7 | #6 | #5 | #4 | #3 | #2 | #1 | #0 |
| G0008 | | | *SP | | | | | |

#5 (*SP) : Feed hold signal

2. When an automatic operation is in progress (Cycle start LED is lit)

CNC's status display shows "STRT" on the CRT.

(1) Check the contents of diagnostic nos. 000 to 015.

| No. | Message | Display |
|--------|------------------------------------|--------------|
| a. 000 | WAITING FOR FIN SIGNAL | : 1(Example) |
| b. 001 | MOTION | : 0 |
| c. 002 | DWELL | : 0 |
| d. 003 | IN-POSITION CHECK | : 0 |
| e. 004 | FEEDRATE OVERRIDE 0% | : 0 |
| f. 005 | INTERLOCK / START LOCK | : 0 |
| g. 006 | SPINDLE SPEED ARRIVAL CHECK | : 0 |
| | 010 PUNCHING | : 0 |
| | 011 READING | : 0 |
| | 012 WAITING FOR (UN) CLAMP | : 0 |
| h. 013 | JOG FEEDRATE OVERRIDE 0% | : 0 |
| i. 014 | WAITING FOR RESET, ESP, RRW OFF | : 0 |
| | 015 EXTERNAL PROGRAM NUMBER SEARCH | : 0 |

Items with a to i relate with an automatic operation and their details are as follows :

a. An auxiliary function is being executed (waiting for FIN signal)

An auxiliary function (M/S/T/B) specified in a program is not ended. Check according to the following procedure.

First, check the parameter setting to confirm the type of the interface of the auxiliary function.

| | | | | | | | | |
|------|------|----|----|----|----|----|----|----|
| | #7 | #6 | #5 | #4 | #3 | #2 | #1 | #0 |
| 3001 | HSIF | | | | | | | |

#7(HSIF) 0 : M/S/T/B is of normal interface.

1 : M/S/T/B is of high-speed interface.

1) Normal interface

When the auxiliary function finish signal turns from 1 to 0, the auxiliary function is supposed to be ended and the next block is read for operation. Confirm the status of this signal using PMC's diagnostic function (PMCDGN).

| | | | | | | | | |
|-------|----|----|----|----|-----|----|----|----|
| | #7 | #6 | #5 | #4 | #3 | #2 | #1 | #0 |
| G0004 | | | | | FIN | | | |

#3 (FIN) : Auxiliary function finish signal

2) High-speed interface

The auxiliary function is supposed to be ended when the signals are in the following state. Confirm it using PMC's diagnostic function (PMCDGN).

<M series>

| | #7 | #6 | #5 | #4 | #3 | #2 | #1 | #0 |
|-------|------|----|----|----|------|------|----|------|
| G0005 | BFIN | | | | TFIN | SFIN | | MFIN |

- #0(MFIN) : M function finish signal
- #2(SFIN) : S function finish signal
- #3(TFIN) : T function finish signal
- #4(BFIN) : 2nd auxiliary function finish signal

| | #7 | #6 | #5 | #4 | #3 | #2 | #1 | #0 |
|-------|----|----|----|----|----|----|----|----|
| F0007 | BF | | | | TF | SF | | MF |

- #0(MF) : M function strobe signal
- #2(SF) : S function strobe signal
- #3(TF) : T function strobe signal
- #7(BF) : 2nd auxiliary function strobe signal

<T series>

| | #7 | #6 | #5 | #4 | #3 | #2 | #1 | #0 |
|-------|----|----|----|------|------|------|----|------|
| G0005 | | | | BFIN | TFIN | SFIN | | MFIN |

- #0(MFIN) : M function completion signal
- #2(SFIN) : S function completion signal
- #3(TFIN) : T function completion signal
- #4(BFIN) : Second auxiliary function completion signal

| | #7 | #6 | #5 | #4 | #3 | #2 | #1 | #0 |
|-------|----|----|----|----|----|----|----|----|
| F0007 | | | | BF | TF | SF | | MF |

- #0(MF) : M function strobe signal
- #2(SF) : S function strobe signal
- #3(TF) : T function strobe signal
- #4(BF) : Second auxiliary function strobe signal

<M/T series>

| | #7 | #6 | #5 | #4 | #3 | #2 | #1 | #0 |
|-------|----|----|-------|-------|----|----|----|----|
| G0004 | | | MFIN3 | MFIN2 | | | | |

- #4(MFIN2) : Second M function completion signal
- #5(MFIN3) : Third M function completion signal

| | #7 | #6 | #5 | #4 | #3 | #2 | #1 | #0 |
|-------|----|----|-----|-----|----|----|----|----|
| F0008 | | | MF3 | MF2 | | | | |

- #4(MF2) : Second M function strobe signal
- #5(MF3) : Third M function strobe signal

* The second and third M functions are enabled only when bit 7 (M3B) of parameter No. 3404 is set to 1.

| Signal | End state | |
|---------------|-----------|---|
| Finish signal | 0 | 1 |
| store signal | 0 | 1 |

b. Travel command is being executed

CNC is reading an axis command (X,Y,Z,...) in a program and giving the command to the axis.

c. A dwell command is being executed

CNC is reading a dwell command (G04) in a program and is executing the dwell command.

d. In-position check (confirming positioning) is being done

Positioning (G00) to a specified position of a specified axis is not completed.

Whether positioning is completed or not is checked as the servo position error amount. Check it CNC's diagnostic function as follows:

$$\text{DGN no.300} \quad \boxed{\text{Position Error}} > \text{PARAM 1826} \quad \boxed{\text{In-position width}}$$

Position error amount almost becomes 0, when positioning of an axis completes and when the amount becomes within the in-position width, it is assumed that positioning completes and the next block is executed. If position error amount does not become within the in-position width, refer to servo alarm 400, 4n0 and 4n1.

e. Feedrate override is at 0%

Actual feedrate is overridden by the override signals to a programmed feedrate. Check the override signals using the PMC's diagnostic function (PMCDGN).

<Normal override signal>

| | #7 | #6 | #5 | #4 | #3 | #2 | #1 | #0 |
|-------|------|------|------|------|------|------|------|------|
| G0012 | *FV7 | *FV6 | *FV5 | *FV4 | *FV3 | *FV2 | *FV1 | *FV0 |

*FVn :Feedrate override

<2nd override signal (option)>

Feed rate is overridden more finely using the signals below:
See MTB's manual whether this feature is equipped.

| | #7 | #6 | #5 | #4 | #3 | #2 | #1 | #0 |
|-------|-------|-------|-------|-------|-------|-------|-------|-------|
| G0013 | *AFV7 | *AFV6 | *AFV5 | *AFV4 | *AFV3 | *AFV2 | *AFV1 | *AFV0 |

*AFVn :2nd feed rate override

<State of override signal>

| *FV7.....*FV0 | | *AFV7.....*AFV0 | |
|-----------------|------|-----------------|------|
| 1 1 1 1 1 1 1 1 | 0% | 1 1 1 1 1 1 1 1 | 0% |
| 1 1 1 1 1 1 1 0 | 1% | 1 1 1 1 1 1 1 0 | 1% |
| : | : | : | : |
| 1 0 0 1 1 0 1 1 | 100% | 1 0 0 1 1 0 1 1 | 100% |
| : | : | : | : |
| 0 0 0 0 0 0 0 1 | 254% | 0 0 0 0 0 0 0 1 | 254% |
| 0 0 0 0 0 0 0 0 | 0% | 0 0 0 0 0 0 0 0 | 0% |

f. Interlock signal or start lock signal is input

<T series only>

Start lock signal is input

| | #7 | #6 | #5 | #4 | #3 | #2 | #1 | #0 |
|-------|----|----|----|----|----|----|------|----|
| G0007 | | | | | | | STLK | |

#1 (STLK) With this signal being 1, start lock signal is input.

<Common to T series and M series>

There are a plural number of interlock functions. Parameters are set by machine tool builders for which interlock function is used.

Therefore, confirm the following parameters at first:

| | #7 | #6 | #5 | #4 | #3 | #2 | #1 | #0 |
|------|----|----|----|-----|-----|-----|----|-----|
| 3003 | | | | DAU | DIT | ITX | | ITL |

#0 (ITL) 0 : Interlock signal(*IT) is valid.

#2 (ITX) 0 : Interlock signal (*ITn) is valid.

#3 (DIT) 0 : Interlock signal (\pm MITn) is valid.

#4 (DAU) 1 : Interlock signal (\pm MITn) is valid in both manual operation and automatic operation.

Confirm which interlock signal is activated by the PMC's diagnostic function (PMCDGN) .

1) Interlock signal (*IT) is input

| | #7 | #6 | #5 | #4 | #3 | #2 | #1 | #0 |
|-------|----|----|----|----|----|----|----|-----|
| G0008 | | | | | | | | *IT |

#0 (*IT) : When this bit is 0, interlock signal is input.

2) Interlock signal per each axis (*ITn) is input

| | #7 | #6 | #5 | #4 | #3 | #2 | #1 | #0 |
|-------|----|----|----|----|------|------|------|------|
| G0130 | | | | | *IT4 | *IT3 | *IT2 | *IT1 |

***ITn** When the bit is 0, the corresponding axis's interlock signal is input.

3) Interlock signal per axis and direction(\pm MITn) is input

· M series

| | #7 | #6 | #5 | #4 | #3 | #2 | #1 | #0 |
|-------|----|----|----|----|-------|-------|-------|-------|
| G0132 | | | | | +MIT4 | +MIT3 | +MIT2 | +MIT1 |

| | | | | | | | | |
|-------|--|--|--|--|-------|-------|-------|-------|
| | | | | | | ↓ | ↓ | ↓ |
| G0134 | | | | | -MIT4 | -MIT3 | -MIT2 | -MIT1 |

· T series

| | #7 | #6 | #5 | #4 | #3 | #2 | #1 | #0 |
|-------|----|----|-------|-------|-------|-------|----|----|
| X0004 | | | -MIT2 | +MIT2 | -MIT1 | +MIT1 | | |

\pm MITn=1 shows interlock signal per axis and direction is input.

* For the T series, \pm MITn is valid only for manual operation.

4) Controlled axis detach function is running. A detached axis is specified for travelling.

*This function is valid when CNC parameter No.1005#7=1. For whether this function is running or not, confirm the following signal using PMC's diagnostic function (PMCDGN). Check the axis concerned.

| | | | | | | | | |
|-------|----|----|----|----|--------|--------|--------|--------|
| | #7 | #6 | #5 | #4 | #3 | #2 | #1 | #0 |
| F0110 | | | | | MDTCH4 | MDTCH3 | MDTCH2 | MDTCH1 |

When signal MDTHn is “1”, the axis detach function is in valid.
 The control axis detach function becomes valid by the following signal issued from the PMC or a CNC side parameter. Check as in the following procedure :

1) The control axis detach signal (DTCHn) is input.

| | | | | | | | | |
|-------|----|----|----|----|-------|-------|-------|-------|
| | #7 | #6 | #5 | #4 | #3 | #2 | #1 | #0 |
| G0124 | | | | | DTCH4 | DTCH3 | DTCH2 | DTCH1 |

If it is 1, the corresponding axis is detached.

2) The following parameter enables the control axis detach function to the corresponding axis.

| | | | | | | | | |
|------|------|----|----|----|----|----|----|----|
| | #7 | #6 | #5 | #4 | #3 | #2 | #1 | #0 |
| 0012 | RMVx | | | | | | | |

#7(RMVx)0 : Controlled axis is connected

1 : Controlled axis is detached

g. CNC is waiting for spindle speed arrival signal to be input

Actual spindle speed does not arrive at a speed specified in a program. Confirm the signal state using the PMC’s diagnostic function (PMCDGN).

| | | | | | | | | |
|-------|----|----|----|-----|----|----|----|----|
| | #7 | #6 | #5 | #4 | #3 | #2 | #1 | #0 |
| G0029 | | | | SAR | | | | |

#4(SAR) : When this signal is 0, spindle speed does not arrive at the specified speed.

This function is valid when PARAM 3708#0=1.

h. Manual feedrate override is 0% (dry run)

Normally manual feedrate override function is used for jog feed. But when DRN(dry run) signal turns on during an automatic operation, override values set with these signals become valid to the following speed set by a parameter.

| | | | | | | | | |
|-------|-----|----|----|----|----|----|----|----|
| | #7 | #6 | #5 | #4 | #3 | #2 | #1 | #0 |
| G0046 | DRN | | | | | | | |

#7(DRN) : Dry run signal is input with this signal being 1.

| | | | | | | | | |
|------|--------------|--|--|--|--|--|--|--|
| 1410 | Dry run rate | | | | | | | |
|------|--------------|--|--|--|--|--|--|--|

The rate when the following override value is 100%.

| | | | | | | | | |
|-------|------|------|------|------|------|------|------|------|
| | #7 | #6 | #5 | #4 | #3 | #2 | #1 | #0 |
| G0010 | *JV7 | *JV6 | *JV5 | *JV4 | +JV3 | *JV2 | *JV1 | *JV0 |

| | | | | | | | | |
|-------|-------|-------|-------|-------|-------|-------|------|------|
| G0011 | *JV15 | *JV14 | *JV13 | *JV12 | +JV11 | *JV10 | *JV9 | *JV8 |
|-------|-------|-------|-------|-------|-------|-------|------|------|

When override value is 0%, all bits of the above address is [1111 ... 1111] or [0000 ... 0000].

| *JV15 JV0 | Override |
|---------------------|----------|
| 1111 1111 1111 1111 | 0.00% |
| 1111 1111 1111 1110 | 0.01% |
| ⋮ | ⋮ |
| 1101 1000 1110 1111 | 100.00% |
| ⋮ | ⋮ |
| 0000 0000 0000 0001 | 655.34% |
| 0000 0000 0000 0000 | 0.00% |

i. NC is in a reset state

In this case, the CNC's status display shows RESET. Refer to item 1.

(2) Only rapid traverse in positioning (G00) does not function Confirm the following parameter and signals from the PMC.

(a) Setting value of rapid traverse rate

| | |
|------|------------------------------|
| 1420 | Rapid traverse rate per axis |
|------|------------------------------|

(b) Rapid traverse override signals

| | #7 | #6 | #5 | #4 | #3 | #2 | #1 | #0 |
|-------|------|--------|--------|--------|--------|--------|--------|--------|
| G0014 | | | | | | | ROV2 | ROV1 |
| G0096 | HROV | *HROV6 | *HROV5 | *HROV4 | *HROV3 | *HROV2 | *HROV1 | *HROV0 |

(HROV=0)
(HROV=1)

| ROV1 | ROV2 | Override | *HROV6 | *HROV0 | Override |
|------|------|----------|---------------|--------|----------|
| 0 | 0 | 100% | 1 1 1 1 1 1 1 | 1 | 0% |
| 1 | 1 | 50% | 1 1 1 1 1 1 0 | 0 | 1% |
| 0 | 1 | 25% | ⋮ | ⋮ | ⋮ |
| 1 | 1 | Fo | 0 0 1 1 0 1 1 | 1 | 100% |

| | |
|------|---------------------------------|
| 1421 | Rapid traverse override F0 rate |
|------|---------------------------------|

(3) Only feed (other than G00) does not function

(a) Maximum feedrate set by parameter is incorrect.

| | |
|------|-----------------|
| 1422 | Maximumfeedrate |
|------|-----------------|

Feedrate is clamped at this upper feedrate.

(b) Feedrate is specified by feed per revolution (mm/rev)

1) Position coder does not rotate

Check the connection between spindle and position coder

The following failure is considered:

- Timing belt is broken
- Key is removed
- Coupling is loose
- Connector of signal cable is loosened

2) Position coder is faulty

(c) Thread cutting does not operate

1) Position coder does not rotate

Check the connection between spindle and position coder
The following failure is considered:

- Timing belt is broken
- Key is removed
- Coupling is loose
- Connector of signal cable is loosened

2) Position coder is faulty

Position coder is connected to the spindle amplifier when serial interface spindle is used or connected to the CNC when analog interface spindle is used.

For details of connection, refer to the following.

<T series>

Whether A/B phase signals from the position coder are read correctly, can be judged also by the spindle speed display on the CRT screen (position screen). (However, it is not displayed when PARAM 3105#2=0).

<spindle amplifier>

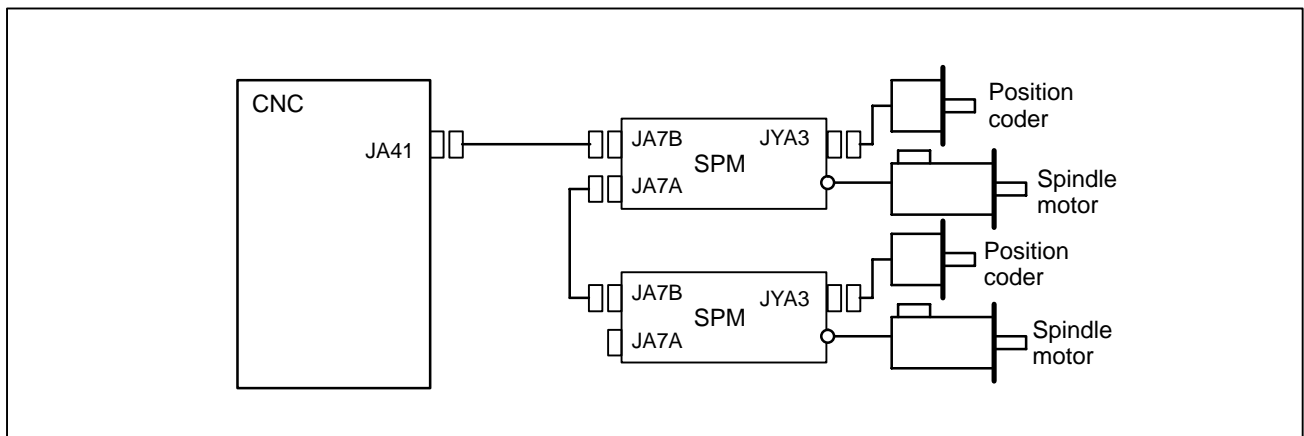

<Analog interface spindle amplifier>

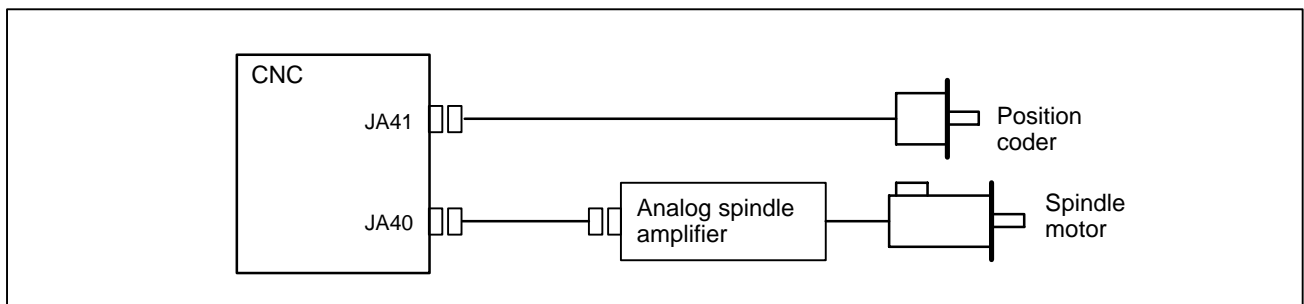

(d) A cutting feed block containing a feedrate command (F command) with a feedrate of 0 is specified.

If FCO (bit 7 of parameter No. 1404) is set to 1, P/S alarm 11 is not issued even if a feedrate command (F command) with a feedrate of 0 is issued.

8.6 CYCLE START LED SIGNAL HAS TURNED OFF

Points

- (1) After cycle operation is started, then stopped, check as follows:
- (2) Confirm cycle start LED on machine operator's panel.
- (3) Confirm CNC's diagnostic function.

Causes and Remedies

The reason why cycle start LED signal (STL) has turned off are displayed on CNC's diagnostic numbers 020 to 025 as follows:

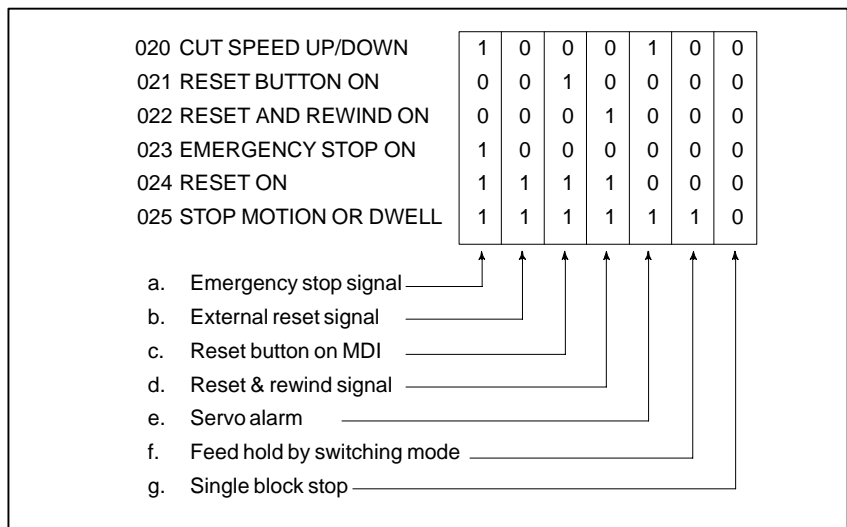

Details of signals a to g are as follows:

Confirm the signals concerned using diagnostic function (PMCDGN).

a. Emergency stop is input

| | | | | | | | | |
|-------|----|----|----|------|----|----|----|----|
| | #7 | #6 | #5 | #4 | #3 | #2 | #1 | #0 |
| X1008 | | | | *ESP | | | | |
| | #7 | #6 | #5 | #4 | #3 | #2 | #1 | #0 |
| G0008 | | | | *ESP | | | | |

*ESP=0 : Emergency stop signal is input :

b. External reset signal is input

| | | | | | | | | |
|-------|-----|----|----|----|----|----|----|----|
| | #7 | #6 | #5 | #4 | #3 | #2 | #1 | #0 |
| G0008 | ERS | | | | | | | |

#7(ERS) : When the bit is 1, external reset signal is input.

This signal is usually used for a confirmation signal of M02 when an M02 is specified in a program as the end of a program. Therefore, when M02 is executed, this signal is input.

c. Reset button on the MDI is pressed

An automatic operation is put into a reset status when RESET key on the MDI panel is pressed.

d. Reset & rewind signal is input

| | | | | | | | | |
|-------|----|-----|----|----|----|----|----|----|
| | #7 | #6 | #5 | #4 | #3 | #2 | #1 | #0 |
| G0008 | | RRW | | | | | | |

#6(RRW) : When this signal is 1, the reset & rewind signal is input.

This signal is usually used for a confirmation signal of M30 when an M30 is specified in a program as the end of a program. Therefore, when M30 is executed, this signal is input.

e. Servo alarm has generated

When any servo alarm has generated, cycle operation is put into the reset state and operation stop.

f. Cycle operation is in a feed hold state

The cycle operation becomes feed hold state in the following cases:

- 1) Modes are switched from an automatic operation mode to a manual operation mode.
- 2) Feed hold signal is input.

<Mode select signal>

| | | | | | | | | |
|-------|----|----|----|----|----|-----|-----|-----|
| | #7 | #6 | #5 | #4 | #3 | #2 | #1 | #0 |
| G0043 | | | | | | MD4 | MD2 | MD1 |
| | | | | | | ↓ | ↓ | ↓ |

| | | | | |
|---------------------|---------------------------|---|---|---|
| Automatic operation | memory edit(EDIT) | 0 | 1 | 1 |
| | Automatic operation (MEM) | 0 | 0 | 1 |
| | Manual data input (MDI) | 0 | 0 | 0 |
| Manual operation | Jog feed (JOG) | 1 | 0 | 0 |
| | Handle/step | 1 | 0 | 1 |
| | TEACH IN HANDLE | 1 | 1 | 1 |
| | TEACH IN JOG | 1 | 1 | 0 |

<Feed hold signal>

| | | | | | | | | |
|-------|----|----|-----|----|----|----|----|----|
| | #7 | #6 | #5 | #4 | #3 | #2 | #1 | #0 |
| G0008 | | | *SP | | | | | |

#5(*SP) : When this signal is 0, the feed hold signal is input.

g. It become single block stop during automatic operation

| | | | | | | | | |
|-------|----|----|----|----|----|----|-----|----|
| | #7 | #6 | #5 | #4 | #3 | #2 | #1 | #0 |
| G0046 | | | | | | | SBK | |

#1(SBK) When this signal is 1, the single block signal is input.

8.7 NOTHING IS DISPLAYED ON THE LCD WHEN THE POWER IS TURNED ON

Causes and actions

If nothing is displayed on the LCD at power-up or if the LCD is locked with “GRAPHIC IS READY.” or the slot status screen displayed, the probable causes include the following:

- The LCD cable or backlight cable is not connected.
- The necessary software is not installed.
- The main board, display control card, CPU card, or inverter board is defective.

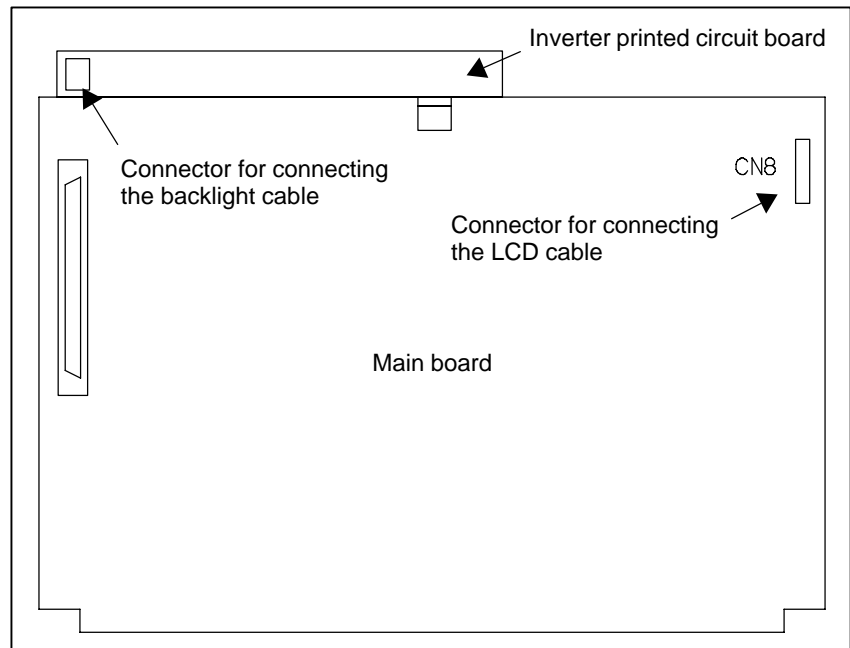

NOTE

The MDI block is left out from the drawing.

- **LED display**

Referring to the hardware chapter, check the LED on/off status of the motherboard.

If the main board has started up normally and the LED display indicates normal operation, a probable cause is a fault of the display system, such as a cable not connected or a defective inverter board.

If the LED display is locked in the middle of the startup process, the probable causes include defective hardware (or installation failure) and the necessary software not installed.

- **Connection of the LCD and backlight cables**

Check that the LCD and backlight cables are connected firmly to the corresponding connectors.

These cables are connected before shipment from FANUC. This check is, however, required because the cables may be disconnected during maintenance.

- **The necessary software is not installed**

If necessary software is not stored in the FROM module, the CNC may not start up.

- **Defective printed circuit board**

If the drawing number of the basic unit is A02B-0309-B50n, A02B-0311-B50n, or A02B-0311-B51n (where n is 0, 1, ..., 9)

If the main board or display control card is defective or not correctly installed, the CNC may not start up.

Check that the card PCBs are engaged firmly with the connectors on the main board.

If the above action does not solve the problem, replace the following:

Display control card, CPU card, and main board

See Section 2.4, "CONNECTOR AND CARD CONFIGURATIONS OF PRINTED CIRCUIT BOARDS" for an explanation of the mounting locations of the cards.

If the drawing number of the basic unit is A02B-0309-B52n, A02B-0311-B52n, or A02B-0311-B53n (where n is 0, 1, ..., 9)

The main board or axis control card may be defective or not correctly installed.

Check that the card PCBs are engaged firmly with the connectors on the main board.

If the above action does not solve the problem, replace the following:

Axis control card and main board

See Section 2.4, "CONNECTOR AND CARD CONFIGURATIONS OF PRINTED CIRCUIT BOARDS" for an explanation of the mounting locations of the cards.

8.8 INPUT FROM AND OUTPUT TO I/O DEVICES CANNOT BE PERFORMED INPUT/OUTPUT CANNOT BE PERFORMED PROPERLY

Causes and actions

- **PMC alarm NO I/O DEVICE**
- **IOCHK screen of the PMC**

If the I/O Link is not established, if the signals from an I/O device cannot be input normally to the CNC, or if the signals from the CNC cannot be output to an I/O device, the probable causes include the following:

- The I/O device is not turned on, or the power supply is not at the appropriate voltage.
- The I/O Link cable is not connected correctly or appropriately.
- The input/output signals are not connected correctly.
- I/O Link allocation is not performed, or is not performed properly.

If “NO I/O DEVICE” is displayed on the alarm screen of the PMC, no I/O devices are recognized.

By selecting [PMCDGN], [IOCHK], and [IOLNK] in this order from the PMC screen, the I/O devices recognized by the CNC are displayed. From this screen, the devices that are connected normally can be determined.

Screen display example

| GROUP | ID | KIND OF UNIT00 |
|-------|----|----------------|
| 00 | A9 | I/O MODULE01 |
| 01 | A8 | OTHER UNIT |

This example indicates that the I/O Link is as shown in the figure below.

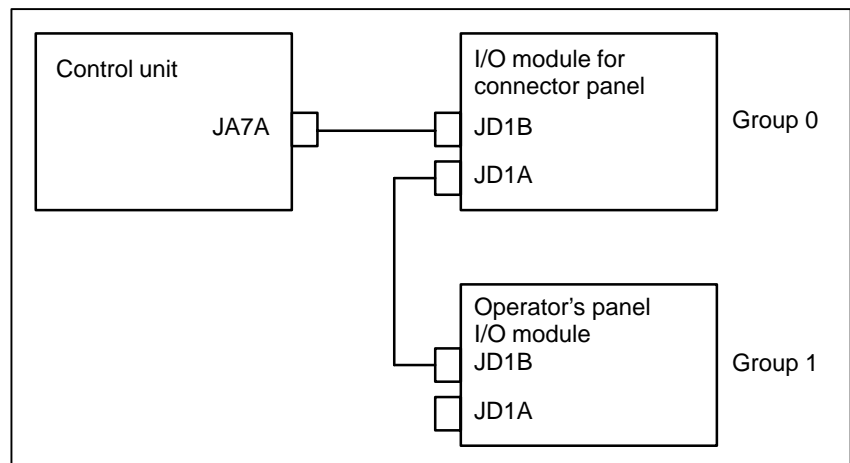

- **Checking the power supplies of the I/O devices**

Check that the connected I/O devices are connected properly to the power supplies and that the voltages are as prescribed.
Check that the power-on sequence is correct.

Time at which an I/O device is to be turned on
Before the CNC is turned on or within 500 ms after the CNC is turned on

When the CNC is turned off, the I/O devices must also be turned off. (Otherwise, the I/O Link may not be established the next time the CNC is turned on.)
- **Connection of cables**

As in the example shown on the previous page, I/O Link cables are used to connect JD1As and JD1Bs.
JD1A represents an upper unit while JD1B represents a lower unit.
Check that the cables are connected correctly.
- **Connection of I/O signals**

Check that the input/output signals to be connected to each I/O device are connected correctly.
For operator's panel I/O modules and for connector panel I/O modules, also check that the 0 V or +24 V input signal is connected to the common pin and that the +24 V output signal is connected to the DO common pin.
- **I/O Link allocation**

Check that I/O Link allocation has been performed correctly.
Selecting [EDIT] and then [MODULE] from the PMC screen causes the allocation edit screen to be displayed.
After editing allocation, write the changes to the FROM on the [I/O] screen. Otherwise, the changes will be lost when the power is turned off.
The checking of allocation requires a Ladder editing card.

8.9 IN A CONNECTOR PANEL I/O UNIT, DATA IS INPUT TO AN UNEXPECTED ADDRESS

If data is input to an invalid address in a connector panel I/O unit (for example, data that should be input to X004 is actually input to X010 in a connector panel I/O unit), the most likely causes are as follows:

(1) The I/O Link allocation is wrong.

→ Perform the check described in Section 7.4.

(2) The unit-to-unit cables (CA52-to-CA53) are not connected correctly.

If the connection is wrong, expansion unit 1 is allocated the address of expansion unit 3, as shown below.

→ Connect the unit-to-unit cables as shown below:

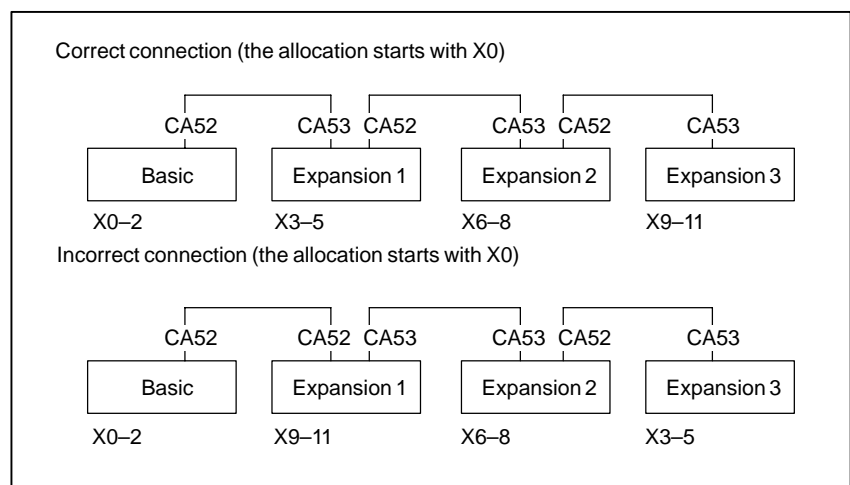

(3) The setting of the rotary switch on an expansion unit is wrong

If the rotary switch is set to 1, one unit number is skipped. If set to 2, two unit numbers are skipped. Usually, the setting must be 0. (For those units without a rotary switch, unit numbers cannot be skipped.)

→ See the following example and refer to the “FANUC Series 0i-B/0i Mate-B Connection Manual (Hardware)” (B-64113EN).

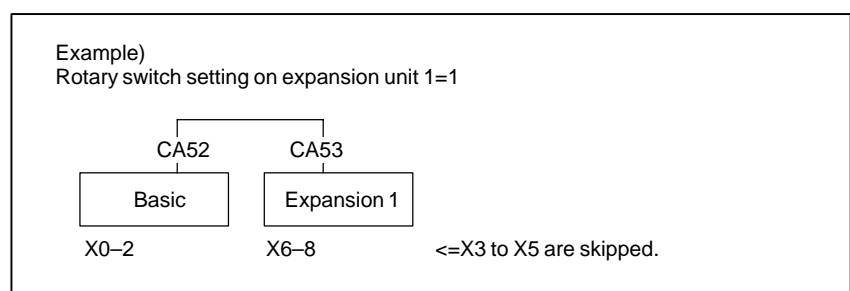

8.10 IN A CONNECTOR PANEL I/O UNIT, NO DATA IS OUTPUT TO AN EXPANSION UNIT

The most likely cause is that power is not being supplied to the expansion unit.

- Check whether 24-V power is supplied to 18P and 50P of the expansion unit, DI and DO signals are not input and output.
- Check whether 24-V power is supplied to 1P and 3P of the expansion unit, when DI signals are input and DO signals are not output.

8.11 ALARM 85 TO 87 (READER/PUNCHER INTERFACE ALARM)

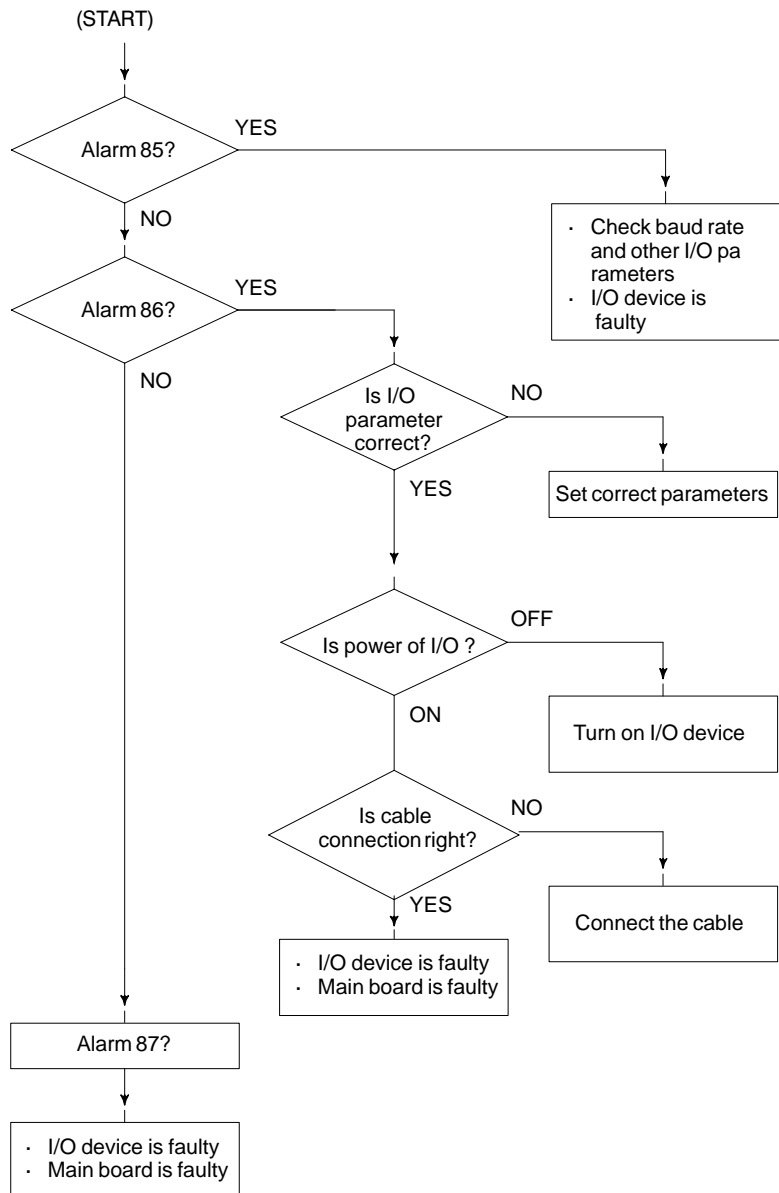

Causes

- (a) Parameters on reader/puncher interface are not correct.
Check the following setting data and parameters.
- (b) External I/O device or host computer is faulty.
- (c) Main board or serial communication board is faulty.
- (d) Cable between NC and I/O device is faulty.

Countermeasures

- (a) Parameters on reader/puncher interface are not correct.
Check the following setting data and parameters:
<Setting>
PUNCH CODE=0 OR 1 (0: EIA,1:ISO)
Select ISO or EIA according to the type of I/O device.
If punch code does not match, alarm 86 will generate.

<Parameter>

| Value of parameter 0020 Function | | 0 | 1 | 2 |
|-------------------------------------|--------|------------|--------|--------|
| | | Feed | 0101#7 | 0111#7 |
| Data input code | 0101#3 | 0111#3 | 0121#3 | |
| Stop bit | 0101#0 | 0111#0 | 0121#0 | |
| Type of I/O device | 102 | 112 | 122 | |
| Baud rate | 103 | 113 | 123 | |
| Communication method | 0135#3 | - | - | - |
| | | RS-232-C | | |
| Connector | | MAIN BOARD | | |
| | | JD5A | JD5B | |

NOTE

Numbers in the table indicate parameters and bit numbers.
Example) 101#7: bit7 of parameter 101.

| | #7 | #6 | #5 | #4 | #3 | #2 | #1 | #0 |
|------|-----|----|----|----|-----|----|----|-----|
| 0101 | NFD | | | | ASI | | | SB2 |
| 0111 | | | | | | | | |
| 0121 | | | | | | | | |
| 0131 | | | | | | | | |

#7(NFD) 0 : Feed is output before and after data in data output (FANUC PPR)
1 : Feed is not output (standard).

#3(ASI) 0 : Data input code is EIA or ISO (automatic recognition)
1 : Data input code is ASCII.

#0(SB2) 0 : No. of stop bits is 1.
1 : No. of stop bits is 2.

| | |
|------|--------------------|
| 0102 | Type of I/O device |
| 0112 | |
| 0122 | |
| 0132 | |

| Value | TYPE OF I/O DEVICE |
|-------|---|
| 0 | RS-232-C (if the following units are not used) |
| 1 | FANUC CASSETTE B1/B2 (bubble cassette) |
| 2 | FANUC CASSETTE F1 (Old type FLOPPY CASSETTE ADAPTOR) |
| 3 | FANUC Handy File |
| 4 | Not used |
| 5 | Portable tape reader |
| 6 | FANUC PPR, FANUC SYSTEM P-MODEL G, FANUC SYSTEM P-MODEL H |

| | | |
|------|-----------|--|
| 0103 | Baud rete | |
| 0113 | | |
| 0123 | | |
| 0133 | | |

| Value | Baud rate | 10 | 4800 |
|-------|-----------|----|-------|
| 7 | 600 | 11 | 9600 |
| 8 | 1200 | 12 | 19200 |
| 9 | 2400 | | |

When bit#3 of parameter no. 0135=1 (RS-422 interface), the following setting is also available.

| Value | Baud rate |
|-------|-----------|
| 13 | 38400 |
| 14 | 76800 |
| 15 | 86400 |

- (b) External I/O device or Host computer is in trouble
 - (i) Check whether the setting on communication of external I/O device or host computer is the same as that of the CNC. (baud rate, stop bits, etc.) If they are not the same, change the setting.
 - (ii) When spare I/O device presents, check whether it is possible to realize communication using the spare I/O device.

(c) Main board is faulty

(d) Cable between NC and I/O device is faulty.

Check the cable for disconnection or wrong connection.

<Connection>

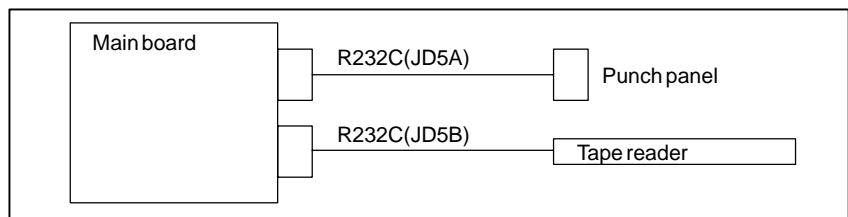

< Cable connection >

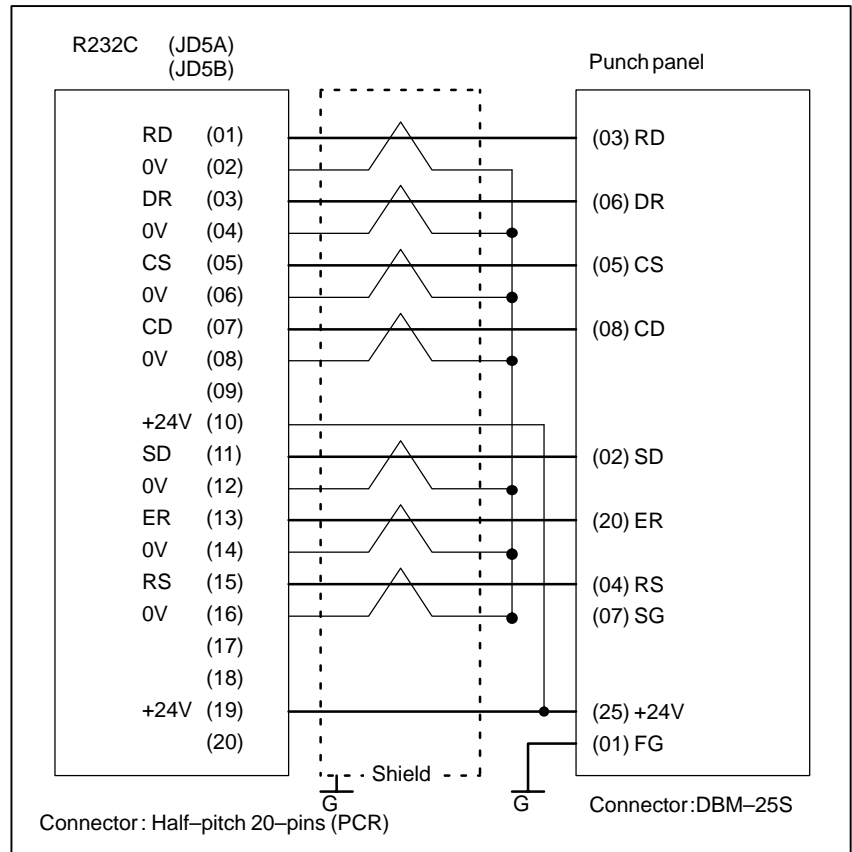

8.12 ALARM 90 (REFERENCE POSITION RETURN IS ABNORMAL)

Contents

Reference position return was executed when the following condition is not satisfied:

The CNC received one rotation signal at least one time when the axis is moving to the reference position at a speed higher than a speed equivalent to 128 pulses of position error amount(DGN300).

Countermeasures

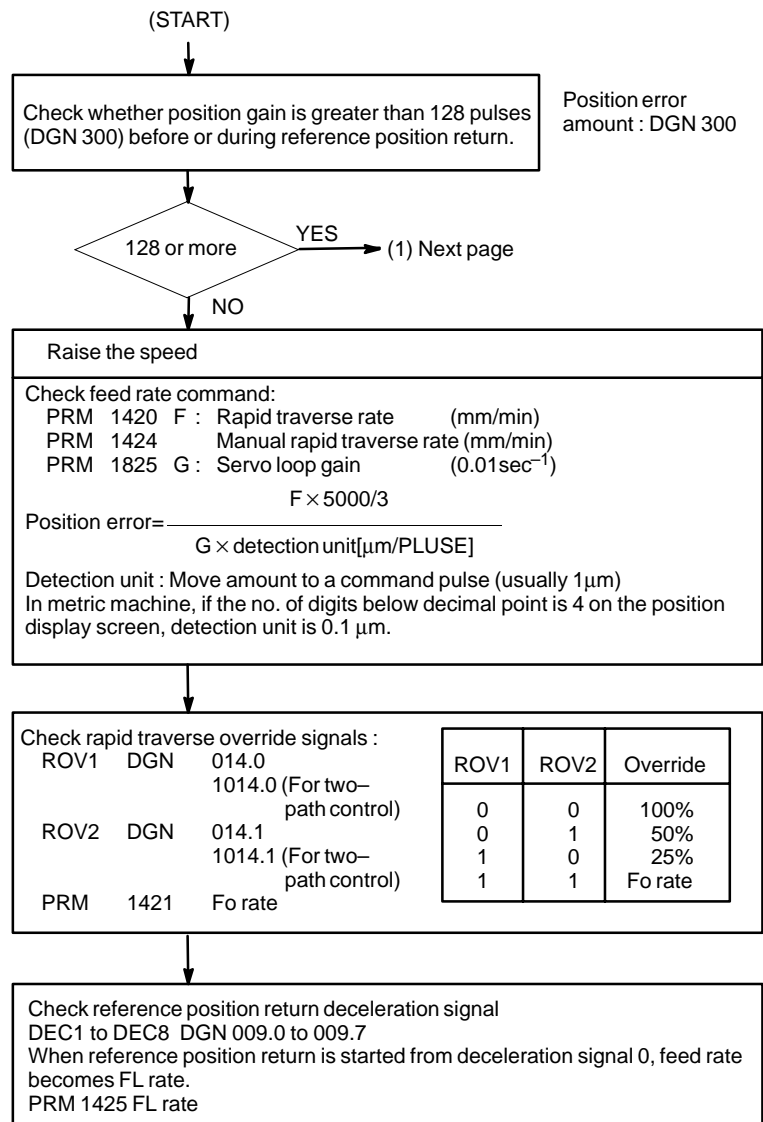

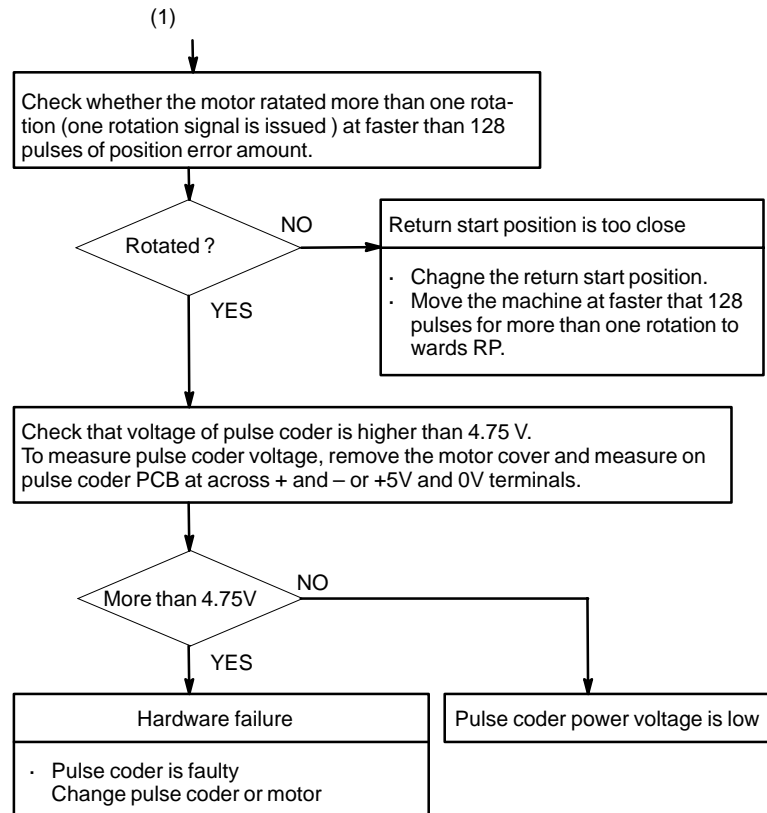
**CAUTION**

After the pulse coder or motor is exchanged, reference position or machine's standard point may be different from former one. Please set it correctly.

- **Reference**

A speed more than 128 pulses is required because if speed is lower than this, one-rotation signal does not function stably, causing improper position detection.

If bit 0 of parameter No. 2000 is set to 1, a speed corresponding to a positional deviation of 1280 pulses or more is required.

Parameter No. 1836 can be set to 128 or less, as the minimum positional deviation with which reference position return is possible. (If the parameter is set to 0, 128 is assumed as the minimum positional deviation. If bit 0 of parameter No. 2000 is set to 1, a value equal to ten times the set value is used for checking.)

8.13 ALARM 300 (REQUEST FOR REFERENCE POSITION RETURN)

Absolute position data in the serial pulse coder was lost.
(This alarm will be generated when serial pulse coder is exchanged or position feedback signal cable of the serial pulse coder is disconnected).

Remedies

- When reference position return function is present

Machine position must be memorized using the following method:

- (1) Execute manual reference position return only for an axis for which this alarm was generated. When manual reference position return cannot be executed because of another alarm, set parameter 1815#5 to 0 and release the alarm and perform manual operation.
- (2) Press  key at the end of reference position return to release the alarm.

- When reference position return function is not present

Execute dogless reference position setting to memorize the reference position.

- When serial pulse coder is changed

Since the reference position is different from the former one, change the grid shift value (PRM 1850) to correct the position.

Related parameters

| | | | | | | | | |
|------|----|----|-------|------|----|----|----|----|
| | #7 | #6 | #5 | #4 | #3 | #2 | #1 | #0 |
| 1815 | | | APC x | APZx | | | | |

#5(APCx) 0 : Position detector is incremental pulse coder.

1 : Position detector is absolute pulse coder.

#4(APZx) Reference position of absolute pulse coder is :

0 : not established

1 : established

8.14 ALARM 401 (V READY OFF)

Causes and actions

This alarm is issued if the servo ready signal (VRDY) of a servo amplifier does not turn on or if the signal turns off during operation.

There are cases in which this alarm is issued because another servo alarm is issued. If this occurs, first take the action for the first alarm.

Check the power magnetic circuit around the amplifier. The servo amplifier or the axis control cards on the CNC may be defective.

- VRDY

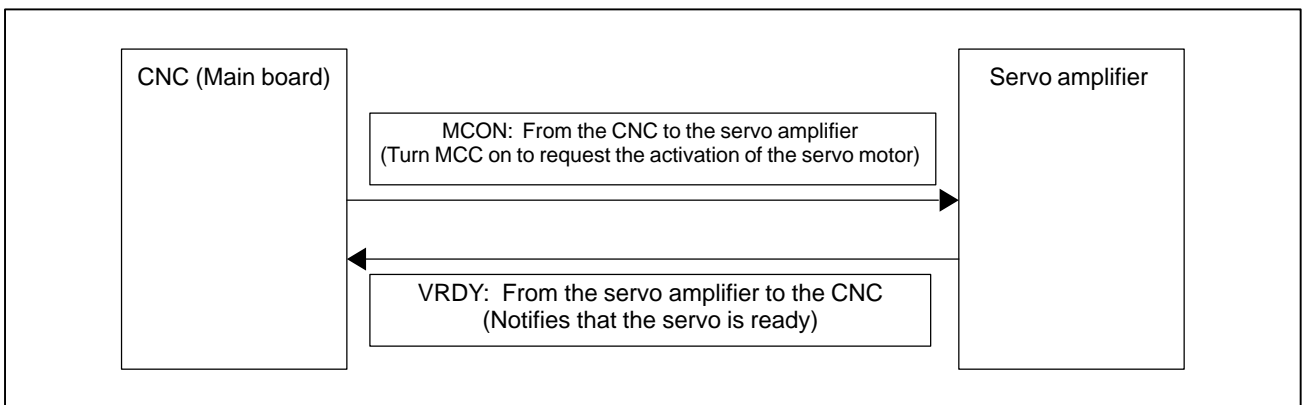

The exchange of this information is performed via the FSSB (optical cable).

- Example of connection around the amplifier (Typical example)

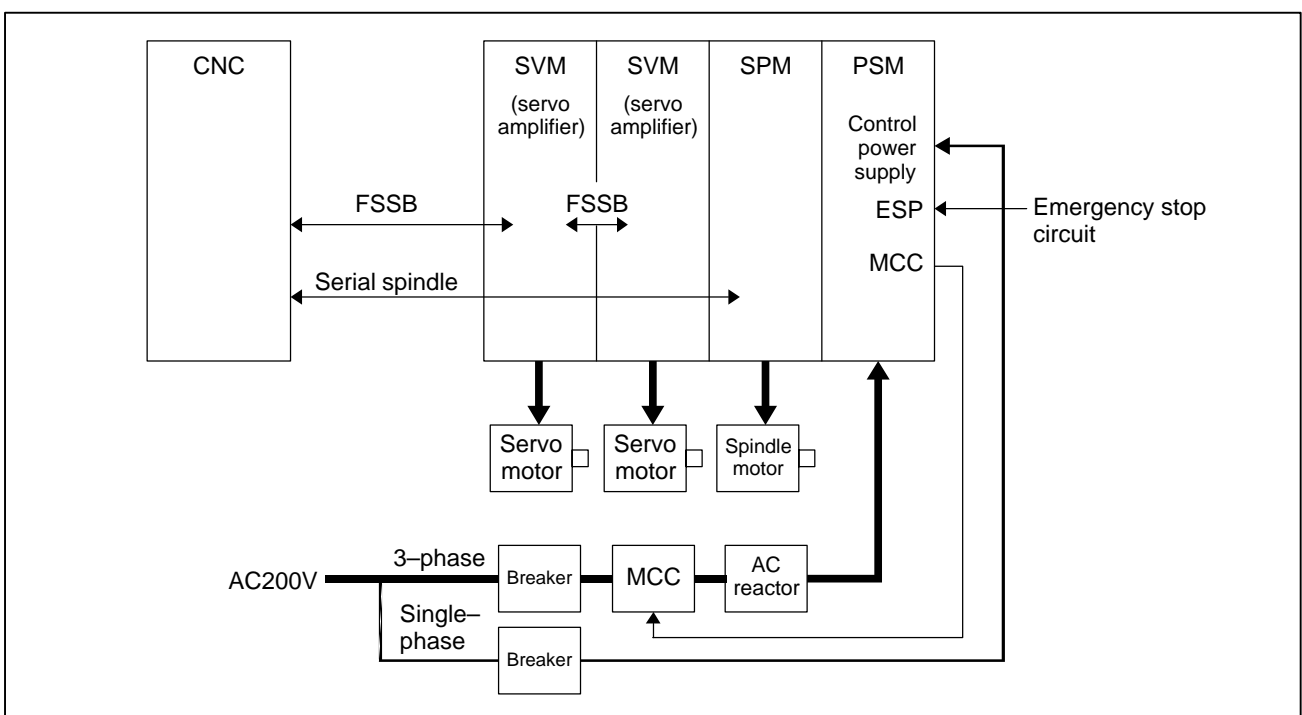

Check items

- Is the PSM control power supply on?
- Has an emergency stop been canceled?
- Is a terminating connector connected to the JX1B connector of the terminating amplifier?
- Is MCC on? If there is an external MCC sequence in addition to the MCC contact of the PSM, check that sequence also.
- Is the power for driving MCC supplied?
- Is the breaker on?
- Has some alarm been issued in the PSM or SPM?

- **Replacing the servo amplifier**

If no problem is found in the power magnetic circuit around the amplifier, replace the servo amplifier.

- **Replacing the axis control cards**

If the above action does not solve the problem, replace the axis control card.

See Section 2.4, “CONNECTOR AND CARD CONFIGURATIONS OF PRINTED CIRCUIT BOARDS” for an explanation of the mounting locations of the cards.

8.15 ALARM 404 (V READY ON)

Causes and actions

This alarm is issued if the servo ready signal (VRDY) of a servo amplifier remains on.

The servo amplifier or the axis control cards on the CNC may be defective.

• VRDY

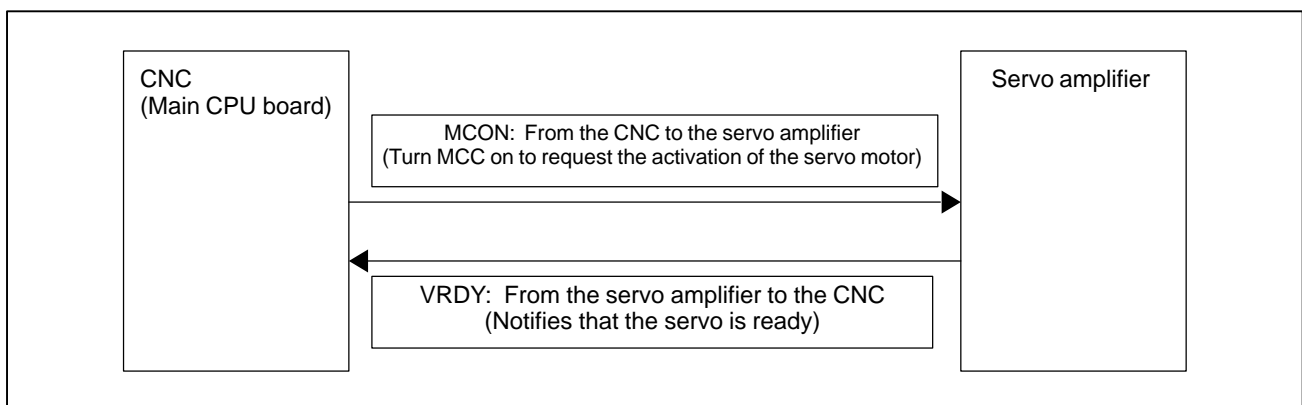

The exchange of this information is performed via the FSSB (optical cable).

This alarm is issued if VRDY remains on when the CNC turns MCON off or if VRDY turns on before the CNC turns MCON on.

• Replacing the servo amplifier

The servo amplifier may be defective. Replace the servo amplifier.

• Replacing the axis control cards

If replacing the servo amplifier does not solve the problem, replace the axis control card.

See Section 2.4, “CONNECTOR AND CARD CONFIGURATIONS OF PRINTED CIRCUIT BOARDS” for an explanation of the mounting locations of the cards.

8.16

ALARM 462

(SEND CNC DATA
FAILED)

ALARM 463

(SEND SLAVE DATA
FAILED)

Causes and actions

Alarm 462 is issued if a slave (servo amplifier) cannot receive correct data due to an FSSB communication error.

Alarm 463 is issued if the CNC cannot receive correct data due to an FSSB communication error.

If these alarms are issued, the alarm message indicates the number of the defective axis (axis name).

- **Servo amplifier or optical cable**

Any of the optical cables between the CNC control unit and the amplifier corresponding to the axis number indicated in the alarm message may be defective.

Or, any of the first amplifier to the amplifier corresponding to that axis number may be defective.

- **Axis control cards**

The axis control card installed on the CNC may be defective.

See Section 2.4, "CONNECTOR AND CARD CONFIGURATIONS OF PRINTED CIRCUIT BOARDS" for an explanation of the mounting locations of the cards.

8.17 ALARM 417 (DIGITAL SERVO SYSTEM IS ABNORMAL)

Digital servo parameters are abnormal.
(Digital servo parameters are set incorrectly.)

• Causes

- 1 Confirm the setting value of the following parameters:
 PRM 2020 : Motor format number
 PRM 2022 : Motor rotation direction
 PRM 2023 : Number of pulses of velocity feedbacks
 PRM 2024 : Number of pulses of position feedback
 PRM 1023 : Servo axis number
 PRM 2084 : Flexible feed gear ratio
 PRM 2085 : Flexible feed gear ratio
 Confirm the details with diagnosis function of CNC side.
- 2 Change the setting of this parameter to 0.
 PRM 2047 : Observer parameter
- 3 Perform initial setting of digital servo parameters.
 Refer to section 6.1 “Initial Setting of Servo Parameters” .

This data indicates the cause of servo alarm No. 417, detected by the NC.
 If the alarm is detected by the servo, the PRM bit (bit 4 of DGN No. 0203)
 is set to 1.

| | #7 | #6 | #5 | #4 | #3 | #2 | #1 | #0 |
|------|----|-----|----|-----|-----|-----|----|-----|
| 0280 | | AXS | | DIR | PLS | PLC | | MOT |

- #0(MOT)** : The motor type specified in parameter No. 2020 falls outside the predetermined range.
- #2(PLC)** : The number of velocity feedback pulses per motor revolution, specified in parameter No. 2023, is zero or less. The value is invalid.
- #3(PLS)** : The number of position feedback pulses per motor revolution, specified in parameter No. 2024, is zero or less. The value is invalid.
- #4(DIR)** : The wrong direction of rotation for the motor is specified in parameter No. 2022 (the value is other than 111 or -111).
- #6(AXS)** : In parameter No. 1023 (servo axis number), a value that falls outside the range of 1 to the number of controlled axes is specified. (For example, 4 is specified instead of 3.) Alternatively, the values specified in the parameter are not consecutive.

8.18 ALARM 700 (OVERHEAT: CONTROL UNIT)

Causes and actions

This alarm is issued if the ambient temperature of the CNC control unit is abnormally high. As an installation condition, the ambient temperature of the CNC must not exceed 55°C.

- **Ambient temperature**

A temperature monitoring circuit is installed on the main board, and causes this alarm to be issued if the ambient temperature is abnormally high.

Take appropriate action to the cabinet that houses the CNC control unit so that the temperature falls within the proper temperature range 0 to 58°C.

If it is obvious that the ambient temperature is not abnormal, the main board may be defective.

8.19 ALARM 701 (OVERHEAT: FAN MOTOR)

Causes and actions

- **Fan motors**

This alarm is issued if a fault occurs in any of the fan motors, such as the stoppage of a fan motor during the operation of the CNC.

Fan motors are installed in the uppermost portion of the CNC control unit. Each fan motor is attached with an alarm detector circuit, which notifies the CNC of a fault such as the stoppage of the fan motor, thereby issuing this alarm.

If this alarm is issued, replace the fan motor.

See Section 2.11 for an explanation of the replacement procedure.

8.20 ALARM 704 (SPINDLE SPEED FLUCTUATION DETECTION ALARM)

Spindle speed changes abnormally due to load.

Remedies

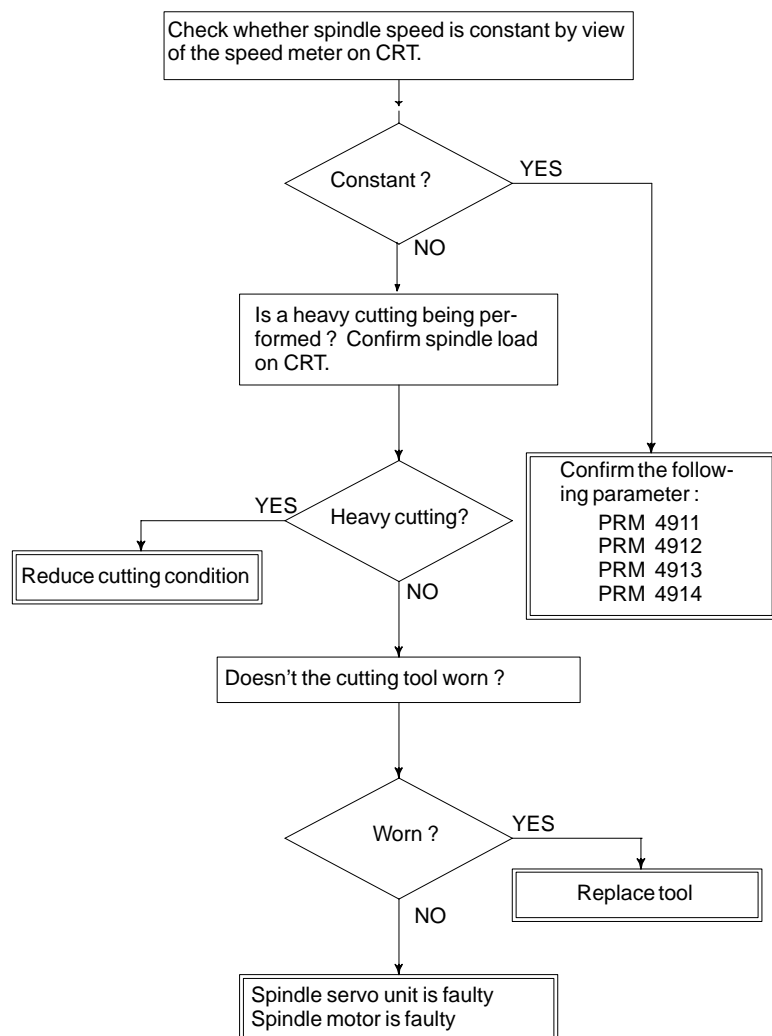

Remedies

PRM 4911 : A ratio of spindle speed at which actual spindle speed is regarded as arrived at a command spindle speed.

PRM 4912 : Spindle speed fluctuation ratio up to which the spindle speed fluctuation detection alarm is not issued.

PRM 4913 : Spindle speed fluctuation that is not regarded as the spindle speed fluctuation alarm.

PRM 4914 : Time when a spindle speed changed to when spindle speed fluctuation detection is started.

8.21 ALARM 749 (SERIAL SPINDLE COMMUNICATION ERROR)

Causes and actions

An error occurred in the communication between the serial spindle amplifier (SPM) and the CNC. The probable causes include:

- Contact failure of the connection cable
- Defective printed circuit board on the CNC
- Defective spindle amplifier
- Noise

- **Connection cable**

Check that the cable connecting the serial spindle amplifier (SPM) to the CNC is in contact.

Check that the cable is inserted firmly into the connectors and that it does not have any conductors likely to be cut off.

Check that the cable used is a twisted-pair cable and that it is connected as described in the connection manual.

- **Printed circuit boards on the CNC**

A spindle control circuit for the CNC is installed on the main board. If this alarm is issued, replace the main board.

- **Spindle amplifier module (SPM)**

When an error occurred on the spindle amplifier module (SPM) side, a code of A, A1, or A2 is indicated on the SPM depending on the nature of the error.

In this case, take appropriate actions in the Maintenance Manual of your servo motor.

- **Noise environment**

If any of the above actions does not solve the problem, examine the noise environment of the connection cable.

See the section on the measures against noise, take appropriate actions such as the reinforcement of the cable shield and the separation of the cable from the power line.

8.22

ALARM 750 (SPINDLE SERIAL LINK STARTUP FAILURE)

Causes and actions

This alarm is issued if a serial spindle amplifier (SPM) does not enter the normal startup state when the CNC is turned on.

This alarm is not issued once the CNC system including the spindle amplifiers has started up normally. It is issued if a fault occurs in the power-on process.

The probable causes include the following:

- Contact failure, wiring error, or connection error of the connection cable
- The CNC is turned on when a spindle amplifier is in the alarm state.
- Parameter setting error
- Defective printed circuit board on the CNC
- Defective spindle amplifier

● Connection

Up to two serial spindle amplifiers (SPMs) can be connected per path. Note, however, the number of amplifiers that can be connected differs depending on the model, number of paths, and configuration. Refer to the Connection Manual (Hardware).

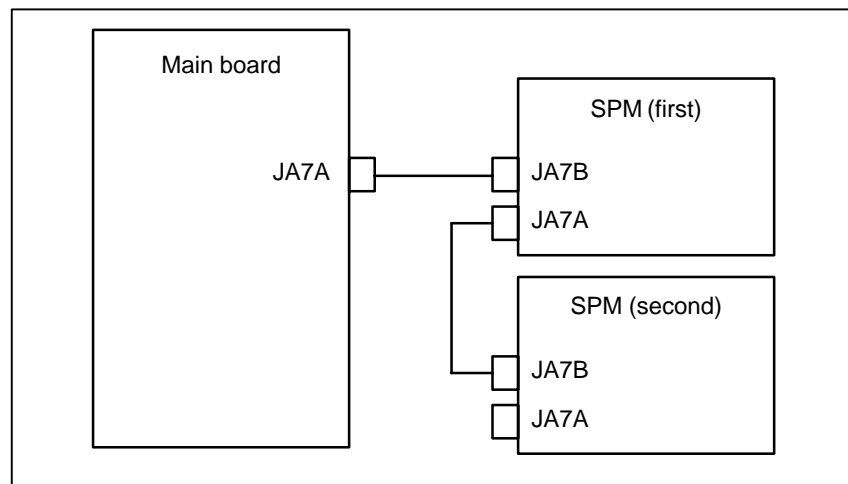

Check that the cables are connected as shown in the figure above. Check that JA7Bs and JA7As are connected correctly.

Check that the cables are latched firmly and are not loose.

Refer to the Connection Manual (Hardware) to check that the cables are connected correctly.

● States of the spindle amplifiers

This alarm is issued if the CNC is turned on when the LED of a spindle amplifier indicates a number other than “24”.

On the spindle amplifier, remove the cause of the alarm. Turn off the spindle amplifier and the CNC, then turn on the system again.

● Details of the alarm

If this alarm is issued, its details can be checked with diagnosis numbers 409 and 439.

● 1st and 2nd spindles

| | | | | | | | | |
|------|----|----|----|----|-----|-----|-----|-----|
| | #7 | #6 | #5 | #4 | #3 | #2 | #1 | #0 |
| 0409 | | | | | SPE | S2E | S1E | SHE |

SPE: 0 : In the spindle serial control, the serial spindle parameters fulfill the spindle unit startup conditions.

1 : In the spindle serial control, the serial spindle parameters do not fulfill the spindle unit startup conditions.

S2E: 0 : The second spindle is normal during the spindle serial control startup.

1 : The second spindle was detected to have a fault during the spindle serial control startup.

S1E: 0 : The first spindle is normal during the spindle serial control startup.

1 : The first spindle was detected to have a fault during the spindle axis serial control startup.

SHE: 0 : The serial communications circuit in the CNC is normal.

1 : The serial communications circuit in the CNC was detected to have a fault.

8.23**ALARM 5134
(FSSB: OPEN
READY TIME OUT)****ALARM 5135 (FSSB:
ERROR MODE)****ALARM 5137 (FSSB:
CONFIGURATION
ERROR)****ALARM 5197 (FSSB:
OPEN TIME OUT)****ALARM 5198 (FSSB:
ID DATA NOT READ)****Causes and actions**

These alarms are issued if any of the axis control cards and the slaves (such as servo amplifiers) and optical cables connected to the FSSB is defective.

| No. | Message | Description |
|------|---------------------------|---|
| 5134 | FSSB: OPEN READY TIME OUT | The FSSB did not become ready to open during initialization. |
| 5135 | FSSB: ERROR MODE | The FSSB entered an error mode. |
| 5137 | FSSB: CONFIGURATION ERROR | The FSSB detected a configuration error. |
| 5197 | FSSB: OPEN TIME OUT | The FSSB did not open when the CNC had allowed the FSSB to open. |
| 5198 | FSSB: ID DATA NOT READ | The initial ID information for the amplifier cannot be read because of a failure in the temporary assignment. |

- **Processing of the FSSB at power on**

The processing of the FSSB at power on is as described below:

- 1 The CNC initializes the FSSB and the servo.
- 2 The servo returns the first ready signal.
- 3 The first ITP interrupt is generated.
- 4 The CNC waits for the FSSB to become ready to open.
- 5 The CNC checks that the FSSB did not detect a configuration error.
- 6 The CNC allows the FSSB to open.
- 7 The CNC checks that the FSSB has opened.
- 8 The servo returns the second ready signal.
- 9 Normal operation

If the FSSB does not become ready to open in 4, alarm 5134 is issued.
If an error is detected in 5, alarm 5137 is issued.
If the FSSB does not open within a fixed period of time, alarm 5197 is issued.
If the ready signal is not returned within a fixed period of time, alarm 5198 is issued.

- **Checking the parameter settings**

Check that the FSSB-related parameters are set correctly.

- **Power supplies of the servo amplifiers**

Check the power supplies of the servo amplifiers connected to the FSSB.

- **Replacing the axis control cards, optical cables, and servo amplifiers**

Replace the axis control cards on the CNC.
Replace the optical cables and servo amplifiers connected to the FSSB, one at a time, to identify the defective item.
See Section 2.4, “CONNECTOR AND CARD CONFIGURATIONS OF PRINTED CIRCUIT BOARDS” for an explanation of the mounting locations of the cards.

8.24

ALARM 5136 (FSSB: NUMBER OF AMPS IS SMALL)

Causes and actions

The number of servo amplifiers recognized by the FSSB is insufficient, compared with the number of controlled axes.

- **FSSB setting screen**

If this alarm is issued, display the amplifier setting screen from the FSSB setting screen. Only the servo amplifiers recognized on the FSSB are displayed.

- **Optical cable or servo amplifier**

The optical cable that connects together the last recognized amplifier and the next one may be defective.

Or, either of the amplifiers connected together with that optical cable may be defective. Check the power supplies of the amplifiers.

- **Power fault of a servo amplifier**

This alarm may be issued if a power fault occurs in a servo amplifier. A power fault occurs if the amplifier control power supply voltage drops, if the +5 V conductor of the pulse coder cable is ground, or for other reasons.

- **Axis control cards**

The axis control cards installed on the CNC may be defective.

See Section 2.4, “CONNECTOR AND CARD CONFIGURATIONS OF PRINTED CIRCUIT BOARDS” for an explanation of the mounting locations of the cards.

8.25 ALARM 900 (ROM PARITY)

Causes and actions

A ROM parity error occurred.

The software including the CNC system software, servo software, PMC management software, and PMC Ladder is stored in the flash memory on the FROM/SRAM module. It starts execution after being loaded into the RAM of the DRAM module or servo card at power on.

A ROM parity error occurs if the software stored in the FROM/SRAM module is destroyed.

- **Rewriting the software component**

On the screen, the series of the software in which a fault was detected is displayed. Rewrite the software using the boot system.

The software stored in the FROM/SRAM module includes a variety of FANUC software components, as well as those created by the MTB, such as the PMC Ladder.

- **Replacing the FROM/SRAM module**

Replace the FROM/SRAM module

After replacement, all the software that was once stored must be written. Because the replacement clears the contents of the SRAM memory, the memory contents must be restored. For this operation, use the boot system.

- **Replacing the main board**

If any of the above actions does not solve the problem, replace the main board

See Section 2.4, "CONNECTOR AND CARD CONFIGURATIONS OF PRINTED CIRCUIT BOARDS" for an explanation of the mounting locations of the cards.

8.26

ALARMS 912 TO 919 (DRAM PARITY)

Causes and actions

The management software for the CNC is loaded from the FROM to the DRAM at power on, so that it is executed on the DRAM.

A parity error occurred on this DRAM.

These alarms occur if the data on the DRAM is destroyed due to some external cause or if the CPU card is defective.

- **Replacing the CPU card.**

Replace the CPU card.

The DRAM is mounted on the CPU card.

See Section 2.4, "CONNECTOR AND CARD CONFIGURATIONS OF PRINTED CIRCUIT BOARDS" for an explanation of the mounting locations of the cards.

NOTE

If the drawing number of the basic unit is A02B-0309-B52n, A02B-0311-B52n, or A02B-0311-B53n (where n is 0, 1, ..., 9), references to the CPU card should be read as the main board.

8.27

ALARM 920 (SERVO ALARMS)

Causes and actions

A watchdog error or RAM parity error occurred in the circuit on an axis control card.

Alarm 920 indicates that either of the above errors occurred in the control circuit for axes 1 to 4.

The optical cable, axis control cards, CPU card, or motherboard may be defective.

- **Watchdog error**

The servo control circuit monitors the operation of the main CPU. If a fault occurs in the CPU or its peripheral circuit, so that the watchdog timer is not reset, a watchdog error occurs.
- **Replacing the optical cable**

Replace the optical cable. A defective optical cable may cause this problem.
- **Replacing the axis control cards**

Replace the axis control cards.
- **Replacing the CPU card**

Replace the CPU card.
- **Replacing the main board**

If any of the above actions does not solve the problem, replace the main board.
See Section 2.4, “CONNECTOR AND CARD CONFIGURATIONS OF PRINTED CIRCUIT BOARDS” for an explanation of the mounting locations of the cards.

8.28 ALARM 926 (FSSB ALARM)

Causes and actions

A fault occurred on the FSSB (serial servo bus) that connects servo amplifiers to the CNC.

This alarm is issued if a fault occurs in any of the axis control cards making up the FSSB, optical cables, and servo amplifiers.

- Identifying the defective location

Use the LEDs on the servo amplifiers.

Using the 7-segment LEDs installed on the servo amplifiers, the defective location can be identified.

FSSB connection example

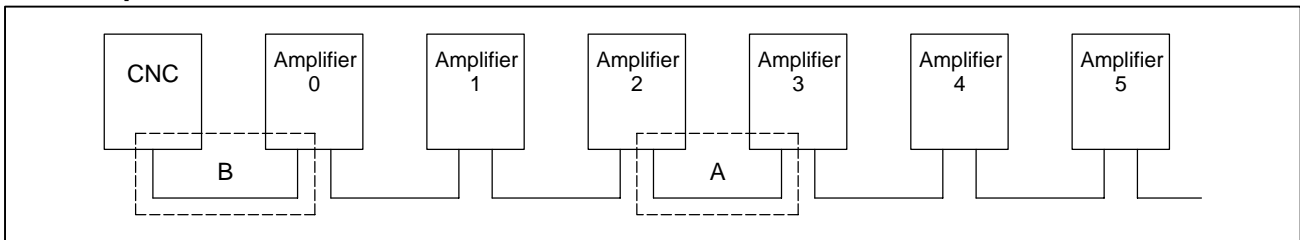

If portion A, indicated by dotted line, contains the defective location, the LEDs on the servo amplifiers will be as shown in the table below.

| Amplifier No. | Amplifier 0 | Amplifier 1 | Amplifier 2 | Amplifier 3 | Amplifier 4 | Amplifier 5 |
|---------------|-------------|-------------|-------------|-------------|-------------|-------------|
| LED display | “_” | “_” | “L” or “_” | “U” | “U” | “U” |

In this case, any of the following locations may be defective:

- (1) Optical cable connecting together the servo amplifier whose LED is “L” or “_” and that whose LED is “U”. In the above figure, the optical cable in portion A may be defective.
- (2) Either of the servo amplifier whose LED is “L” or “_” and that whose LED is “U”. In the above figure, either amplifier 2 or 3 may be defective.

If portion B, indicated by dotted line, contains the defective location, the LEDs on the servo amplifiers will be as follows:

| Amplifier No. | Amplifier 0 | Amplifier 1 | Amplifier 2 | Amplifier 3 | Amplifier 4 | Amplifier 5 |
|---------------|-------------|-------------|-------------|-------------|-------------|-------------|
| LED display | “_” or “U” | | | | | |

In this case, any of the following locations may be defective:

- (1) Optical cable connected to the CNC. In the above figure, the optical cable in portion B may be defective.
- (2) Any of the axis control cards in the CNC
- (3) First servo amplifier connected. In the above figure, amplifier 0 may be defective.

● **Identifying the defective location**

Use the display on the CNC screen

If alarm 926 is issued, information such as the following is displayed at the bottom of the CNC screen. It can be used to identify the defective location.

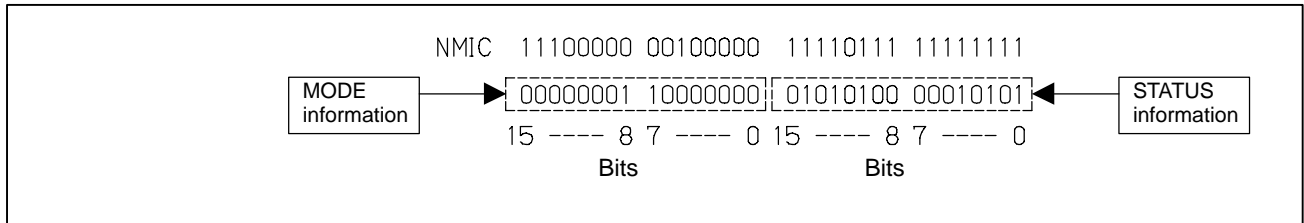

Bits 12 to 15 of the MODE information indicate the number of the slave in which the alarm occurred. The unit nearest the CNC (such as a servo amplifier) is assigned a slave number of “0”. For a 2-axis amplifier, for example, one number is assigned for the first axis, and the next number is assigned for the second.

Details of the MODE information

| Bit | 15 | 14 | 13 | 12 | 11 | ← | → | 0 |
|-------------|---|----|----|----|------------|---|---|---|
| Description | Number of the slave in which the alarm occurred | | | | No meaning | | | |

0000: Indicates that the alarm occurred in slave 0.
 0001: Indicates that the alarm occurred in slave 1.
 ...
 1001: Indicates that the alarm occurred in slave 9.

Using the bits of the STATUS information, the fault can be estimated.

Details of the STATUS information

| Bit | 15 | ← | → | 12 | 11 | 10 | 9 | 8 | 7 | 6 | 5 | 4 | 3 | ← | → | 0 |
|-------------|------------|---|---|----|----------------|--------------------|-------------------|------------|---|---|--------------------|------------|----------------|------------|---|---|
| Description | No meaning | | | | External alarm | Broken master port | Broken slave port | No meaning | | | Broken master port | No meaning | Error on slave | No meaning | | |
| A | xxxx | | | | 0 | 0 | 0 | x x | | | 1 | x | 0 | xxxx | | |
| A | xxxx | | | | 0 | 1 | 0 | x x | | | 0 | x | 1 | xxxx | | |
| B | xxxx | | | | 0 | 0 | 1 | x x | | | 0 | x | 1 | xxxx | | |
| C | xxxx | | | | 1 | 0 | 0 | x x | | | 0 | x | 1 | xxxx | | |

The STATUS information matches any of the patterns A, B, and C. (x indicates a bit that may be either 0 or 1.)

If the pattern of the STATUS information is A

- (1) The optical cable that connects together the slave corresponding to bits 12 to 15 of the MODE information and the preceding slave may be defective. Or, either of the slaves connected together with that optical cable may be defective.
- (2) The voltage of the power supplied to the slave amplifier dropped, or a power fault occurred in the amplifier.
- (3) Any of the axis control cards in the CNC may be defective.

If the pattern of the STATUS information is B

- (1) The optical cable that connects together the slave corresponding to bits 12 to 15 of the MODE information and the preceding slave may be defective. Or, either of the slaves connected together with that optical cable may be defective.
- (2) The voltage of the power supplied to the slave amplifier dropped, or a power fault occurred in the amplifier.

If the pattern of the STATUS information is C

- (1) The slave corresponding to bits 12 to 15 of the MODE information may be defective.
- (2) The voltage of the power supplied to the slave amplifier dropped, or a power fault occurred in the amplifier.

- **Power fault in a servo amplifier**

If a power fault occurs in a servo amplifier, the FSSB alarm is issued. A power fault occurs, causing the FSSB alarm to be issued, if the amplifier control power supply voltage drops, if the +5 V conductor of the pulse coder cable is ground, or for other reasons.

- **Replacing the axis control card**

If any of the axis control cards is found defective by the above diagnosis, replace the axis control card on the main board. See Section 2.4, "CONNECTOR AND CARD CONFIGURATIONS OF PRINTED CIRCUIT BOARDS" for an explanation of the mounting locations of the cards.

8.29

ALARM 930 (CPU INTERRUPT)

Causes and actions

An interrupt that can never be generated during normal operation was generated.

The cause of the fault cannot be identified, but the fault may have occurred in the peripheral circuit of the CPU.

If the problem is solved by turning the power off and then on again, the problem may be attributable to noise.

- **Replacing the CPU card, main board**

Replace the CPU card and the main board.

See Section 2.4, "CONNECTOR AND CARD CONFIGURATIONS OF PRINTED CIRCUIT BOARDS" for an explanation of the mounting locations of the cards.

- **Examining the noise environment**

See the section on the measures against noise, examine the noise environment of the CNC.

8.30 ALARM 935 (SRAM ECC ERROR)

Causes and actions

An ECC error occurred in the SRAM used to store data such as parameters and machining programs.

This alarm is issued if the battery has run down or if the data in the SRAM is destroyed due to some external cause. Or, the FROM/SRAM module or main board may be defective.

- **ECC check**

This is the method of checking the data stored in the SRAM. It has been employed instead of the conventional parity check.

With the ECC check method, 8-bit correction data is provided for 16-bit data, so that if a data error occurs in one of these 16 bits, the error is automatically corrected with the correction data, allowing the CNC to continue operation. This alarm is issued if a data error occurs in two or more bits.

With the conventional parity check method, a system alarm is issued if a data error occurs even in one bit.

- **Checking the battery**

The battery is rated 3 V. A battery alarm is issued and “BAT” flashes on the screen if the voltage of the battery drops to 2.6 V.

If a battery alarm is issued, replace the battery with a new one promptly.

- **Performing memory all clear**

Perform a memory all clear operation, then start up the CNC. Alternatively, if a backup of the data in the SRAM has been made, use the backup to restore the data. To back up and restore the data in the SRAM, use the boot system.

- **Replacing the FROM/SRAM module**

If memory all clear or the restoration of the data with a backup does not solve the problem, replace the FROM/SRAM module. Take a backup copy in advance. All the software must be restored after the replacement. After replacing the FROM/SRAM module, perform a memory all clear operation and start up the CNC. All the data must be re-loaded.

If a backup is available, restore the data using the backup, then start up the CNC.

- **Main board**

If any of the above actions does not solve the problem, replace the main board.

See Section 2.4, “CONNECTOR AND CARD CONFIGURATIONS OF PRINTED CIRCUIT BOARDS” for an explanation of the mounting locations of the cards.

8.31 ALARM 950 (PMC SYSTEM ALARM)

Causes and actions

This alarm is issued if a fault is detected in the PMC.
The probable causes include an I/O link communication error and a defective PMC control circuit

• **Connecting the I/O Link**

The I/O Link is a serial interface that connects the CNC to various I/O devices and allows transfers of I/O signals between devices at high speed. When multiple devices are connected using the I/O Link, there forms a relationship that a certain device is a master and the other devices are slaves. The states of the input signals from the slaves are transferred to the master at fixed intervals. The output signals from the master are transferred to the slaves at fixed intervals. In a CNC system, the master is the CNC (main board).
The I/O signals transferred via the I/O link can be used with the PMC Ladder.

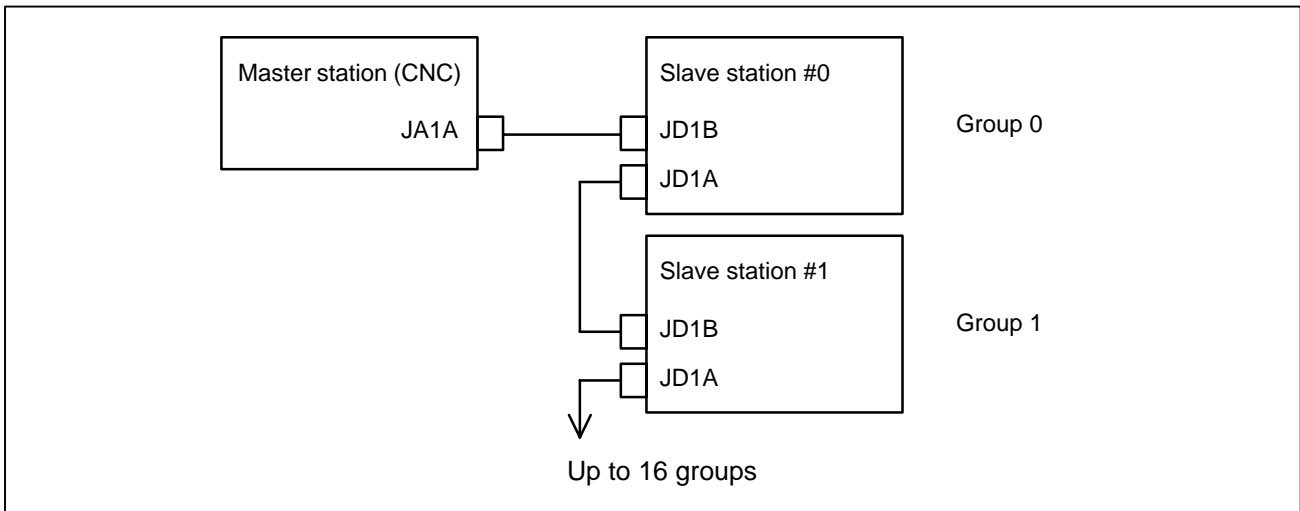

• **I/O Link communication error PC050**

If alarm 950 is issued, displaying “PC050” on the screen, an I/O link communication error may have occurred.

Screen display example

| | |
|----------------------|----------------|
| SYSTEM ALARM | |
| 950 PMC SYSTEM ALARM | |
| PC050 I/OLINK(CH1) | xx:yy-aa:bb |
| or | |
| PC050 I/OLINK(CH2) | aa:bb-xx:yy |
| or | |
| PC050 IOLINK CH1 | aabb-xyyy:aabb |
| or | |
| PC050 IOLINK CH2 | aabb:aabb-xyyy |

In this screen display example, the cause of the alarm can be estimated using xx:yy. xx and yy are hexadecimal representations. CH1 and CH2 are channels on which communication failed.

- 1) If bit 0 of the binary representation of xx is “1”, this indicates that the master station (CNC) received invalid communication data. For example, assume that the following is displayed on the screen:

| |
|--|
| SYSTEMALARM 950 PMC SYSTEMALARM PC050 IOLINK CH1 aabb-4142:aabb |
|--|

xx is equal to 41, or “01000001” in binary notation. Bit 0, which is the lowest (rightmost) bit, is “1”.

In this case, check the following:

- (1) Noise environment of the I/O Link cable
Noise may disturb the data on the I/O Link and may result in a problem.
- (2) Contact of the I/O Link cable
Check that the I/O link cable is in contact. Check that the cable is not loose and is latched firmly.
- (3) Cable failure
Check that the I/O Link cable is connected properly.
- (4) Device failure
The main board or any of the I/O devices connected to the I/O Link may be defective. Replace the devices, one at a time, to identify the defective device.

Refer to 2) if bit 1 (second bit from the right) is also “1”.

- 2) If bit 1 of the binary representation of xx is “1”, this indicates that an error was detected on a slave station (I/O device). For example, assume that the following is displayed on the screen:

| |
|--|
| SYSTEMALARM 950 PMC SYSTEMALARM PC050 IOLINK CH1 aabb-4382:aabb |
|--|

xx is equal to 43, or “01000011” in binary notation. Bit 1 (second bit from the right) is “1”.

In this case, yy indicates the following:

Number equal to the number indicated by bits 0 to 4 of yy minus 1:
Group number of the slave station on which an error was detected

Bit 5 of yy:

Invalid communication data was detected on the slave.

Bit 6 of yy:

Another error was detected on the slave.

Bit 7 of yy:

A watchdog or parity error was detected on the slave.

In the example shown in the figure above, yy is equal to 82, or “10000010” in binary notation. Bits 0 to 4 are “00010” (2 in decimal notation). The number “1”, which is equal to that number minus 1, is the group number of the slave station on which an error was detected. Bit 7 is “1”. Thus, a watchdog or parity error was detected on the slave station in group 1.

In this case, check the following:

- (1) If bit 5 of yy is “1”
Perform examination with the same procedure as that in 1).
- (2) If bit 6 of yy is “1” or if bit 7 of yy is “1”
First, replace the device of the slave station of the indicated group number.
If the problem is not solved, perform examination with the same procedure as that in 1) to identify the defective location.
- 3) If bit 2 of the binary representation of xx is “1”, this indicates that the link between the master station (CNC) and the slave station was canceled. For example, assume that the following is displayed on the screen:

| | |
|----------------------|----------------|
| SYSTEM ALARM | |
| 950 PMC SYSTEM ALARM | |
| PC050 IOLINK CH1 | aabb-8400:aabb |

xx is equal to 84, or “1000100” in binary notation. Bit 2, which is the third bit from the right, is “1”.

In this case, check the following:

- (1) Disconnection of the slave station from the power supply
Check that the slave station is not turned off, that there are no instantaneous power failures, and that the capacity of the power supply is enough.
- (2) Disconnection of the I/O link cable
Check that the I/O link cable has not fallen off or has not been disconnected.
- (3) If the problem is not solved, perform a check with the same procedure as that in 1).
- 4) If bit 3 or 4 of the binary representation of xx is “1”, this indicates that a parity error occurred in the PMC control circuit on the main board.
In this case, replace the motherboard (main board).

- **Other cases**

The main board may be defective. Replace the main board.
See Section 2.4, “CONNECTOR AND CARD CONFIGURATIONS OF PRINTED CIRCUIT BOARDS” for an explanation of the mounting locations of the cards.

8.32 ALARM 951 (PMC WATCHDOG ALARM)

Causes and actions

- **Replacing the main board**

This alarm is issued if a fault (watchdog alarm) is detected in the PMC. A probable cause is that the MC control circuit is defective.

The PMC control circuit is installed on the main board. Replace the main board.

See Section 2.4, “CONNECTOR AND CARD CONFIGURATIONS OF PRINTED CIRCUIT BOARDS” for an explanation of the mounting locations of the cards.

8.33

ALARM 972 (NMI ALARM ON AN OPTION BOARD) (Series 0i–C ONLY)

Causes and actions

This alarm indicates that an error was detected on an option board, not on the main board.

- **Screen display**

If alarm 972 is issued, the following is displayed on the screen:

Screen display example

```
SYSTEMALARM
972 NMI OCCURRED IN OTHER MODULE
SLOT 01
```

“SLOT” indicates the number of the slot into which the option board is inserted. Alternatively, it may indicate the number of the alarm that occurred on the option board. Take the action related to that alarm to the option board.

- **Replacing the option board**

Replace the option board inserted into the slot with the indicated slot number.

8.34 ALARM 973 (NMI ALARM WITH AN UNKNOWN CAUSE)

Causes and actions

An error that can never occur during normal operation occurred. The cause of the error cannot be identified.

- **Replacing printed circuit boards**

Replace all the printed circuit boards installed (including cards, modules, and the back panel), one at a time, to identify the defective printed circuit board.

Replace the CPU card, main board, and other printed circuit boards, one at a time.

See Section 2.4, “CONNECTOR AND CARD CONFIGURATIONS OF PRINTED CIRCUIT BOARDS” for an explanation of the mounting locations of the cards.

8.35 ALARM 974 (F-BUS ERROR)

Causes and actions

A bus error occurred on the FANUC-BUS connecting each option board.

This alarm indicates that a fault occurred during the exchange of data between the main and an option board.

- **Replacing the CPU card** Replace the CPU card on the main board. (If the drawing number of the basic unit is A02B-0309-B52n (where n is 0, 1, ..., 9, go to the next step.)
- **Replacing the main board** Replace the main board.
- **Replacing the option boards** Replace the installed option boards, one at a time.
- **Replacing the back panel** Replace the back panel (the power printed circuit board if the drawing number of the basic unit is A02B-0309-B52n (where n is 0, 1, ..., 9)). See Section 2.4, "CONNECTOR AND CARD CONFIGURATIONS OF PRINTED CIRCUIT BOARDS" for an explanation of the mounting locations of the cards.

8.36

ALARM 975 (BUS ERROR)

Causes and actions

A bus error occurred on the main board. This alarm indicates that an error occurred during the exchange of data within the main board.

- **Replacing the CPU card**

Replace the CPU card on the main board. (If the drawing number of the basic unit is A02B-0309-B52n (where n is 0, 1, ..., 9, go to the next step.)

- **Replacing other cards and modules**

Replace the display control card, axis control cards, and FROM/SRAM module, one at a time.

If the drawing number of the basic unit is A02B-0309-B52n, A02B-0311-B52n, or A02B-0311-B53n (where n is 0, 1, ..., 9), replace the axis control card and the FROM/SRAM module in that order.

- **Replacing the main board**

Replace the main board.

See Section 2.4, "CONNECTOR AND CARD CONFIGURATIONS OF PRINTED CIRCUIT BOARDS" for an explanation of the mounting locations of the cards.

8.37

ALARM 976 (LOCAL BUS ERROR)

Causes and actions

A bus error occurred on the local bus on the main board.

This alarm indicates that an error occurred during the exchange of data within the main board.

- **Replacing the CPU card**

Replace the CPU card on the main board (main board). (If the drawing number of the basic unit is A02B-0309-B52n (where n is 0, 1, ..., 9), go to the next step.)

- **Replacing other cards and modules**

Replace the display control card, axis control cards, and FROM/SRAM module, one at a time.

If the drawing number of the basic unit is A02B-0309-B52n, A02B-0311-B52n, or A02B-0311-B53n (where n is 0, 1, ..., 9), replace the axis control card and the FROM/SRAM module in that order.

- **Replacing the main board**

Replace the main board.

See Section 2.4, "CONNECTOR AND CARD CONFIGURATIONS OF PRINTED CIRCUIT BOARDS" for an explanation of the mounting locations of the cards.

8.38 SERVO ALARMS

For an explanation of the following servo alarms, refer to the Maintenance Manual of your servo motor.

| Number | Message | Contents |
|--------|--|--|
| 417 | SERVO ALARM: n-TH AXIS – PARAMETER INCORRECT | This alarm occurs when the n-th axis (axis 1–8) is in one of the conditions listed below. (Digital servo system alarm) <ol style="list-style-type: none"> 1) The value set in Parameter No. 2020 (motor form) is out of the specified limit. 2) A proper value (111 or –111) is not set in parameter No.2022 (motor revolution direction). 3) Illegal data (a value below 0, etc.) was set in parameter No. 2023 (number of speed feedback pulses per motor revolution). 4) Illegal data (a value below 0, etc.) was set in parameter No. 2024 (number of position feedback pulses per motor revolution). 5) Parameters No. 2084 and No. 2085 (flexible field gear rate) have not been set. 6) A value outside the limit of {1 to the number of control axes} or a non-continuous value (Parameter 1023 (servo axis number) contains a value out of the range from 1 to the number of axes, or an isolated value (for example, 4 not preceded by 3).was set in parameter No. 1023 (servo axisnumber). |
| 420 | SERVO ALARM: n AXIS SYNC TORQUE | During simple synchronous control, the difference between the torque commands for the master and slave axes exceeded the value set in parameter No. 2031. |
| 421 | SERVO ALARM: n AXIS EXCESS ER (D) | The difference between the errors in the semi-closed loop and closed loop has become excessive during dual position feedback. Check the values of the dual position conversion coefficients in parameters No. 2078 and 2079. |
| 422 | SERVO ALARM: n AXIS | In torque control of PMC axis control, a specified allowable speed has been exceeded. |
| 423 | SERVO ALARM: n AXIS | In torque control of PMC axis control, the parameter-set allowable cumulative travel distance has been exceeded. |
| 430 | n AXIS : SV. MOTOR OVERHEAT | A servo motor overheat occurred. |
| 431 | n AXIS : CNV. OVERLOAD | <ol style="list-style-type: none"> 1) PSM: Overheat occurred. 2) β series SVU: Overheat occurred. |
| 432 | n AXIS : CNV. LOWVOLT CON. | <ol style="list-style-type: none"> 1) PSM: The control power supply voltage has dropped. 2) PSMR: The control power supply voltage has dropped. 3) β series SVU: The control power supply voltage has dropped. |
| 433 | n AXIS : CNV. LOWVOLT DC LINK | <ol style="list-style-type: none"> 1) PSM: The DC link voltage has dropped. 2) PSMR: The DC link voltage has dropped. 3) α series SVU: The DC link voltage has dropped. 4) β series SVU: The DC link voltage has dropped. |
| 434 | n AXIS : INV. LOWVOLT CONTROL | SVM: The control power supply voltage has dropped. |
| 435 | n AXIS : INV. LOWVOLT DC LINK | SVM: The DC link voltage has dropped. |
| 436 | n AXIS : SOFTTHERMAL (OVC) | The digital servo software detected the soft thermal state (OVC). |
| 437 | n AXIS : CNV. OVERCURRENT POWER | PSM: Overcurrent flowed into the input circuit. |
| 438 | n AXIS : INV. ABNORMAL CURRENT | <ol style="list-style-type: none"> 1) SVM: The motor current is too high. 2) α series SVU: The motor current is too high. 3) β series SVU: The motor current is too high. |

| Number | Message | Contents |
|--------|------------------------------------|--|
| 439 | n AXIS : CNV. OVERVOLT POWER | <ol style="list-style-type: none"> 1) PSM: The DC link voltage is too high. 2) PSMR: The DC link voltage is too high. 3) α series SVU: The C link voltage is too high. 4) β series SVU: The link voltage is too high. |
| 440 | n AXIS : CNV. EX DECELERATION POW. | <ol style="list-style-type: none"> 1) PSMR: The regenerative discharge amount is too large. 2) α series SVU: The regenerative discharge amount is too large. Alternatively, the regenerative discharge circuit is abnormal. |
| 441 | n AXIS : ABNORMAL CURRENT OFFSET | The digital servo software detected an abnormality in the motor current detection circuit. |
| 442 | n AXIS : CNV. CHARGE FAULT | <ol style="list-style-type: none"> 1) PSM: The spare discharge circuit of the DC link is abnormal. 2) PSMR: The spare discharge circuit of the DC link is abnormal. |
| 443 | n AXIS : CNV. COOLING FAN FAILURE | <ol style="list-style-type: none"> 1) PSM: The internal stirring fan failed. 2) PSMR: The internal stirring fan failed. 3) β series SVU: The internal stirring fan failed. |
| 444 | n AXIS : INV. COOLING FAN FAILURE | SVM: The internal stirring fan failed. |
| 445 | n AXIS : SOFT DISCONNECT ALARM | The digital servo software detected a broken wire in the pulse coder. |
| 446 | n AXIS : HARD DISCONNECT ALARM | A broken wire in the built-in pulse coder was detected by hardware. |
| 447 | n AXIS : HARD DISCONNECT (EXT) | A broken wire in the separate detector was detected by hardware. |
| 448 | n AXIS : UNMATCHED FEEDBACK ALARM | The sign of feedback data from the built-in pulse coder differs from that of feedback data from the separate detector. |
| 449 | n AXIS : INV. IPM ALARM | <ol style="list-style-type: none"> 1) SVM: IPM (intelligent power module) detected an alarm. 2) α series SVU: IPM (intelligent power module) detected an alarm. |
| 453 | n AXIS : SPC SOFT DISCONNECT ALARM | Software disconnection alarm of the α pulse coder. Turn off the power to the CNC, then remove and insert the pulse coder cable. If this alarm is issued again, replace the pulse coder. |
| 456 | ILLEGAL CURRENT LOOP | <p>The current control cycle settings (parameter No. 2004, bit 0 of parameter No. 2003, and bit 0 of parameter No. 2013) are incorrect. Possible problems are as follows.</p> <ul style="list-style-type: none"> – For the two axes whose servo axis numbers (settings of parameter No. 1023) are an odd number followed by an even number (a pair of axes 1 and 2 or axes 5 and 6, for example), a different current control cycle is set for each of the axes. – The requirements for slaves needed for the set current control cycle, including the number, type, and connection method of them, are not satisfied. |
| 457 | ILLEGAL HI HRV (250US) | Use of high-speed HRV is specified although the current control cycle is 200 μ s. |
| 458 | CURRENT LOOP ERROR | The current control cycle setting does not match the actual current control cycle. |
| 459 | HI HRV SETTING ERROR | For the two axes whose servo axis numbers (settings of parameter No. 1023) are an odd number followed by an even number (a pair of axes 1 and 2 or axes 5 and 6, for example), the SVM for one of the axes supports high-speed HRV control but the SVM for the other does not. Refer to the SVM specification. |

| Number | Message | Contents |
|--------|------------------------------------|--|
| 460 | n AXIS : FSSB DISCONNECT | FSSB communication was disconnected suddenly. The possible causes are as follows: 1) The FSSB communication cable was disconnected or broken. 2) The power to the amplifier was turned off suddenly. 3) A low-voltage alarm was issued by the amplifier. |
| 461 | n AXIS : ILLEGAL AMP INTERFACE | The axes of the 2-axis amplifier were assigned to the fast type interface. |
| 462 | n AXIS : SEND CNC DATA FAILED | Because of an FSSB communication error, a slave could not receive correct data. |
| 463 | n AXIS : SEND SLAVE DATA FAILED | Because of an FSSB communication error, the servo system could not receive correct data. |
| 464 | n AXIS : WRITE ID DATA FAILED | An attempt was made to write maintenance information on the amplifier maintenance screen, but it failed. |
| 465 | n AXIS : READ ID DATA FAILED | At power-up, amplifier initial ID information could not be read. |
| 466 | n AXIS : MOTOR/AMP COMBINATION | The maximum current rating for the amplifier does not match that for the motor. |
| 467 | n AXIS : ILLEGAL SETTING OF AXIS | The servo function for the following has not been enabled when an axis occupying a single DSP (corresponding to two ordinary axes) is specified on the axis setting screen. 1. Learning control (bit 5 of parameter No. 2008 = 1) 2. High-speed current loop (bit 0 of parameter No. 2004 = 1) 3. High-speed interface axis (bit 4 of parameter No. 2005 = 1) |
| 468 | HI HRV SETTING ERROR (AMP) | Use of high-speed HRV is specified for a controlled axis of an amplifier which does not support high-speed HRV. |
| 600 | n AXIS : INV. DC LINK OVER CURRENT | DC link current is too large. |
| 601 | n AXIS : INV. RADIATOR FAN FAILURE | The external dissipator stirring fan failed. |
| 602 | n AXIS : INV. OVERHEAT | The servo amplifier was overheated. |
| 603 | n AXIS : INV. IPM ALARM (OH) | The IPM (intelligent power module) detected an overheat alarm. |
| 604 | n AXIS : AMP. COMMUNICATION ERROR | Communication between the SVM and the PSM failed. |
| 605 | n AXIS : CNV. EX. DISCHARGE POW. | PSMR: Regenerative power is too large. |
| 606 | n AXIS : CNV. RADIATOR FAN FAILURE | PSM: The external dissipator stirring fan failed. PSMR: The external dissipator stirring fan failed. |
| 607 | n AXIS : CNV. SINGLE PHASE FAILURE | PSM: Input voltage is in the open-phase condition. PSMR: Input voltage is in the open-phase condition. |

If the hardware on the CNC is suspected to be defective as a result of examination, replace the axis control cards.

See Section 2.4 for explanations about the mounting location of the axis control card.

8.39 SPC ALARMS

For an explanation of the following SPC alarms (serial pulse coder alarms), refer to the Maintenance Manual of your servo motor.

| Number | Message | Contents |
|--------|-----------------------------------|--|
| 360 | n AXIS: ABNORMAL CHECKSUM (INT) | A checksum error occurred in the built-in pulse coder. |
| 361 | n AXIS: ABNORMAL PHASE DATA (INT) | A phase data error occurred in the built-in pulse coder. |
| 364 | n AXIS: SOFT PHASE ALARM (INT) | The digital servo software detected invalid data in the built-in pulse coder. |
| 365 | n AXIS: BROKEN LED (INT) | An LED error occurred in the built-in pulse coder. |
| 366 | n AXIS: PULSE MISS (INT) | A pulse error occurred in the built-in pulse coder. |
| 367 | n AXIS: COUNT MISS (INT) | A count error occurred in the built-in pulse coder. |
| 368 | n AXIS: SERIAL DATA ERROR (INT) | Communication data from the built-in pulse coder cannot be received. |
| 369 | n AXIS: DATA TRANS. ERROR (INT) | A CRC or stop bit error occurred in the communication data being received from the built-in pulse coder. |
| 380 | n AXIS: BROKEN LED (EXT) | An LED error occurred in the separate detector. |
| 381 | n AXIS: ABNORMAL PHASE (EXT LIN) | A phase data error occurred in the separate linear scale. |
| 382 | n AXIS: COUNT MISS (EXT) | A pulse error occurred in the separate detector. |
| 383 | n AXIS: PULSE MISS (EXT) | A count error occurred in the separate detector. |
| 384 | n AXIS: SOFT PHASE ALARM (EXT) | The digital servo software detected invalid data in the separate detector. |
| 385 | n AXIS: SERIAL DATA ERROR (EXT) | Communication data from the separate detector cannot be received. |
| 386 | n AXIS: DATA TRANS. ERROR (EXT) | A CRC or stop bit error occurred in the communication data being received from the separate detector. |
| 387 | n AXIS: ABNORMAL ENCODER (EXT) | An error occurs in the separate detector. For details, contact the manufacturer of the scale. |

8.40 SPINDLE ALARMS

For an explanation of the following spindle alarms, refer to the Maintenance Manual of your servo motor.

| Number | Contents |
|--------------|--|
| 7101 to 7199 | Spindle 1 alarm (SPM display 01 to 99) |
| 7201 to 7299 | Spindle 2 alarm (SPM display 01 to 99) |
| 7301 to 7399 | Spindle 3 alarm (SPM display 01 to 99) |
| 7401 to 7499 | Spindle 4 alarm (SPM display 01 to 99) |

| Number | Contents |
|--------------------------|---|
| 9001 to later: Spindle_n | n-th spindle alarm (SPM display 01 or larger) |

APPENDIX

A ALARM LIST

| | |
|--|-----|
| A.1 LIST OF ALARM CODES (CNC) | 532 |
| A.2 LIST OF ALARMS (PMC) | 569 |
| A.3 ALARM LIST (SERIAL SPINDLE) | 594 |
| A.4 ERROR CODES (SERIAL SPINDLE) | 606 |



CAUTION

The alarm list also contains a description of the alarms for the functions that are invalid for the Series 0i-C and Series 0i Mate-C.

A.1 LIST OF ALARM CODES (CNC)

(1) Program errors /Alarms on program and operation (P/S alarm) (1/2)

| Number | Message | Contents |
|--------|------------------------------------|--|
| 000 | PLEASE TURN OFF POWER | A parameter which requires the power off was input, turn off power. |
| 001 | TH PARITY ALARM | TH alarm (A character with incorrect parity was input). Correct the tape. |
| 002 | TV PARITY ALARM | TV alarm (The number of characters in a block is odd). This alarm will be generated only when the TV check is effective. |
| 003 | TOO MANY DIGITS | Data exceeding the maximum allowable number of digits was input. (Refer to the item of max. programmable dimensions.) |
| 004 | ADDRESS NOT FOUND | A numeral or the sign “-” was input without an address at the beginning of a block. Modify the program . |
| 005 | NO DATA AFTER ADDRESS | The address was not followed by the appropriate data but was followed by another address or EOB code. Modify the program. |
| 006 | ILLEGAL USE OF NEGATIVE SIGN | Sign “-” input error (Sign “-” was input after an address with which it cannot be used. Or two or more “-” signs were input.) Modify the program. |
| 007 | ILLEGAL USE OF DECIMAL POINT | Decimal point “.” input error (A decimal point was input after an address with which it can not be used. Or two decimal points were input.) Modify the program. |
| 009 | ILLEGAL ADDRESS INPUT | Unusable character was input in significant area. Modify the program. |
| 010 | IMPROPER G-CODE | An unusable G code or G code corresponding to the function not provided is specified. Modify the program. |
| 011 | NO FEEDRATE COMMANDED | Feedrate was not commanded to a cutting feed or the feedrate was inadequate. Modify the program. |
| 014 | CAN NOT COMMAND G95 (M series) | A synchronous feed is specified without the option for threading / synchronous feed. |
| | ILLEGAL LEAD COMMAND (T series) | In variable lead threading, the lead incremental and decremental outputted by address K exceed the maximum command value or a command such that the lead becomes a negative value is given. Modify the program. |
| 015 | TOO MANY AXES COMMANDED (M series) | An attempt was made to move the machine along the axes, but the number of the axes exceeded the specified number of axes controlled simultaneously. Modify the program. |
| | TOO MANY AXES COMMANDED (T series) | An attempt has been made to move the tool along more than the maximum number of simultaneously controlled axes. Alternatively, no axis movement command or an axis movement command for two or more axes has been specified in the block containing the command for skip using the torque limit signal (G31 P99/98). The command must be accompanied with an axis movement command for a single axis, in the same block. |
| 020 | OVER TOLERANCE OF RADIUS | In circular interpolation (G02 or G03), difference of the distance between the start point and the center of an arc and that between the end point and the center of the arc exceeded the value specified in parameter No. 3410. |
| 021 | ILLEGAL PLANE AXIS COMMANDED | An axis not included in the selected plane (by using G17, G18, G19) was commanded in circular interpolation. Modify the program. |
| 022 | NO CIRCLE RADIUS | The command for circular interpolation lacks arc radius R or coordinate I, J, or K of the distance between the start point to the center of the arc. |

| Number | Message | Contents |
|--------|---|--|
| 023 | ILLEGAL RADIUS COMMAND (T series) | In circular interpolation by radius designation, negative value was commanded for address R. Modify the program. |
| 025 | CANNOT COMMAND F0 IN G02/G03 (M series) | F0 (fast feed) was instructed by F1 –digit column feed in circular interpolation. Modify the program. |
| 027 | NO AXES COMMANDED IN G43/G44 (M series) | No axis is specified in G43 and G44 blocks for the tool length offset type C. Offset is not canceled but another axis is offset for the tool length offset type C. Modify the program. |
| 028 | ILLEGAL PLANE SELECT | In the plane selection command, two or more axes in the same direction are commanded. Modify the program. |
| 029 | ILLEGAL OFFSET VALUE (M series) | The offset values specified by H code is too large. Modify the program. |
| | ILLEGAL OFFSET VALUE (T series) | The offset values specified by T code is too large. Modify the program. |
| 030 | ILLEGAL OFFSET NUMBER (M series) | The offset number specified by D/H code for tool length offset, cutter compensation, or three-dimensional tool offset is too large. Alternatively, the number of an additional workpiece coordinate system specified with the P code is too large. Modify the program. |
| | ILLEGAL OFFSET NUMBER (T series) | The offset number in T function specified for tool offset is too large. Modify the program. |
| 031 | ILLEGAL P COMMAND IN G10 | In setting an offset amount by G10, the offset number following address P was excessive or it was not specified. Modify the program. |
| 032 | ILLEGAL OFFSET VALUE IN G10 | In setting an offset amount by G10 or in writing an offset amount by system variables, the offset amount was excessive. |
| 033 | NO SOLUTION AT CRC (M series) | A point of intersection cannot be determined for cutter compensation. Modify the program. |
| | NO SOLUTION AT CRC (T series) | A point of intersection cannot be determined for tool nose radius compensation. Modify the program. |
| 034 | NO CIRC ALLOWED IN ST-UP /EXT BLK (M series) | The start up or cancel was going to be performed in the G02 or G03 mode in cutter compensation C. Modify the program. |
| | NO CIRC ALLOWED IN ST-UP /EXT BLK (T series) | The start up or cancel was going to be performed in the G02 or G03 mode in tool nose radius compensation. Modify the program. |
| 035 | CAN NOT COMMANDED G39 (M series) | G39 is commanded in cutter compensation B cancel mode or on the plane other than offset plane. Modify the program. |
| | CAN NOT COMMANDED G31 (T series) | Skip cutting (G31) was specified in tool nose radius compensation mode. Modify the program. |
| 036 | CAN NOT COMMANDED G31 (M series) | Skip cutting (G31) was specified in cutter compensation mode. Modify the program. |
| 037 | CAN NOT CHANGE PLANE IN CRC (M series) | G40 is commanded on the plane other than offset plane in cutter compensation B. The plane selected by using G17, G18 or G19 is changed in cutter compensation C mode. Modify the program. |
| | CAN NOT CHANGE PLANE IN NRC (T series) | The offset plane is switched in tool nose radius compensation. Modify the program. |
| 038 | INTERFERENCE IN CIRCULAR BLOCK (M series) | Overcutting will occur in cutter compensation C because the arc start point or end point coincides with the arc center. Modify the program. |
| | INTERFERENCE IN CIRCULAR BLOCK (T series) | Overcutting will occur in tool nose radius compensation because the arc start point or end point coincides with the arc center. Modify the program. |

| Number | Message | Contents |
|--------|---|---|
| 039 | CHF/CNR NOT ALLOWED IN NRC (T series) | Chamfering or corner R was specified with a start-up, a cancel, or switching between G41 and G42 in tool nose radius compensation. The program may cause overcutting to occur in chamfering or corner R. Modify the program. |
| 040 | INTERFERENCE IN G90/G94 BLOCK (T series) | Overcutting will occur in tool nose radius compensation in canned cycle G90 or G94. Modify the program. |
| 041 | INTERFERENCE IN CRC (M series) | Overcutting will occur in cutter compensation C. Two or more blocks are consecutively specified in which functions such as the auxiliary function and dwell functions are performed without movement in the cutter compensation mode. Modify the program. |
| | INTERFERENCE IN NRC (T series) | Overcutting will occur in tool nose radius compensation. Modify the program. |
| 042 | G45/G48 NOT ALLOWED IN CRC (M series) | Tool offset (G45 to G48) is commanded in cutter compensation. Modify the program. |
| 044 | G27-G30 NOT ALLOWED IN FIXED CYC (M series) | One of G27 to G30 is commanded in canned cycle mode. Modify the program. |
| 045 | ADDRESS Q NOT FOUND (G73/G83) (M series) | In canned cycle G73/G83, the depth of each cut (Q) is not specified. Alternatively, Q0 is specified. Correct the program. |
| 046 | ILLEGAL REFERENCE RETURN COMMAND | Other than P2, P3 and P4 are commanded for 2nd, 3rd and 4th reference position return command. |
| 047 | ILLEGAL AXIS SELECT | Two or more parallel axes (in parallel with a basic axis) have been specified upon start-up of three-dimensional tool compensation or three-dimensional coordinate conversion. |
| 048 | BASIC 3 AXIS NOT FOUND | Start-up of three-dimensional tool compensation or three-dimensional coordinate conversion has been attempted, but the three basic axes used when Xp, Yp, or Zp is omitted are not set in parameter No. 1022. |
| 049 | ILLEGAL OPERATION (G68/G69) (M series) | The commands for three-dimensional coordinate conversion (G68, G69) and tool length compensation (G43, G44, G45) are not nested. Modify the program. |
| 050 | CHF/CNR NOT ALLOWED IN THRD BLK (M series) | Optional chamfering or corner R is commanded in the thread cutting block. Modify the program. |
| | CHF/CNR NOT ALLOWED IN THRD BLK(T series) | Chamfering or corner R is commanded in the thread cutting block. Modify the program. |
| 051 | MISSING MOVE AFTER CHF/CNR (M series) | Improper movement or the move distance was specified in the block next to the optional chamfering or corner R block. Modify the program. |
| | MISSING MOVE AFTER CHF/CNR (T series) | Improper movement or the move distance was specified in the block next to the chamfering or corner R block. Modify the program. |
| 052 | CODE IS NOT G01 AFTER CHF/CNR (M series) | The block next to the chamfering or corner R block is not G01, G02 or G03. Modify the program. |
| | CODE IS NOT G01 AFTER CHF/CNR (T series) | The block next to the chamfering or corner R block is not G01. Modify the program. |
| 053 | TOO MANY ADDRESS COMMANDS (M series) | For systems without the arbitrary angle chamfering or corner R cutting, a comma was specified. For systems with this feature, a comma was followed by something other than R or C. Correct the program. |
| | TOO MANY ADDRESS COMMANDS (T series) | In the chamfering and corner R commands, two or more of I, K and R are specified. Otherwise, the character after a comma(",") is not C or R in direct drawing dimensions programming. Modify the program. |
| 055 | MISSING MOVE VALUE IN CHF/CNR (M series) | In the arbitrary angle chamfering or corner R block, the move distance is less than chamfer or corner R amount. |

| Number | Message | Contents |
|--------|--|--|
| 056 | NO END POINT & ANGLE IN CHF/ CNR (T series) | Neither the end point nor angle is specified in the command for the block next to that for which only the angle is specified (A). In the chamfering command, I(K) is commanded for the X(Z) axis. |
| 057 | NO SOLUTION OF BLOCK END (T series) | Block end point is not calculated correctly in direct dimension drawing programming. |
| 058 | END POINT NOT FOUND (M series) | In a arbitrary angle chamfering or corner R cutting block, a specified axis is not in the selected plane. Correct the program. |
| | END POINT NOT FOUND (T series) | Block end point is not found in direct dimension drawing programming. |
| 059 | PROGRAM NUMBER NOT FOUND | In an external program number search, a specified program number was not found. Otherwise, a program specified for searching is being edited in background processing. Alternatively, the program with the program number specified in a one-touch macro call is not found in memory. Check the program number and external signal. Or discontinue the background editing. |
| 060 | SEQUENCE NUMBER NOT FOUND | Commanded sequence number was not found in the sequence number search. Check the sequence number. |
| 061 | ADDRESS P/Q NOT FOUND IN G70-G73 (T series) | Address P or Q is not specified in G70, G71, G72, or G73 command. Modify the program. |
| 062 | ILLEGAL COMMAND IN G71-G76 (T series) | <ol style="list-style-type: none"> 1. The depth of cut in G71 or G72 is zero or negative value. 2. The repetitive count in G73 is zero or negative value. 3. the negative value is specified to Δi or Δk is zero in G74 or G75. 4. A value other than zero is specified to address U or W though Δi or Δk is zero in G74 or G75. 5. A negative value is specified to Δd, though the relief direction in G74 or G75 is determined. 6. Zero or a negative value is specified to the height of thread or depth of cut of first time in G76. 7. The specified minimum depth of cut in G76 is greater than the height of thread. 8. An unusable angle of tool tip is specified in G76. Modify the program. |
| 063 | SEQUENCE NUMBER NOT FOUND (T series) | The sequence number specified by address P in G70, G71, G72, or G73 command cannot be searched. Modify the program. |
| 064 | SHAPE PROGRAM NOT MONOTONOUSLY (T series) | A target shape which cannot be made by monotonic machining was specified in a repetitive canned cycle (G71 or G72). |
| 065 | ILLEGAL COMMAND IN G71-G73 (T series) | <ol style="list-style-type: none"> 1. G00 or G01 is not commanded at the block with the sequence number which is specified by address P in G71, G72, or G73 command. 2. Address Z(W) or X(U) was commanded in the block with a sequence number which is specified by address P in G71 or G72, respectively. Modify the program. |
| 066 | IMPROPER G-CODE IN G71-G73 (T series) | An unallowable G code was commanded between two blocks specified by address P in G71, G72, or G73. Modify the program. |
| 067 | CAN NOT ERROR IN MDI MODE (T series) | G70, G71, G72, or G73 command with address P and Q. Modify the program. |
| 069 | FORMAT ERROR IN G70-G73 (T series) | The final move command in the blocks specified by P and Q of G70, G71, G72, and G73 ended with chamfering or corner R. Modify the program. |
| 070 | NO PROGRAM SPACE IN MEMORY | The memory area is insufficient. Delete any unnecessary programs, then retry. |

| Number | Message | Contents |
|--------|--|--|
| 071 | DATA NOT FOUND | The address to be searched was not found. Or the program with specified program number was not found in program number search. Check the data. |
| 072 | TOO MANY PROGRAMS | The number of programs to be stored exceeded 63 (basic), 125 (option), 200 (option), 400 (option) or 1000 (option). Delete unnecessary programs and execute program registration again. |
| 073 | PROGRAM NUMBER ALREADY IN USE | The commanded program number has already been used. Change the program number or delete unnecessary programs and execute program registration again. |
| 074 | ILLEGAL PROGRAM NUMBER | The program number is other than 1 to 9999. Modify the program number. |
| 075 | PROTECT | An attempt was made to register a program whose number was protected. |
| 076 | ADDRESS P NOT DEFINED | Address P (program number) was not commanded in the block which includes an M98, G65, or G66 command. Modify the program. |
| 077 | SUB PROGRAM NESTING ERROR | The subprogram was called in five folds. Modify the program. |
| 078 | NUMBER NOT FOUND | A program number or a sequence number which was specified by address P in the block which includes an M98, M99, M65 or G66 was not found. The sequence number specified by a GOTO statement was not found. Otherwise, a called program is being edited in background processing. Correct the program, or discontinue the background editing. |
| 079 | PROGRAM VERIFY ERROR | In memory or program collation, a program in memory does not agree with that read from an external I/O device. Check both the programs in memory and those from the external device. |
| 080 | G37 ARRIVAL SIGNAL NOT ASSERTED (M series) | In the automatic tool length measurement function (G37), the measurement position reach signal (XAE, YAE, or ZAE) is not turned on within an area specified in parameter 6254 6255 (value ϵ). This is due to a setting or operator error. |
| | G37 ARRIVAL SIGNAL NOT ASSERTED (T series) | In the automatic tool compensation function (G36, G37), the measurement position reach signal (XAE or ZAE) is not turned on within an area specified in parameter 6254 (value ϵ). This is due to a setting or operator error. |
| 081 | OFFSET NUMBER NOT FOUND IN G37 (M series) | Tool length automatic measurement (G37) was specified without a H code. (Automatic tool length measurement function) Modify the program. |
| | OFFSET NUMBER NOT FOUND IN G37 (T series) | Automatic tool compensation (G36, G37) was specified without a T code. (Automatic tool compensation function) Modify the program. |
| 082 | H-CODE NOT ALLOWED IN G37 (M series) | H code and automatic tool compensation (G37) were specified in the same block. (Automatic tool length measurement function) Modify the program. |
| | T-CODE NOT ALLOWED IN G37 (T series) | T code and automatic tool compensation (G36, G37) were specified in the same block. (Automatic tool compensation function) Modify the program. |
| 083 | ILLEGAL AXIS COMMAND IN G37 (M series) | In automatic tool length measurement, an invalid axis was specified or the command is incremental. Modify the program. |
| | ILLEGAL AXIS COMMAND IN G37 (T series) | In automatic tool compensation (G36, G37), an invalid axis was specified or the command is incremental. Modify the program. |
| 085 | COMMUNICATION ERROR | When entering data in the memory by using Reader / Puncher interface, an overrun, parity or framing error was generated. The number of bits of input data or setting of baud rate or specification No. of I/O unit is incorrect. |

| Number | Message | Contents |
|--------|-------------------------------------|--|
| 086 | DR SIGNAL OFF | When entering data in the memory by using Reader / Puncher interface, the ready signal (DR) of reader / puncher was turned off. Power supply of I/O unit is off or cable is not connected or a P.C.B. is defective. |
| 087 | BUFFER OVERFLOW | When entering data in the memory by using Reader / Puncher interface, though the read terminate command is specified, input is not interrupted after 10 characters read. I/O unit or P.C.B. is defective. |
| 088 | LAN FILE TRANS ERROR (CHANNEL-1) | File data transfer via OSI-ETHERNET has been stopped due to a transfer error. |
| 089 | LAN FILE TRANS ERROR (CHANNEL-2) | File data transfer via OSI-ETHERNET has been stopped due to a transfer error. |
| 090 | REFERENCE RETURN INCOMPLETE | <ol style="list-style-type: none"> 1. The reference position return cannot be performed normally because the reference position return start point is too close to the reference position or the speed is too slow. Separate the start point far enough from the reference position, or specify a sufficiently fast speed for reference position return. 2. During reference position return with the absolute-position detector, if this alarm occurs even though condition 1 is satisfied, do the following: After turning the servo motor for the axis at least one turn, turn the power off and then on again. Then perform reference position return. |
| 091 | REFERENCE RETURN INCOMPLETE | Manual reference position return cannot be performed when automatic operation is halted. |
| 092 | AXES NOT ON THE REFERENCE POINT | The commanded axis by G27 (Reference position return check) did not return to the reference position. |
| 094 | P TYPE NOT ALLOWED (COORD CHG) | P type cannot be specified when the program is restarted. (After the automatic operation was interrupted, the coordinate system setting operation was performed.) Perform the correct operation according to the operator's manual. |
| 095 | P TYPE NOT ALLOWED (EXT OFS CHG) | P type cannot be specified when the program is restarted. (After the automatic operation was interrupted, the external workpiece offset amount changed.) Perform the correct operation according to the operator's manual. |
| 096 | P TYPE NOT ALLOWED (WRK OFS CHG) | P type cannot be specified when the program is restarted. (After the automatic operation was interrupted, the workpiece offset amount changed.) Perform the correct operation according to the operator's manual. |
| 097 | P TYPE NOT ALLOWED (AUTO EXEC) | P type cannot be directed when the program is restarted. (After power ON, after emergency stop or P / S 94 to 97 reset, no automatic operation is performed.) Perform automatic operation. |
| 098 | G28 FOUND IN SEQUENCE RETURN | A command of the program restart was specified without the reference position return operation after power ON or emergency stop, and G28 was found during search. Perform the reference position return. |
| 099 | MDI EXEC NOT ALLOWED AFT. SEARCH | After completion of search in program restart, a move command is given with MDI. Move axis before a move command or don't interrupt MDI operation. |
| 100 | PARAMETER WRITE ENABLE | On the PARAMETER (SETTING) screen, PWE (parameter writing enabled) is set to 1. Set it to 0, then reset the system. |
| 101 | PLEASE CLEAR MEMORY | The power turned off while rewriting the memory by program edit operation. If this alarm has occurred, press <RESET> while pressing <PROG>, and only the program being edited will be deleted. Register the deleted program. |

| Number | Message | Contents |
|--------|-----------------------------------|---|
| 109 | FORMAT ERROR IN G08 | A value other than 0 or 1 was specified after P in the G08 code, or no value was specified. |
| 110 | DATA OVERFLOW | The absolute value of fixed decimal point display data exceeds the allowable range. Modify the program. |
| 111 | CALCULATED DATA OVERFLOW | The result of calculation turns out to be invalid, an alarm No.111 is issued. -10^{47} to -10^{-29} , 0, 10^{-29} to 10^{47} Modify the program. |
| 112 | DIVIDED BY ZERO | Division by zero was specified. (including $\tan 90^\circ$) Modify the program. |
| 113 | IMPROPER COMMAND | A function which cannot be used in custom macro is commanded. Modify the program. |
| 114 | FORMAT ERROR IN MACRO | There is an error in other formats than <Formula>. Modify the program. |
| 115 | ILLEGAL VARIABLE NUMBER | A value not defined as a variable number is designated in the custom macro or in high-speed cycle machining. The header contents are improper. This alarm is given in the following cases: High speed cycle machining 1. The header corresponding to the specified machining cycle number called is not found. 2. The cycle connection data value is out of the allowable range (0 – 999). 3. The number of data in the header is out of the allowable range (0 – 32767). 4. The start data variable number of executable format data is out of the allowable range (#20000 – #85535). 5. The last storing data variable number of executable format data is out of the allowable range (#85535). 6. The storing start data variable number of executable format data is overlapped with the variable number used in the header. Modify the program. |
| 116 | WRITE PROTECTED VARIABLE | The left side of substitution statement is a variable whose substitution is inhibited. Modify the program. |
| 118 | PARENTHESIS NESTING ERROR | The nesting of bracket exceeds the upper limit (quintuple). Modify the program. |
| 119 | ILLEGAL ARGUMENT | The SQRT argument is negative. Or BCD argument is negative, and other values than 0 to 9 are present on each line of BIN argument. Modify the program. |
| 122 | FOUR FOLD MACRO MODAL-CALL | The macro modal call is specified four fold. Modify the program. |
| 123 | CAN NOT USE MACRO COMMAND IN DNC | Macro control command is used during DNC operation. Modify the program. |
| 124 | MISSING END STATEMENT | DO – END does not correspond to 1 : 1. Modify the program. |
| 125 | FORMAT ERROR IN MACRO | <Formula> format is erroneous. Modify the program. |
| 126 | ILLEGAL LOOP NUMBER | In DO n, $1 \leq n \leq 3$ is not established. Modify the program. |
| 127 | NC, MACRO STATEMENT IN SAME BLOCK | NC and custom macro commands coexist. Modify the program. |
| 128 | ILLEGAL MACRO SEQUENCE NUMBER | The sequence number specified in the branch command was not 0 to 9999. Or, it cannot be searched. Modify the program. |

| Number | Message | Contents |
|--------|--|---|
| 129 | ILLEGAL ARGUMENT ADDRESS | An address which is not allowed in <Argument Designation > is used. Modify the program. |
| 130 | ILLEGAL AXIS OPERATION | An axis control command was given by PMC to an axis controlled by CNC. Or an axis control command was given by CNC to an axis controlled by PMC. Modify the program. |
| 131 | TOO MANY EXTERNAL ALARM MESSAGES | Five or more alarms have generated in external alarm message. Consult the PMC ladder diagram to find the cause. |
| 132 | ALARM NUMBER NOT FOUND | No alarm No. concerned exists in external alarm message clear. Check the PMC ladder diagram. |
| 133 | ILLEGAL DATA IN EXT. ALARM MSG | Small section data is erroneous in external alarm message or external operator message. Check the PMC ladder diagram. |
| 135 | ILLEGAL ANGLE COMMAND (M series) | The index table indexing positioning angle was instructed in other than an integral multiple of the value of the minimum angle. Modify the program. |
| | SPINDLE ORIENTATION PLEASE (T series) | Without any spindle orientation , an attempt was made for spindle indexing. Perform spindle orientation. |
| 136 | ILLEGAL AXIS COMMAND (M series) | In index table indexing. Another control axis was instructed together with the B axis. Modify the program. |
| | C/H-CODE & MOVE CMD IN SAME BLK. (T series) | A move command of other axes was specified to the same block as spindle indexing addresses C, H. Modify the program. |
| 137 | M-CODE & MOVE CMD IN SAME BLK. | A move command of other axes was specified to the same block as M-code related to spindle indexing. Modify the program. |
| 138 | SUPERIMPOSED DATA OVERFLOW | The total distribution amount of the CNC and PMC is too large during superimposed control of the extended functions for PMC axis control. |
| 139 | CAN NOT CHANGE PMC CONTROL AXIS | An axis is selected in commanding by PMC axis control. Modify the program. |
| 140 | BP/S ALARM | Background editing alarm. See page 545. |
| 141 | CAN NOT COMMAND G51 IN CRC (M series) | G51 (Scaling ON) is commanded in the tool offset mode. Modify the program. |
| 142 | ILLEGAL SCALE RATE (M series) | Scaling magnification is commanded in other than 1 – 999999. Correct the scaling magnification setting (G51 P _p or parameter 5411 or 5421). |
| 143 | SCALED MOTION DATA OVERFLOW (M series) | The scaling results, move distance, coordinate value and circular radius exceed the maximum command value. Correct the program or scaling magnification. |
| 144 | ILLEGAL PLANE SELECTED (M series) | The coordinate rotation plane and arc or cutter compensation C plane must be the same. Modify the program. |
| 145 | ILLEGAL CONDITIONS IN POLAR COORDINATE INTERPOLATION | The conditions are incorrect when the polar coordinate interpolation starts or it is canceled. 1) In modes other than G40, G12.1/G13.1 was specified. 2) An error is found in the plane selection. Parameters No. 5460 and No. 5461 are incorrectly specified. Modify the value of program or parameter. |
| 146 | IMPROPER G CODE | G codes which cannot be specified in the polar coordinate interpolation mode was specified. See section II-4.4 and modify the program. |
| 148 | ILLEGAL SETTING DATA (M series) | Automatic corner override deceleration rate is out of the settable range of judgement angle. Modify the parameters (No.1710 to No.1714) |
| 150 | ILLEGAL TOOL GROUP NUMBER | Tool Group No. exceeds the maximum allowable value. Modify the program. |

| Number | Message | Contents |
|--------|---|---|
| 151 | TOOL GROUP NUMBER NOT FOUND | The tool group commanded in the machining program is not set. Modify the value of program or parameter. |
| 152 | NO SPACE FOR TOOL ENTRY | The number of tools within one group exceeds the maximum value registerable. Modify the number of tools. |
| 153 | T-CODE NOT FOUND | In tool life data registration, a T code was not specified where one should be. Correct the program. |
| 154 | NOT USING TOOL IN LIFE GROUP (M series) | When the group is not commanded, H99 or D99 was commanded. Correct the program. |
| 155 | ILLEGAL T-CODE IN M06 (M series) | In the machining program, M06 and T code in the same block do not correspond to the group in use. Correct the program. |
| | ILLEGAL T-CODE IN M06 (T series) | Group No.ΔΔ which is specified with TΔΔ 88 of the machining program do not included in the tool group in use. Correct the program. |
| 156 | P/L COMMAND NOT FOUND | P and L commands are missing at the head of program in which the tool group is set. Correct the program. |
| 157 | TOO MANY TOOL GROUPS | The number of tool groups to be set exceeds the maximum allowable value. (See parameter No. 6800 bit 0 and 1) Modify the program. |
| 158 | ILLEGAL TOOL LIFE DATA | The tool life to be set is too excessive. Modify the setting value. |
| 159 | TOOL DATA SETTING INCOMPLETE | During executing a life data setting program, power was turned off. Set again. |
| 160 | MISMATCH WAITING M-CODE (T series (At two-path)) | Diffrent M code is commanded in heads 1 and 2 as waiting M code. Modify the program. |
| | MISMATCH WAITING M-CODE (T series (At three-path)) | 1) Although the same P command is specified, the waiting M codes do not match. 2) Although the waiting M codes match, the P commands do not match. 3) Two-path wait and three-path wait are specified simultaneously. Modify the program. |
| | G72.1 NESTING ERROR (M series) | A subprogram which performs rotational copy with G72.1 contains another G72.1 command. |
| 161 | ILLEGAL P OF WAITING M-CODE (T series (three-path control)) | 1) The value of address P is a negative value, 1, 2, 4, or a value not smaller than 8. 2) The value specified in P is not consistent with the system configuration. Modify the program. |
| | G72.1 NESTING ERROR (M series) | A subprogram which performs parallel copy with G72.2 contains another G72.2 command. |
| 163 | COMMAND G68/G69 INDEPENDENTLY (T series (At two-path)) | G68 and G69 are not independently commanded in balance cut. Modify the program. |
| 169 | ILLEGAL TOOL GEOMETRY DATA (At two-path) | Incorrect tool figure data in interference check. Set correct data, or select correct tool figure data. |
| 175 | ILLEGAL G107 COMMAND | Conditions when performing circular interpolation start or cancel not correct. To change the mode to the cylindrical interpolation mode, specify the command in a format of "G07.1 rotation-axis name radius of cylinder." |

| Number | Message | Contents |
|--------|--|---|
| 176 | IMPROPER G-CODE IN G107 (M series) | Any of the following G codes which cannot be specified in the cylindrical interpolation mode was specified. 1) G codes for positioning: G28,, G73, G74, G76, G81 – G89, including the codes specifying the rapid traverse cycle 2) G codes for setting a coordinate system: G52,G92, 3) G code for selecting coordinate system: G53 G54–G59 Modify the program. |
| | IMPROPER G-CODE IN G107 (T series) | Any of the following G codes which cannot be specified in the cylindrical interpolation mode was specified. 1) G codes for positioning: G28, G76, G81 – G89, including the codes specifying the rapid traverse cycle 2) G codes for setting a coordinate system: G50, G52 3) G code for selecting coordinate system: G53 G54–G59 Modify the program. |
| 181 | FORMAT ERROR IN G81 BLOCK (Hobbing machine, EGB) (M series) | G81 block format error (hobbing machine) 1) T (number of teeth) has not been instructed. 2) Data outside the command range was instructed by either T, L, Q or P. 3) An overflow occurred in synchronization coefficient calculation. Modify the program. |
| 182 | G81 NOT COMMANDED (Hobbing machine) (M series) | G83 (C axis servo lag quantity offset) was instructed though synchronization by G81 has not been instructed. Correct the program. (hobbing machine) |
| 183 | DUPLICATE G83 (COMMANDS) (Hobbing machine) (M series) | G83 was instructed before canceled by G82 after compensating for the C axis servo lag quantity by G83. (hobbing machine) |
| 184 | ILLEGAL COMMAND IN G81 (Hobbing machine, EGB) (M series) | A command not to be instructed during synchronization by G81 was instructed. (hobbing machine) 1) A C axis command by G00, G27, G28, G29, G30, etc. was instructed. 2) Inch/Metric switching by G20, G21 was instructed. |
| 185 | RETURN TO REFERENCE POINT (Hobbing machine) (M series) | G81 was instructed without performing reference position return after power on or emergency stop. (hobbing machine) Perform reference position return. |
| 186 | PARAMETER SETTING ERROR (Hobbing machine, EGB) (M series) | Parameter error regarding G81 (hobbing machine) 1) The C axis has not been set to be a rotary axis. 2) A hob axis and position coder gear ratio setting error Modify the parameter. |
| 187 | HOB COMMAND IS NOT ALLOWED | Error in the modal state when G81.4 or G81 is specified 1. The canned cycle mode (G81 to G89) is set. 2. The thread cutting mode is set. 3. The C-axis is under synchronous, composite, or superimposed control. |
| 190 | ILLEGAL AXIS SELECT | In the constant surface speed control, the axis specification is wrong. (See parameter No. 3770.) The specified axis command (P) contains an illegal value. Correct the program. |
| 194 | SPINDLE COMMAND IN SYNCHRO-MODE | A contour control mode, spindle positioning (Cs-axis control) mode, or rigid tapping mode was specified during the serial spindle synchronous control mode. Correct the program so that the serial spindle synchronous control mode is released in advance. |

| Number | Message | Contents |
|--------|--|--|
| 197 | C-AXIS COMMANDED IN SPINDLE MODE | The program specified a movement along the Cs-axis when the signal CON(DGN=G027#7) was off. Correct the program, or consult the PMC ladder diagram to find the reason the signal is not turned on. |
| 199 | MACRO WORD UNDEFINED | Undefined macro word was used. Modify the custom macro. |
| 200 | ILLEGAL S CODE COMMAND | In the rigid tap, an S value is out of the range or is not specified. Modify the program. |
| 201 | FEEDRATE NOT FOUND IN RIGID TAP | In the rigid tap, no F value is specified. Correct the program. |
| 202 | POSITION LSI OVERFLOW | In the rigid tap, spindle distribution value is too large. (System error) |
| 203 | PROGRAMMISS AT RIGID TAPPING | In the rigid tap, position for a rigid M code (M29) or an S command is incorrect. Modify the program. |
| 204 | ILLEGAL AXIS OPERATION | In the rigid tap, an axis movement is specified between the rigid M code (M29) block and G84 or G74 for M series (G84 or G88 for T series) block. Modify the program. |
| 205 | RIGID MODE DI SIGNAL OFF | 1. Although a rigid M code (M29) is specified in rigid tapping, the rigid mode DI signal (DGN G061.0) is not ON during execution of the G84 (G88) block. 2. In a system with the multi-spindle option, the spindle used for rigid tapping is not selected (by DI signal G27#0 and #1, or G61#4 and #5). Check the PMC ladder diagram to find the reason why the DI signal is not turned on. |
| 206 | CAN NOT CHANGE PLANE (M series) | Plane changeover was instructed in the rigid mode. Correct the program. |
| 207 | RIGID DATA MISMATCH | The specified distance was too short or too long in rigid tapping. |
| 210 | CAN NOT COMAND M198/M199 | M98 and M99 are executed in the schedule operation. M198 is executed in the DNC operation. Modify the program. 1) The execution of an M198 or M99 command was attempted during scheduled operation. Alternatively, the execution of an M198 command was attempted during DNC operation. Correct the program. The execution of an M99 command was attempted by an interrupt macro during pocket machining in a multiple repetitive canned cycle. |
| 211 | G31 (HIGH) NOT ALLOWED IN G99 (T series) | G31 is commanded in the per revolution command when the high-speed skip option is provided. Modify the program. |
| 212 | ILLEGAL PLANE SELECT (M series) | The arbitrary angle chamfering or a corner R is commanded or the plane including an additional axis. Correct the program. |
| | ILLEGAL PLANE SELECT (T series) | The direct drawing dimensions programming is commanded for the plane other than the Z-X plane. Correct the program. |
| 213 | ILLEGAL COMMAND IN SYNCHRO-MODE (M series) | Movement is commanded for the axis to be synchronously controlled. Any of the following alarms occurred in the operation with the simple synchronization control. 1) The program issued the move command to the slave axis. 2) The program issued the manual continuous feed/manual handle feed/incremental feed command to the slave axis. 3) The program issued the automatic reference position return command without specifying the manual reference position return after the power was turned on. 4) The difference between the position error amount of the master and slave axes exceeded the value specified in parameter NO.8313. |
| | ILLEGAL COMMAND IN SYNCHRO-MODE (T series) | A move command has been specified for an axis subject to synchronous control. |

| Number | Message | Contents |
|--------|--|---|
| 214 | ILLEGAL COMMAND IN SYNCHRO-MODE | Coordinate system is set or tool compensation of the shift type is executed in the synchronous control. Correct the program. |
| 217 | DUPLICATE G51.2 (COMMANDS) (T series) | G51.2/G251 is further commanded in the G51.2/G251 mode. Modify the program. |
| 218 | NOT FOUND P/Q COMMAND IN G251 (T series) | P or Q is not commanded in the G251 block, or the command value is out of the range. Modify the program. |
| 219 | COMMAND G250/G251 INDEPENDENTLY (T series) | G251 and G250 are not independent blocks. |
| 220 | ILLEGAL COMMAND IN SYNCHR-MODE (T series) | In the synchronous operation, movement is commanded by the NC program or PMC axis control interface for the synchronous axis. |
| 221 | ILLEGAL COMMAND IN SYNCHR-MODE (T series) | Polygon machining synchronous operation and axis control or balance cutting are executed at a time. Modify the program. |
| 222 | DNC OP. NOT ALLOWED IN BG.-EDIT (M series) | Input and output are executed at a time in the background edition. Execute a correct operation. |
| 224 | RETURN TO REFERENCE POINT (M series) | Reference position return has not been performed before the automatic operation starts. Perform reference position return only when bit 0 of parameter 1005 is 0. |
| | TURN TO REFERENCE POINT (T series) | Reference position return is necessary before cycle start. |
| 225 | SYNCHRONOUS/MIXED CONTROL ERROR (T series (At two-path)) | This alarm is generated in the following circumstances. (Searched for during synchronous and mixed control command. <ol style="list-style-type: none"> 1 When there is a mistake in axis number parameter (No. 1023) setting. 2 When there is a mistake in control commanded. During hobbing synchronization, a command to bring the C-axis under synchronous, composite, or superimposed control is made. Modify the program or the parameter. |
| 226 | ILLEGAL COMMAND IN SYNCHRO-MODE (T series (At two-path)) | A travel command has been sent to the axis being synchronized in synchronous mode. Modify the program or the parameter. |
| 229 | CAN NOT KEEP SYNCHRO-STATE (T series) | This alarm is generated in the following circumstances. <ol style="list-style-type: none"> 1 When the synchro/mixed state could not be kept due to system overload. 2 The above condition occurred in CMC devices (hardware) and synchro-state could not be kept. (This alarm is not generated in normal use conditions.) |
| 230 | R CODE NOT FOUND (Grinding machine) (M series) | The infeed quantity R has not been instructed for the G161 block. Or the R command value is negative. Correct the program. |
| 231 | ILLEGAL FORMAT IN G10 OR L50 | Any of the following errors occurred in the specified format at the programmable-parameter input. <ol style="list-style-type: none"> 1 Address N or R was not entered. 2 A number not specified for a parameter was entered. 3 The axis number was too large. 4 An axis number was not specified in the axis-type parameter. 5 An axis number was specified in the parameter which is not an axis type. Correct the program. 6 In the locked state set by the password function, an attempt was made to set bit 4 (NE9) of parameter No. 3204 to 0 or change the contents of parameter No. 3210. 7 An attempt was made to change a program encryption parameter (parameter No. 3220 to 3223). |

| Number | Message | Contents |
|--------|---|--|
| 232 | TOO MANY HELICAL AXIS COMMANDS | Three or more axes (in the normal direction control mode (M series) two or more axes) were specified as helical axes in the helical interpolation mode. |
| 233 | DEVICE BUSY | When an attempt was made to use a unit such as that connected via the RS-232-C interface, other users were using it. |
| 239 | BP/S ALARM | While punching was being performed with the function for controlling external I/O units, background editing was performed. |
| 240 | BP/S ALARM | Background editing was performed during MDI operation. |
| 241 | ILLEGAL FORMAT IN G02.2/G03.2 (M series) | The end point, I, J, K, or R is missing from a command for involute interpolation. |
| 242 | ILLEGAL COMMAND IN G02.2/G03.2 (M series) | An invalid value has been specified for involute interpolation. <ul style="list-style-type: none"> The start or end point is within the basic circle. I, J, K, or R is set to 0. The number of rotations between the start of the involute curve and the start or end point exceeds 100. |
| 243 | OVER TOLERANCE OF END POINT (M series) | The end point is not on the involute curve which includes the start point and thus falls outside the range specified with parameter No. 5610. |
| 244 | P/S ALARM (T series) | In the skip function activated by the torque limit signal, the number of accumulated erroneous pulses exceed 32767 before the signal was input. Therefore, the pulses cannot be corrected with one distribution. Change the conditions, such as feed rates along axes and torque limit, and try again. |
| 245 | T-CODE NOT ALLOWED IN THIS BLOCK (T series) | One of the G codes, G50, G10, and G04, which cannot be specified in the same block as a T code, was specified with a T code. |
| 246 | ENCODE PROGRAM NUMBER ERROR | During read of an encrypted program, an attempt was made to store the program with a number exceeding the protection range. (See parameter Nos. 3222 and 223.) |
| 247 | ILLEGAL CODE USED FOR OUTPUT | When an encrypted program is output, EIA is set for the punch code. Specify ISO. |
| 250 | Z AXIS WRONG COMMAND (ATC) (M series) | Movement along the Z-axis is specified in a block specifying a tool change command (M06T_). (Only for ROBODRILL) |
| 251 | ATC ERROR (M series) | This alarm is issued in the following cases: <ul style="list-style-type: none"> An M06T_ command contains an unusable T code. An M06 command has been specified when the Z machine coordinate is positive. The parameter for the current tool number (No. 7810) is set to 0. An M06 command has been specified in canned cycle mode. A reference position return command (G27 to G44) and M06 command have been specified in the same block. An M06 command has been specified in tool compensation mode (G41 to G44). An M06 command has been specified without performing reference position return after power-on or the release of emergency stop. The machine lock signal or Z-axis ignore signal has been turned on during tool exchange. A pry alarm has been detected during tool exchange. Refer to diagnosis No. 530 to determine the cause. (Only for ROBODRILL) |

| Number | Message | Contents |
|--------|------------------------------------|--|
| 252 | ATC SPINDLE ALARM (M series) | An excessive error arose during spindle positioning for ATC. For details, refer to diagnosis No. 531. (Only for ROBODRILL) |
| 253 | G05 IS NOT AVAILABLE (M series) | Alarm details Binary input operation using high-speed remote buffer (G05) or high-speed cycle machining (G05) has been specified in advance control mode (G08P1). Execute G08P0; to cancel advance control mode, before executing these G05 commands. |

(2) Background edit alarm

| Number | Message | Contents |
|--------|------------|---|
| ??? | BP/S alarm | BP/S alarm occurs in the same number as the P/S alarm that occurs in ordinary program edit. (070, 071, 072, 073, 074 085,086,087 etc.) |
| 140 | BP/S alarm | It was attempted to select or delete in the background a program being selected in the foreground. (Note) Use background editing correctly. |

NOTE

Alarm in background edit is displayed in the key input line of the background edit screen instead of the ordinary alarm screen and is resettable by any of the MDI key operation.

(3) Absolute pulse coder (APC) alarm

| Number | Message | Contents |
|--------|---------------------------------------|---|
| 300 | APC alarm: nth-axis origin return | Manual reference position return is required for the nth-axis (n=1 – 8). |
| 301 | APC alarm: nth-axis communication | nth-axis (n=1 – 8) APC communication error. Failure in data transmission Possible causes include a faulty APC, cable, or servo interface module. |
| 302 | APC alarm: nth-axis over time | nth-axis (n=1 – 8) APC overtime error. Failure in data transmission. Possible causes include a faulty APC, cable, or servo interface module. |
| 303 | APC alarm: nth-axis framing | nth-axis (n=1 – 8) APC framing error. Failure in data transmission. Possible causes include a faulty APC, cable, or servo interface module. |
| 304 | APC alarm: nth-axis parity | nth-axis (n=1 – 8) APC parity error. Failure in data transmission. Possible causes include a faulty APC, cable, or servo interface module. |
| 305 | APC alarm: nth-axis pulse error | nth-axis (n=1 – 8) APC pulse error alarm. APC alarm. APC or cable may be faulty. |
| 306 | APC alarm: nth-axis battery voltage 0 | nth-axis (n=1 – 8) APC battery voltage has decreased to a low level so that the data cannot be held. APC alarm. Battery or cable may be faulty. |
| 307 | APC alarm: nth-axis battery low 1 | nth-axis (n=1 – 8) axis APC battery voltage reaches a level where the battery must be renewed. APC alarm. Replace the battery. |
| 308 | APC alarm: nth-axis battery low 2 | nth-axis (n=1 – 8) APC battery voltage has reached a level where the battery must be renewed (including when power is OFF). APC alarm .Replace battery. |
| 309 | APC ALARM: n AXIS ZRN IMPOSSIBL | Return to the origin has been attempted without first rotating the motor one or more times. Before returning to the origin, rotate the motor one or more times then turn off the power. |

(4) Inductosyn alarms

| Number | Message | Description |
|--------|------------------------|--|
| 330 | INDUCTOSYN:DATA ALARM | The absolute-position data (offset data) from Inductosyn cannot be detected. |
| 331 | INDUCTOSYN:ILLEGAL PRM | Parameter No. 1874, 1875, or 1876 is set to 0. |

(5) Serial pulse coder (SPC) alarms

| No. | Message | Description |
|-----|------------------------------------|--|
| 360 | n AXIS : ABNORMAL CHECKSUM (INT) | A checksum error occurred in the built-in pulse coder. |
| 361 | n AXIS : ABNORMAL PHASE DATA (INT) | A phase data error occurred in the built-in pulse coder. |
| 362 | n AXIS : ABNORMAL REV.DATA (INT) | A rotation speed count error occurred in the built-in pulse coder. |
| 363 | n AXIS : ABNORMAL CLOCK (INT) | A clock error occurred in the built-in pulse coder. |
| 364 | n AXIS : SOFT PHASE ALARM (INT) | The digital servo software detected invalid data in the built-in pulse coder. |
| 365 | n AXIS : BROKEN LED (INT) | An LED error occurred in the built-in pulse coder. |
| 366 | n AXIS : PULSE MISS (INT) | A pulse error occurred in the built-in pulse coder. |
| 367 | n AXIS : COUNT MISS (INT) | A count error occurred in the built-in pulse coder. |
| 368 | n AXIS : SERIAL DATA ERROR (INT) | Communication data from the built-in pulse coder cannot be received. |
| 369 | n AXIS : DATA TRANS. ERROR (INT) | A CRC or stop bit error occurred in the communication data being received from the built-in pulse coder. |
| 380 | n AXIS : BROKEN LED (EXT) | The LED of separate detector is erroneous. |
| 381 | n AXIS : ABNORMAL PHASE (EXT LIN) | A phase data error occurred in the separate linear scale. |
| 382 | n AXIS : COUNT MISS (EXT) | A pulse error occurred in the separate detector. |
| 383 | n AXIS : PULSE MISS (EXT) | A count error occurred in the separate detector. |
| 384 | n AXIS : SOFT PHASE ALARM (EXT) | The digital servo software detected invalid data in the separate detector. |
| 385 | n AXIS : SERIAL DATA ERROR (EXT) | Communication data from the separate detector cannot be received. |
| 386 | n AXIS : DATA TRANS. ERROR (EXT) | A CRC or stop bit error occurred in the communication data being received from the separate detector. |
| 387 | n AXIS : ABNORMAL ENCODER (EXT) | An error occurs in the separate detector. For details, contact the manufacturer of the scale. |

● **The details of serial pulse coder alarm**

The details of serial pulse coder alarm are displayed in the diagnosis display (No. 202 and No.203) as shown below.

| | #7 | #6 | #5 | #4 | #3 | #2 | #1 | #0 |
|-----|----|-----|-----|-----|-----|-----|-----|-----|
| 202 | | CSA | BLA | PHA | PCA | BZA | CKA | SPH |

#6 (CSA) : The serial pulse coder is defective. Replace it.

#5 (BLA) : The battery voltage is low. Replace the batteries.

#4 (PHA) : The serial pulse coder or feedback cable is defective. Replace the serial pulse coder or cable.

#3 (PCA) : The serial pulse coder is defective. Replace it.

#2 (BZA) : The pulse coder was supplied with power for the first time.
Make sure that the batteries are connected.

Turn the power off, then turn it on again and perform a reference position return.

#1 (CKA) : The serial pulse coder is defective. Replace it.

#0 (SPH) : The serial pulse coder or feedback cable is defective. Replace the serial pulse coder or cable.

| | #7 | #6 | #5 | #4 | #3 | #2 | #1 | #0 |
|-----|-----|-----|-----|-----|----|----|----|----|
| 203 | DTE | CRC | STB | PRM | | | | |

#7 (DTE) : The serial pulse coder encountered a communication error.
The pulse coder, feedback cable, or feedback receiver circuit is defective.
Replace the pulse coder, feedback cable, or NC-axis board

#6 (CRC) : The serial pulse coder encountered a communication error.
The pulse coder, feedback cable, or feedback receiver circuit is defective.
Replace the pulse coder, feedback cable, or NC-axis board.

#5 (STB) : The serial pulse coder encountered a communication error.
The pulse coder, feedback cable, or feedback receiver circuit is defective.
Replace the pulse coder, feedback cable, or NC-axis board.

#4 (PRM) : An invalid parameter was found. Alarm No. 417 (invalid servo parameter) is also issued.

(6) Servo alarms(1/2)

| Number | Message | Contents |
|--------|--|---|
| 401 | SERVO ALARM: n-TH AXIS VRDY OFF | The n-th axis (axis 1-4) servo amplifier READY signal (DRDY) went off. Refer to procedure of trouble shooting. |
| 402 | SERVO ALARM: SV CARD NOT EXIST | The axis control card is not provided. |
| 403 | SERVO ALARM: CARD/SOFT MISMATCH | The combination of the axis control card and servo software is illegal. The possible causes are as follows: <ul style="list-style-type: none"> · A correct axis control card is not provided. · Correct servo software is not installed on flash memory. |
| 404 | SERVO ALARM: n-TH AXIS VRDY ON | Even though the n-th axis (axis 1-4) READY signal (MCON) went off, the servo amplifier READY signal (DRDY) is still on. Or, when the power was turned on, DRDY went on even though MCON was off. Check that the servo interface module and servo amp are connected. |
| 405 | SERVO ALARM: (ZERO POINT RETURN FAULT) | Position control system fault. Due to an NC or servo system fault in the reference position return, there is the possibility that reference position return could not be executed correctly. Try again from the manual reference position return. |

| Number | Message | Contents |
|--------|--|--|
| 407 | SERVO ALARM: EXCESS ERROR | The following error occurred during simple synchronous control: The difference in machine coordinates between the synchronized axes exceeds the value set in parameter No. 8314. |
| 409 | SERVO ALARM: n AXIS TORQUE ALM | Abnormal servo motor load has been detected. Alternatively, abnormal spindle motor load has been detected in Cs mode. |
| 410 | SERVO ALARM: n-TH AXIS – EXCESS ERROR | One of the following errors occurred: 1) The positional deviation value when the n-th axis stops exceeds the value set in parameter No. 1829. 2) In simple synchronous control, the compensation amount for synchronization exceeds the value set in parameter No. 8325. This alarm is issued only for the slave axis. |
| 411 | SERVO ALARM: n-TH AXIS – EXCESS ERROR | The position deviation value when the n-th axis (axis 1–4) moves is larger than the set value. Refer to procedure of trouble shooting. |
| 413 | SERVO ALARM: n-th AXIS – LSI OVERFLOW | The contents of the error register for the n-th axis (axis 1–4) exceeded $\pm 2^{31}$ power. This error usually occurs as the result of an improperly set parameters. |
| 415 | SERVO ALARM: n-TH AXIS – EXCESS SHIFT | A speed higher than 524288000 units/s was attempted to be set in the n-th axis (axis 1–4). This error occurs as the result of improperly set CMR. |
| 417 | SERVO ALARM: n-TH AXIS – PARAMETER INCORRECT | This alarm occurs when the n-th axis (axis 1–4) is in one of the conditions listed below. (Digital servo system alarm) 1) The value set in Parameter No. 2020 (motor form) is out of the specified limit. 2) A proper value (111 or –111) is not set in parameter No.2022 (motor revolution direction). 3) Illegal data (a value below 0, etc.) was set in parameter No. 2023 (number of speed feedback pulses per motor revolution). 4) Illegal data (a value below 0, etc.) was set in parameter No. 2024 (number of position feedback pulses per motor revolution). 5) Parameters No. 2084 and No. 2085 (flexible field gear rate) have not been set. 6) A value outside the limit of {1 to the number of control axes} or a non-continuous value (Parameter 1023 (servo axis number) contains a value out of the range from 1 to the number of axes, or an isolated value (for example, 4 not preceded by 3).was set in parameter No. 1023 (servo axisnumber). 7) A torque control parameter is set incorrectly in PMC axis control. (The torque constant parameter is set to 0.) |
| 420 | SERVO ALARM: n AXIS SYNC TORQUE (M series) | During simple synchronous control, the difference between the torque commands for the master and slave axes exceeded the value set in parameter No. 2031. |
| 421 | SERVO ALARM: n AXIS EXCESS ER (D) | The difference between the errors in the semi-closed loop and closed loop has become excessive during dual position feedback. Check the values of the dual position conversion coefficients in parameters No. 2078 and 2079. |
| 422 | SERVO ALARM: n AXIS | In torque control of PMC axis control, a specified allowable speed has been exceeded. |
| 423 | SERVO ALARM: n AXIS | In torque control of PMC axis control, the parameter-set allowable cumulative travel distance has been exceeded. |
| 430 | n AXIS : SV. MOTOR OVERHEAT | A servo motor overheat occurred. |

| Number | Message | Contents |
|--------|------------------------------------|--|
| 431 | n AXIS : CNV. OVERLOAD | 1) PSM: Overheat occurred. 2) β series SVU: Overheat occurred. |
| 432 | n AXIS : CNV. LOW VOLT CONTROL | 1) PSM: Control power voltage has dropped. 2) PSMR: The control power supply voltage has dropped. 3) β series SVU: The control power supply voltage has dropped. |
| 433 | n AXIS : CNV. LOW VOLT DC LINK | 1) PSM: The DC link voltage has dropped. 2) PSMR: The DC link voltage has dropped. 3) α series SVU: The DC link voltage has dropped. 4) β series SVU: The DC link voltage has dropped. |
| 434 | n AXIS : INV. LOW VOLT CONTROL | SVM: The control power supply voltage has dropped. |
| 435 | n AXIS : INV. LOW VOLT DC LINK | SVM: The DC link voltage has dropped. |
| 436 | n AXIS : SOFTTHERMAL (OVC) | The digital servo software detected the soft thermal state (OVC). |
| 437 | n AXIS : CNV. OVERCURRENT POWER | PSM: Overcurrent flowed into the input circuit. |
| 438 | n AXIS : INV. ABNORMAL CURRENT | 1) SVM: The motor current is too high. 2) α series SVU: The motor current is too high. 3) β series SVU: The motor current is too high. |
| 439 | n AXIS : CNV. OVERVOLT POWER | 1) PSM: The DC link voltage is too high. 2) PSMR: The DC link voltage is too high. 3) α series SVU: The C link voltage is too high. 4) β series SVU: The link voltage is too high. |
| 440 | n AXIS : CNV. EX DECELERATION POW. | 1) PSMR: The regenerative discharge amount is too large. 2) α series SVU: The regenerative discharge amount is too large. Alternatively, the regenerative discharge circuit is abnormal. |
| 441 | n AXIS : ABNORMAL CURRENT OFFSET | The digital servo software detected an abnormality in the motor current detection circuit. |
| 442 | n AXIS : CNV. CHARGE FAILURE | 1) PSM: The spare discharge circuit of the DC link is abnormal. 2) PSMR: The spare discharge circuit of the DC link is abnormal. |
| 443 | n AXIS : CNV. COOLING FAN FAILURE | 1) PSM: The internal stirring fan failed. 2) PSMR: The internal stirring fan failed. 3) β series SVU: The internal stirring fan failed. |
| 444 | n AXIS : INV. COOLING FAN FAILURE | SVM: The internal stirring fan failed. |
| 445 | n AXIS : SOFT DISCONNECT ALARM | The digital servo software detected a broken wire in the pulse coder. |
| 446 | n AXIS : HARD DISCONNECT ALARM | A broken wire in the built-in pulse coder was detected by hardware. |
| 447 | n AXIS : HARD DISCONNECT (EXT) | A broken wire in the separate detector was detected by hardware. |
| 448 | n AXIS : UNMATCHED FEEDBACK ALARM | The sign of feedback data from the built-in pulse coder differs from that of feedback data from the separate detector. |
| 449 | n AXIS : INV. IPM ALARM | 1) SVM: IPM (intelligent power module) detected an alarm. 2) α series SVU: IPM (intelligent power module) detected an alarm. |
| 453 | n AXIS : SPC SOFT DISCONNECT ALARM | Software disconnection alarm of the α pulse coder. Turn off the power to the CNC, then remove and insert the pulse coder cable. If this alarm is issued again, replace the pulse coder. |

| Number | Message | Contents |
|--------|----------------------------------|---|
| 456 | ILLEGAL CURRENT LOOP | The current control cycle settings (parameter No. 2004, bit 0 of parameter No. 2003, and bit 0 of parameter No. 2013) are incorrect. Possible problems are as follows. <ul style="list-style-type: none"> – For the two axes whose servo axis numbers (settings of parameter No. 1023) are an odd number followed by an even number (a pair of axes 1 and 2 or axes 5 and 6, for example), a different current control cycle is set for each of the axes. – The requirements for slaves needed for the set current control cycle, including the number, type, and connection method of them, are not satisfied. |
| 457 | ILLEGAL HI HRV (250US) | Use of high-speed HRV is specified although the current control cycle is 250 μ s. |
| 458 | CURRENT LOOP ERROR | The current control cycle setting does not match the actual current control cycle. |
| 459 | HI HRV SETTING ERROR | Of two axes having adjacent servo axis numbers (parameter No. 1023), odd number and even number, high-speed HRV control can be performed for one axis and not for the other. |
| 460 | n AXIS : FSSB DISCONNECT | FSSB communication was disconnected suddenly. The possible causes are as follows: <ol style="list-style-type: none"> 1) The FSSB communication cable was disconnected or broken. 2) The power to the amplifier was turned off suddenly. 3) A low-voltage alarm was issued by the amplifier. |
| 461 | n AXIS : ILLEGAL AMP INTERFACE | The axes of the 2-axis amplifier were assigned to the fast type interface. |
| 462 | n AXIS : SEND CNC DATA FAILED | Because of an FSSB communication error, a slave could not receive correct data. |
| 463 | n AXIS : SEND SLAVE DATA FAILED | Because of an FSSB communication error, the servo system could not receive correct data. |
| 464 | n AXIS : WRITE ID DATA FAILED | An attempt was made to write maintenance information on the amplifier maintenance screen, but it failed. |
| 465 | n AXIS : READ ID DATA FAILED | At power-up, amplifier initial ID information could not be read. |
| 466 | n AXIS : MOTOR/AMP COMBINATION | The maximum current rating for the amplifier does not match that for the motor. |
| 467 | n AXIS : ILLEGAL SETTING OF AXIS | The servo function for the following has not been enabled when an axis occupying a single DSP (corresponding to two ordinary axes) is specified on the axis setting screen. <ol style="list-style-type: none"> 1. High-speed current loop (bit 0 of parameter No. 2004 = 1) 2. High-speed interface axis (bit 4 of parameter No. 2005 = 1) |
| 468 | HI HRV SETTING ERROR(AMP) | Use of high-speed HRV is specified for a controlled axis of an amplifier which does not support high-speed HRV. |

● **Details of servo alarm**

The details of servo alarm are displayed in the diagnosis display (No. 200, No.201, and No. 204) as shown below.

| | | | | | | | | |
|-----|-----|----|-----|-----|-----|-----|-----|-----|
| | #7 | #6 | #5 | #4 | #3 | #2 | #1 | #0 |
| 200 | OVL | LV | OVC | HCA | HVA | DCA | FBA | OFA |

#7 (OVL) : An overload alarm is being generated.

(The details are indicated in diagnostic data No.201).

#6 (LV) : A low voltage alarm is being generated in servo amp.
Check LED.

#5 (OVC) : A overcurrent alarm is being generated inside of digital servo.

#4 (HCA) : An abnormal current alarm is being generated in servo amp.
Check LED.

#3 (HVA) : An overvoltage alarm is being generated in servo amp.
Check LED.

#2 (DCA) : A regenerative discharge circuit alarm is being generated in servo amp.
Check LED.

#1 (FBA) : A disconnection alarm is being generated.
(The details are indicated in diagnostic data No. 201)

#0 (OFA) : An overflow alarm is being generated inside of digital servo.

| | | | | | | | | |
|-----|-----|----|----|-----|----|----|----|----|
| | #7 | #6 | #5 | #4 | #3 | #2 | #1 | #0 |
| 201 | ALD | | | EXP | | | | |

When OVL equal 1 in diagnostic data No.200 (servo alarm No. 400 is being generated):

#7 (ALD) 1 : Motor overheating

0 : Amplifier overheating

When FBAL equal 1 in diagnostic data No.200 (servo alarm No. 416 is being generated):

| ALD | EXP | Alarm details |
|-----|-----|---|
| 1 | 0 | Built-in pulse coder disconnection (hardware) |
| 1 | 1 | Separately installed pulse coder disconnection (hardware) |
| 0 | 0 | Pulse coder is not connected due to software. |

| | | | | | | | | |
|-----|----|-----|-----|-----|-----|----|----|----|
| | #7 | #6 | #5 | #4 | #3 | #2 | #1 | #0 |
| 204 | | OFS | MCC | LDA | PMS | | | |

#6 (OFS) : A current conversion error has occurred in the digital servo.

#5 (MCC) : A magnetic contactor contact in the servo amplifier has welded.

#4 (LDA) : The LED indicates that serial pulse coder C is defective

#3 (PMS) : A feedback pulse error has occurred because the feedback cable is defective.

(7) Over travel alarms

| Number | Message | Contents |
|--------|---|---|
| 500 | OVER TRAVEL : +n | Exceeded the n-th axis + side stored stroke check I. (Parameter No.1320 or 1326 NOTE) |
| 501 | OVER TRAVEL : -n | Exceeded the n-th axis - side stored stroke check I. (Parameter No.1321 or 1327 NOTE) |
| 502 | OVER TRAVEL : +n | Exceeded the n-th axis + side stored stroke check II. (Parameter No.1322) |
| 503 | OVER TRAVEL : -n | Exceeded the n-th axis - side stored stroke check II. (Parameter No.1323) |
| 504 | OVER TRAVEL : +n | Exceeded the n-th axis + side stored stroke check III. (Parameter No.1324) |
| 505 | OVER TRAVEL : -n | Exceeded the n-th axis - side stored stroke check III. (Parameter No.1325) |
| 506 | OVER TRAVEL : +n | Exceeded the n-th axis + side hardware OT. |
| 507 | OVER TRAVEL : -n | Exceeded the n-th axis - side hardware OT. |
| 508 | INTERFERENCE: +n (T series (two-path control)) | A tool moving in the positive direction along the n axis has fouled another tool post. |
| 509 | INTERFERENCE: -n (T series (two-path control)) | A tool moving in the negative direction along the n axis has fouled another tool post. |
| 510 | OVER TRAVEL: +n | Alarm for stroke check prior to movement. The end point specified in a block falls within the forbidden area defined with the stroke check in the positive direction along the N axis. Correct the program. |
| 511 | OVER TRAVEL: -n | Alarm for stroke check prior to movement. The end point specified in a block falls within the forbidden area defined with the stroke check in the negative direction along the N axis. Correct the program. |
| 514 | INTERFERENCE : +n | The rotation area interference check function found interference on the plus side of the n axis. |
| 515 | INTERFERENCE : -n | The rotation area interference check function found interference on the minus side of the n axis. |

NOTE

Parameters 1326 and 1327 are effective when EXLM(stroke check switch signal) is on.

(8) Servo alarms (2/2)

| Number | Message | Contents |
|--------|-----------------------------------|---|
| 600 | n AXIS: INV. DC LINK OVER CURRENT | DC link current is too large. |
| 601 | n AXIS: INV. RADIATOR FAN FAILURE | The external dissipator stirring fan failed. |
| 602 | n AXIS: INV. OVERHEAT | The servo amplifier was overheated. |
| 603 | n AXIS: INV. IPM ALARM(OH) | The IPM (intelligent power module) detected an overheat alarm. |
| 604 | n AXIS: AMP. COMMUNICATION ERROR | Communication between the SVM and the PSM failed. |
| 605 | n AXIS: CNV. EX. DISCHARGE POW. | PSMR: Regenerative power is too large. |
| 606 | n AXIS: CNV. RADIATOR FAN FAILURE | PSM: The external dissipator stirring fan failed. PSMR: The external dissipator stirring fan failed. |
| 607 | n AXIS: CNV. SINGLE PHASE FAILURE | PSM: Input voltage is in the open-phase condition. PSMR: Input voltage is in the open-phase condition. |

| Alarm No. with the servo amplifier in the warning state | Alarm No. with the servo amplifier in the alarm state | Alarm message |
|---|---|---|
| 608 | 444 | n axis : The inverter's internal cooling fan stopped. |
| 609 | 601 | n axis : The inverter radiator cooling fan stopped. |
| 610 | 443 | n axis : The converter cooling fan stopped. |
| 611 | 606 | n axis : The converter radiator cooling fan stopped. |
| 612 | 431 | n axis : The converter main circuit was overloaded. |
| 613 | 607 | n axis : The converter main power supply encountered an open-phase condition. |

(9) Overheat alarms

| Number | Message | Contents |
|--------|------------------------|--|
| 700 | OVERHEAT: CONTROL UNIT | Control unit overheat Check that the fan motor operates normally, and clean the air filter. |
| 701 | OVERHEAT: FAN MOTOR | The fan motor on the top of the cabinet for the control unit is overheated. Check the operation of the fan motor and replace the motor if necessary. |
| 704 | OVERHEAT: SPINDLE | Spindle overheat in the spindle fluctuation detection (1) If the cutting load is heavy, relieve the cutting condition. (2) Check whether the cutting tool is share. (3) Another possible cause is a faulty spindle amp. |

(10) Rigid tapping alarms

| Number | Message | Contents |
|--------|-------------------------------|--|
| 740 | RIGID TAP ALARM: EXCESS ERROR | The positional deviation of the stopped spindle has exceeded the set value during rigid tapping. |
| 741 | RIGID TAP ALARM: EXCESS ERROR | The positional deviation of the moving spindle has exceeded the set value during rigid tapping. |
| 742 | RIGID TAP ALARM: LSI OVERFLOW | An LSI overflow has occurred for the spindle during rigid tapping. |

(11)Serial spindle alarms

| Number | Message | Contents |
|--------|----------------------------------|---|
| 749 | S-SPINDLE LSI ERROR | <p>It is serial communication error while system is executing after power supply on. Following reasons can be considered.</p> <ol style="list-style-type: none"> 1) Optical cable connection is fault or cable is not connected or cable is cut. 2) MAIN CPU board or option 2 board is fault. 3) Spindle amp. printed board is fault. 4) The spindle amplifier is under an abnormal condition. (The SPM indication is A, A1, A2, or the like, depending on the type of the abnormality.) <p>If this alarm occurs when CNC power supply is turned on or when this alarm can not be cleared even if CNC is reset, turn off the power supply also turn off the power supply in spindle side.</p> <p>If the spindle amplifier is under an abnormal condition, check the SPM indication (A, A1, A2, or the like). Then, refer to the FANUC SERVOMOTOR <i>ai</i> series MAINTENANCE MANUAL (B-65285EN) or FANUC SERVO MOTOR α series MAINTENANCE MANUAL (B-65165E) to solve the problem.</p> |
| 750 | SPINDLE SERIAL LINK START FAULT | <p>This alarm is generated when the spindle control unit is not ready for starting correctly when the power is turned on in the system with the serial spindle.</p> <p>The four reasons can be considered as follows:</p> <ol style="list-style-type: none"> 1) An improperly connected optic cable, or the spindle control unit's power is OFF. 2) When the NC power was turned on under alarm conditions other than SU-01 or AL-24 which are shown on the LED display of the spindle control unit. In this case, turn the spindle amplifier power off once and perform startup again. 3) Other reasons (improper combination of hardware) This alarm does not occur after the system including the spindle control unit is activated. 4) The second spindle (when SP2, bit 4 of parameter No. 3701, is 1) is in one of the above conditions 1) to 3). <p>See diagnostic display No. 409 for details.</p> |
| 752 | FIRST SPINDLE MODE CHANGE FAULT | <p>This alarm is generated if the system does not properly terminate a mode change. The modes include the Cs contouring, spindle positioning, rigid tapping, and spindle control modes. The alarm is activated if the spindle control unit does not respond correctly to the mode change command issued by the NC.</p> |
| 754 | SPINDLE-1 ABNORMAL TORQUE ALM | Abnormal first spindle motor load has been detected. |
| 762 | SECOND SPINDLE MODE CHANGE FAULT | Refer to alarm No. 752.(For 2nd axis) |
| 764 | SPINDLE-2 ABNORMAL TORQUE ALM | Same as alarm No. 754 (for the second spindle) |
| 772 | SPINDLE-3 MODE CHANGE ERROR | Same as alarm No. 752 (for the third spindle) |
| 774 | SPINDLE-3 ABNORMAL TORQUE ALM | Same as alarm No. 754 (for the third spindle) |
| 782 | SPINDLE-4 MODE CHANGE ERROR | Same as alarm number 752 (for the fourth spindle) |
| 784 | SPINDLE-4 ABNORMAL TORQUE ALM | Same as alarm number 754 (for the fourth spindle) |

- The details of spindle alarm No.750

- 1st and 2nd spindles

| | #7 | #6 | #5 | #4 | #3 | #2 | #1 | #0 |
|-----|----|----|----|----|-----|-----|-----|-----|
| 409 | | | | | SPE | S2E | S1E | SHE |

#3 (SPE) 0 : In the spindle serial control, the serial spindle parameters fulfill the spindle unit startup conditions.

1 : In the spindle serial control, the serial spindle parameters do not fulfill the spindle unit startup conditions.

#2 (S2E) 0 : The second spindle is normal during the spindle serial control startup.

1 : The second spindle was detected to have a fault during the spindle serial control startup.

#1 (S1E) 0 : The first spindle is normal during the spindle serial control startup.

1 : The first spindle was detected to have a fault during the spindle axis serial control startup.

#0 (SHE) 0 : The serial communications module in the CNC is normal.

1 : The serial communications module in the CNC was detected to have a fault.

- 3rd and 4th spindles

The details of spindle alarm No. 750 are displayed in the diagnosis display (No. 409) as shown below.

| | #7 | #6 | #5 | #4 | #3 | #2 | #1 | #0 |
|-----|----|----|----|----|-----|-----|-----|-----|
| 409 | | | | | SPE | S4E | S3E | SHE |

#3 (SPE) 0 : In the spindle serial control, the serial spindle parameters fulfill the spindle unit startup conditions.

1 : In the spindle serial control, the serial spindle parameters do not fulfill the spindle unit startup conditions.

#2 (S2E) 0 : The fourth spindle is normal during the spindle serial control startup.

1 : The fourth spindle was detected to have a fault during the spindle serial control startup.

#1 (S1E) 0 : The third spindle is normal during the spindle serial control startup.

1 : The third spindle was detected to have a fault during the spindle axis serial control startup.

#0 (SHE) 0 : The serial communications module in the CNC is normal.

1 : The serial communications module in the CNC was detected to have a fault.

(12) System alarms

(These alarms cannot be reset with reset key.)

| Number | Message | Description |
|--------|--|---|
| 900 | ROM PARITY | A parity error occurred in the CNC, macro, or servo ROM. Correct the contents of the flash ROM having the displayed number. |
| 910 | SRAM PARITY : (BYTE 0) | A RAM parity error occurred in the part program storage RAM. Clear the RAM, or replace the SRAM module or motherboard. Subsequently, re-set the parameters and all other data. |
| 911 | SRAM PARITY : (BYTE 1) | |
| 912 | DRAM PARITY : (BYTE 0) | |
| 913 | DRAM PARITY : (BYTE 1) | |
| 914 | DRAM PARITY : (BYTE 2) | |
| 915 | DRAM PARITY : (BYTE 3) | |
| 916 | DRAM PARITY : (BYTE 4) | |
| 917 | DRAM PARITY : (BYTE 5) | |
| 918 | DRAM PARITY : (BYTE 6) | |
| 919 | DRAM PARITY : (BYTE 7) | |
| 920 | SERVO ALARM (1-4 AXIS) | Servo alarm (first to fourth axis). A watchdog alarm condition occurred, or a RAM parity error occurred in the axis control card (axis/display card). Replace the axis control card (axis/display card). |
| 921 | SERVO ALARM (5-8 AXIS) | Servo alarm (fifth to eighth axis). A watchdog alarm condition occurred, or a RAM parity error occurred in the axis control card (axis/display card). Replace the axis control card (axis/display card). |
| 926 | FSSB ALARM | FSSB alarm. Replace the axis control card (axis/display card). |
| 930 | CPU INTERRUPT | CPU error (abnormal interrupt). The motherboard or CPU card may be faulty. |
| 935 | SRAM ECC ERROR | An error occurred in RAM for part program storage. Action: Replace the main board (SRAM module), perform all-clear operation, and set all parameter and other data again. |
| 950 | PMC SYSTEM ALARM PCxxx YYYYYYYYYYYYYY | An error occurred in the PMC. For details of PCxxx, see the list of system alarm messages in Section A.2, "LIST OF ALARMS (PMC)" in this manual. |
| 951 | PMC WATCH DOG ALARM | An error occurred in the PMC. (Watchdog alarm) The main board may be faulty. |
| 970 | NMI OCCURRED IN PMCLSI | An error occurred in the PMC control LSI device on the main board. (I/O RAM parity) Replace the main board. |
| 971 | NMI OCCURRED IN SLC | An I/O Link disconnection was detected. Check the I/O Link. |
| 972 | NMI OCCURRED IN OTHER MODULE | An NMI occurred on a board other than the main board. The option board may be faulty. |
| 973 | NON MASK INTERRUPT | An NMI occurred as a result of an unknown cause. |
| 974 | F-BUS ERROR | A bus error occurred on the FANUC bus. The main board or option board may be faulty. |

| Number | Message | Description |
|--------|-------------|--|
| 975 | BUS ERROR | A bus error occurred on the main board. The main board may be faulty. |
| 976 | L-BUS ERROR | A bus error occurred on the local bus. The main board may be faulty. |

(13) Alarms of Series 0i-PC

| Number | Message | Contents |
|--------|----------------------------------|---|
| 4500 | REPOSITIONING INHIBITED | A repositioning command was specified in the circular interpolation (G02, G03) mode. |
| 4502 | ILLEGAL COMMAND IN BOLT HOLE | In a bolt hole circle (G26) command, the radius (I) was set to zero or a negative value, or the number of holes (K) was set to zero. Alternatively, I, J, or K was not specified. |
| 4503 | ILLEGAL COMMAND IN LINE AT ANGLE | In a line-at-angle (G76) command, the number of holes (K) was set to zero or a negative value. Alternatively, I, J, or K was not specified. |
| 4504 | ILLEGAL COMMAND IN ARC | In an arc (G77) command, the radius (I) or the number of holes (K) was set to zero or a negative value. Alternatively, I, J, K, or P was not specified. |
| 4505 | ILLEGAL COMMAND IN GRID | In a grid (G78, G79) command, the number of holes (P, K) was set to zero or a negative value. Alternatively, I, J, K, or P was not specified. |
| 4506 | ILLEGAL COMMAND IN SHARE PROOFS | In a shear proof (G86) command, the tool size (P) was set to zero, or the blanking length (I) was 1.5 times larger than the tool size (P) or less. Alternatively, I, J, or P was not specified. |
| 4507 | ILLEGAL COMMAND IN SQUARE | In a square (G87) command, the tool size (P,Q) was set to zero or a negative value, or the blanking length (I, J) was three times larger than the tool size (P, Q) or less. Alternatively, I, J, P, or Q was not specified. |
| 4508 | ILLEGAL COMMAND IN RADIUS | In a radius (G88) command, the traveling pitch (Q) or radius (I) was set to zero or a negative value, or the traveling pitch (Q) was greater than or equal to the arc length. Alternatively, I, J, K, P, or Q was not specified. |
| 4509 | ILLEGAL COMMAND IN CUT AT ANGLE | In a cut-at-angle (G89) command, the traveling pitch (Q) was set to zero, negative value, or another value larger than or equal to the length (I). Alternatively, I, J, P, or Q was not specified. |
| 4520 | T, M INHIBITED IN NIBBLING-MODE | T code, M code, G04, G70 or G75 was specified in the nibbling mode. |
| 4521 | EXCESS NIBBLING MOVEMENT (X, Y) | In the nibbling mode, the X-axis or Y-axis traveling distance was larger than or equal to the limit (No. 16188 to 16193). |
| 4522 | EXCESS NIBBLING MOVEMENT (C) | In the circular nibbling (G68) or usual nibbling mode, the C-axis traveling distance was larger than or equal to the limit (No. 16194). |
| 4523 | ILLEGAL COMMAND IN CIRCLE-NIBBL | In a circular nibbling (G68) command, the traveling pitch (Q) was set to zero, a negative value, or a value larger than or equal to the limit (No. 16186, 16187), or the radius (I) was set to zero or a negative value. Alternatively, I, J, K, P, or Q was not specified. |
| 4524 | ILLEGAL COMMAND IN LINE-NIBBL | In a linear nibbling (G69) command, the traveling pitch (Q) was set to zero, negative value, or a value larger than or equal to the limit (No. 16186, 16187). Alternatively, I, J, P, or Q was not specified. |
| 4530 | A/B MACRO NUMBER ERROR | The number for storing and calling by an A or B macro was set to a value beyond the range from 1 to 5. |

| Number | Message | Contents |
|--------|----------------------------------|---|
| 4531 | U/V MACRO FORMAT ERROR | An attempt was made to store a macro while storing another macro using a U or V macro. A V macro was specified although the processing to store a macro was not in progress. A U macro number and V macro number do not correspond with each other. |
| 4532 | IMPROPER U/V MACRO NUMBER | The number of an inhibited macro (number beyond the range from 01 to 99) was specified in a U or V macro command. |
| 4533 | U/V MACRO MEMORY OVERFLOW | An attempt was made to store too many macros with a U or V macro command. |
| 4534 | W MACRO NUMBER NOT FOUND | Macro number W specified in a U or V macro command is not stored. |
| 4535 | U/V MACRO NESTING ERROR | An attempt was made to call a macro which is defined three times or more using a U or V macro command. An attempt was made to store 15 or more macros in the storage area for macros of number 90 to 99. |
| 4536 | NO W, Q COMMAND IN MULTI-PIECE | W or Q was not specified in the command for taking multiple workpieces (G73, G74). |
| 4537 | ILLEGAL Q VALUE IN MULTI-PIECE | In the command for taking multiple workpieces (G73, G74), Q is set to a value beyond the range from 1 to 4. |
| 4538 | W NO. NOT FOUND IN MULTI-PIECE | Macro number W specified in the command for taking multiple workpieces (G73, G74) is not stored. |
| 4539 | MULTI-PIECE SETTING IS ZERO | The command for taking multiple workpieces (G73, G74) was specified although zero is specified for the function to take multiple workpieces (No. 16206 or signals MLP1 and MLP2 (PMC address G231, #0 and #1)). |
| 4540 | MULTI-PIECE COMMAND WITHIN MACRO | The command for taking multiple workpieces (G73, G74) was specified when a U or V macro was being stored. |
| 4542 | MULTI-PIECE COMMAND ERROR | Although G98P0 was specified, the G73 command was issued. Although G98K0 was specified, the G74 command was issued. |
| 4543 | MULTI-PIECE Q COMMAND ERROR | Although G98P0 was specified, the Q value for the G74 command was not 1 or 3. Although G98K0 was specified, the Q value for the G73 command was not 1 or 2. |
| 4544 | MULTI-PIECE RESTART ERROR | In the command for resuming taking multiple workpieces, the resume position (P) is set to a value beyond the range from 1 to total number of workpieces to be machined. |
| 4600 | T, C COMMAND IN INTERPOLATION | In the linear interpolation (G01) mode or circular interpolation (G02, G03) mode, a T command or C-axis command was specified. |
| 4601 | INHIBITED T, M COMMAND | In the block of G52, G72, G73, or G74, a T or M command was specified. |
| 4602 | ILLEGAL T-CODE | The specified T command is not cataloged on the tool register screen. |
| 4606 | A T COMMAND WAS ISSUED | A T command was issued during normal-line control. |
| 4650 | IMPROPER G-CODE IN OFFSET MODE | In the cutter compensation mode, an inhibited G code (pattern command, G73, G74, G75, etc.) was specified. |
| 4700 | PROGRAM ERROR (OT +) | The value specified in the X-axis move command exceeded the positive value of stored stroke limit 1. (Advance check) |
| 4701 | PROGRAM ERROR (OT -) | The value specified in the X-axis move command exceeded the negative value of stored stroke limit 1. (Advance check) |
| 4702 | PROGRAM ERROR (OT +) | The value specified in the Y-axis move command exceeded the positive value of stored stroke limit 1. (Advance check) |

| Number | Message | Contents |
|--------|--------------------------------|---|
| 4703 | PROGRAM ERROR (OT -) | The value specified in the Y-axis move command exceeded the negative value of stored stroke limit 1. (Advance check) |
| 4800 | ZONE : PUNCHING INHIBITED 1 | When a safety zone check was executed, a punch command was specified in area 1 where punching is inhibited. |
| 4801 | ZONE : PUNCHING INHIBITED 2 | When a safety zone check was executed, a punch command was specified in area 2 where punching is inhibited. |
| 4802 | ZONE : PUNCHING INHIBITED 3 | When a safety zone check was executed, a punch command was specified in area 3 where punching is inhibited. |
| 4803 | ZONE : PUNCHING INHIBITED 4 | When a safety zone check was executed, a punch command was specified in area 4 where punching is inhibited. |
| 4810 | ZONE : ENTERING INHIBITED 1 +X | When a safety zone check was executed, the machine moving in the positive X direction entered area 1 into which entry is inhibited. |
| 4811 | ZONE : ENTERING INHIBITED 1 -X | When a safety zone check was executed, the machine moving in the negative X direction entered area 1 into which entry is inhibited. |
| 4812 | ZONE : ENTERING INHIBITED 2 +X | When a safety zone check was executed, the machine moving in the positive X direction entered area 2 into which entry is inhibited. |
| 4813 | ZONE : ENTERING INHIBITED 2 -X | When a safety zone check was executed, the machine moving in the negative X direction entered area 2 into which entry is inhibited. |
| 4814 | ZONE : ENTERING INHIBITED 3 +X | When a safety zone check was executed, the machine moving in the positive X direction entered area 3 into which entry is inhibited. |
| 4815 | ZONE : ENTERING INHIBITED 3 -X | When a safety zone check was executed, the machine moving in the negative X direction entered area 3 into which entry is inhibited. |
| 4816 | ZONE : ENTERING INHIBITED 4 +X | When a safety zone check was executed, the machine moving in the positive X direction entered area 4 into which entry is inhibited. |
| 4817 | ZONE : ENTERING INHIBITED 4 -X | When a safety zone check was executed, the machine moving in the negative X direction entered area 4 into which entry is inhibited. |
| 4830 | ZONE : ENTERING INHIBITED 1 +Y | When a safety zone check was executed, the machine moving in the positive Y direction entered area 1 into which entry is inhibited. |
| 4831 | ZONE : ENTERING INHIBITED 1 -Y | When a safety zone check was executed, the machine moving in the negative Y direction entered area 1 into which entry is inhibited. |
| 4832 | ZONE : ENTERING INHIBITED 2 +Y | When a safety zone check was executed, the machine moving in the positive Y direction entered area 2 into which entry is inhibited. |
| 4833 | ZONE : ENTERING INHIBITED 2 -Y | When a safety zone check was executed, the machine moving in the negative Y direction entered area 2 into which entry is inhibited. |
| 4834 | ZONE : ENTERING INHIBITED 3 +Y | When a safety zone check was executed, the machine moving in the positive Y direction entered area 3 into which entry is inhibited. |
| 4835 | ZONE : ENTERING INHIBITED 3 -Y | When a safety zone check was executed, the machine moving in the negative Y direction entered area 3 into which entry is inhibited. |
| 4836 | ZONE : ENTERING INHIBITED 4 +Y | When a safety zone check was executed, the machine moving in the positive Y direction entered area 4 into which entry is inhibited. |
| 4837 | ZONE : ENTERING INHIBITED 4 -Y | When a safety zone check was executed, the machine moving in the negative Y direction entered area 4 into which entry is inhibited. |
| 4870 | AUTO SETTING FEED ERROR | The feed rate of safety zone auto setting is other than the parameter value (No. 16538, No. 16539). |

| Number | Message | Contents |
|--------|----------------------------|--|
| 4871 | AUTO SETTING PIECES ERROR | In safety zone auto setting, the safety zone pieces are not correct. Or the position detector has gone wrong, please tell your machine tool builder. |
| 4872 | AUTO SETTING COMMAND ERROR | M code, S code or T code is specified with safety zone auto setting command (G32). G32 is specified in the nibbling mode, in the cutter compensation, in the rotation mode or the scaling mode. |

(14) Program errors/Alarms on program and operation (P/S alarm) (2/2)

| Number | Message | Contents |
|--------|---|---|
| 5010 | END OF RECORD | The end of record (%) was specified. I/O is incorrect. modify the program. |
| 5011 | PARAMETER ZERO(CUT MAX) (M series) | The maximum cutting feedrate (parameter No. 1422, No. 1430, No. 1431, No. 1432) is 0 in the HPCC mode. |
| 5014 | TRACE DATA NOT FOUND | Transfer cannot be performed because no trace data exists. |
| 5015 | NO ROTATION AXIS (M series) | The specified rotation axis does not exist for tool axis direction handle feed. |
| 5016 | ILLEGAL COMBINATION OF M CODE | M codes which belonged to the same group were specified in a block. Alternatively, an M code which must be specified without other M codes in the block was specified in a block with other M codes. |
| 5018 | POLYGON SPINDLE SPEED ERROR (T series) | Function category: Polygon turning Alarm details: In G51.2 mode, the speed of the spindle or polygon synchronous axis either exceeds the clamp value or is too small. The specified rotation speed ratio thus cannot be maintained. |
| 5020 | PARAMETER OF RESTART ERROR | An erroneous parameter was specified for restarting a program. A parameter for program restart is invalid. |
| 5043 | TOO MANY G68 NESTING (M series) | Three-dimensional coordinate conversion G68 has been specified three or more times. |
| | TOO MANY G68 NESTING (T series) | Three-dimensional coordinate conversion G68.1 has been specified three or more times. |
| 5044 | G68 FORMAT ERROR (M series) | A G68 command block contains a format error. This alarm is issued in the following cases: 1. I, J, or K is missing from a G68 command block (missing coordinate rotation option). 2. I, J, and K are 0 in a G68 command block. 3. R is missing from a G68 command block. |
| | G68.1 FORMAT ERROR (T series) | A G68.1 command block contains a format error. This alarm is issued in the following cases: 1. I, J, or K is missing from a G68.1 command block (missing coordinate rotation option). 2. I, J, and K are 0 in a G68.1 command block. 3. R is missing from a G68.1 command block. |

| Number | Message | Contents |
|--------|---|---|
| 5046 | ILLEGAL PARAMETER (ST.COMP) | The parameter settings for straightness compensation contain an error. Possible causes are as follows: <ol style="list-style-type: none"> 1. A parameter for a movement axis or compensation axis contains an axis number which is not used. 2. More than 128 pitch error compensation points exist between the negative and positive end points. 3. Compensation point numbers for straightness compensation are not assigned in the correct order. 4. No straightness compensation point exists between the pitch error compensation points at the negative and positive ends. 5. The compensation value for each compensation point is too large or too small. 6. The settings of parameters Nos. 13881 to 13886 are illegal (in the interpolation type straightness compensation). |
| 5050 | ILL-COMMAND IN CHOPPING MODE (M series) | A command for switching the major axis has been specified for circular threading. Alternatively, a command for setting the length of the major axis to 0 has been specified for circular threading. |
| 5051 | M-NET CODE ERROR | Abnormal character received (other than code used for transmission) |
| 5052 | M-NET ETX ERROR | Abnormal ETX code |
| 5053 | M-NET CONNECT ERROR | Connection time monitoring error (parameter No. 175) |
| 5054 | M-NET RECEIVE ERROR | Polling time monitoring error (parameter No. 176) |
| 5055 | M-NET PRT/FRT ERROR | Vertical parity or framing error |
| 5057 | M-NET BOARD SYSTEM DOWN | Transmission timeout error (parameter No. 177) ROM parity error CPU interrupt other than the above |
| 5058 | G35/G36 FORMAT ERROR (T series) | A command for switching the major axis has been specified for circular threading. Alternatively, a command for setting the length of the major axis to 0 has been specified for circular threading. |
| 5059 | RADIUS IS OUT OF RANGE | A radius exceeding nine digits has been specified for circular interpolation with the center of the arc specified with I, J, and K. |
| 5060 | ILLEGAL PARAMETER IN G02.3/G03.3 (M series) | There is a parameter setting error. Parameter No. 5641 (setting of the linear axis) is not set. The axis set in parameter No. 5641 is not a linear axis. Parameter No. 5642 (setting of a rotation axis) is not set. The axis set in parameter No. 5642 is not a rotation axis. The linear and rotation axes cannot be controlled by the CNC. (The value set in parameter No. 1010 is exceeded.) |
| 5061 | ILLEGAL FORMAT IN G02.3/G03.3 (M series) | The exponential interpolation command (G02.3/G03.3) has a format error. Address I, J, or K is not specified. The value of address I, J, or K is 0. |
| 5062 | ILLEGAL COMMAND IN G02.3/G03.3 | The value specified in an exponential interpolation command (G02.3/G03.3) is illegal. A value that does not allow exponential interpolation is specified. (For example, a negative value is specified in In.) |
| 5063 | IS NOT PRESET AFTER REF. (M series) | Function category: Workpiece thickness measurement Alarm details The position counter was not preset before the start of workpiece thickness measurement. This alarm is issued in the following cases: <ol style="list-style-type: none"> (1) An attempt has been made to start measurement without first establishing the origin. (2) An attempt has been made to start measurement without first pre-setting the position counter after manual return to the origin. |

| Number | Message | Contents |
|--------|---|--|
| 5064 | DIFFERENT AXIS UNIT (IS-B, IS-C) (M series) | Circular interpolation has been specified on a plane consisting of axes having different increment systems. |
| 5065 | DIFFERENT AXIS UNIT (PMC AXIS) (M series) | Axes having different increment systems have been specified in the same DI/DO group for PMC axis control. Modify the setting of parameter No. 8010. |
| 5067 | G05 PO COMMANDED IN G68/G51 MODE (HPCC) (M series) | HPCC mode cannot be canceled during G51 (scaling) or G68 (coordinate system rotation). Correct the program. |
| 5068 | G31 FORMAT ERROR (M series) | The continuous high-speed skip command (G31 P90) has one of the following errors: <ol style="list-style-type: none"> 1. The axis along which the tool is moved is not specified. 2. More than one axis is specified as the axis along which the tool is moved. Alternatively, the EGB skip command (G31.8) or continuous high-speed skip command (G31.9) has one of the following errors: <ol style="list-style-type: none"> 1. A move command is specified for the EGB axis (workpiece axis). 2. More than one axis is specified. 3. P is not specified. 4. The specified Q value exceeds the allowable range. Correct the program. |
| 5069 | WHL-C:ILLEGAL P-DATA (M series) | The P data in selection of the grinding-wheel wear compensation center is illegal. |
| 5073 | NO DECIMAL POINT | No decimal point has been specified for an address requiring a decimal point. |
| 5074 | ADDRESS DUPLICATION ERROR | The same address has been specified two or more times in a single block. Alternatively, two or more G codes in the same group have been specified in a single block. |
| 5082 | DATA SERVER ERROR | This alarm is detailed on the data server message screen. |
| 5085 | SMOOTH IPL ERROR 1 (M series) | A block for specifying smooth interpolation contains a syntax error. |
| 5096 | MISMATCH WAITING M-CODE (M series) | Different wait codes (M codes) were specified in HEAD1 and HEAD2. Correct the program. |
| 5110 | NOT STOP POSITION (G05.1 G1) (M series) | An illegal G code was specified in AI contour control mode. A command was specified for the index table indexing axis in AI control mode. |
| | NOT STOP POSITION (G05.1 G1) (21i-M) | An illegal G code was specified in AI look-ahead control mode. A command was specified for the index table indexing axis in AI look-ahead control mode. |
| 5111 | IMPROPER MODEL G-CODE (G05.1 G1) (M series) | An illegal G code is left modal when AI contour control mode was specified. |
| | IMPROPER MODEL G-CODE (G05.1 G1) (21i-M) | An illegal G code is left modal when AI look-ahead control mode was specified. |
| 5112 | G08 CAN NOT BE COMMANDED (G05.1 G1) (M series) | Look-ahead control (G08) was specified in AI contour control mode. |
| | G08 CAN NOT BE COMMANDED (G05.1 G1) (21i-M) | Look-ahead control (G08) was specified in AI look-ahead control mode. |

| Number | Message | Contents |
|--------|---|--|
| 5114 | NOT STOP POSITION (G05.1 Q1) (M series) | At the time of restart after manual intervention, the coordinates at which the manual intervention occurred have not been restored. |
| 5115 | SPL : ERROR (M series) | There is an error in the specification of the rank. |
| | | No knot is specified. |
| | | The knot specification has an error. |
| | | The number of axes exceeds the limits. |
| 5116 | SPL : ERROR (M series) | Other program errors |
| | | There is a program error in a block under look-ahead control. |
| | | Monotone increasing of knots is not observed. |
| 5117 | SPL : ERROR (M series) | In NURBS interpolation mode, a mode that cannot be used together is specified. |
| | | The first control point of NURBS is incorrect. |
| 5118 | SPL : ERROR (M series) | After manual intervention with manual absolute mode set to on, NURBS interpolation was restarted. |
| 5122 | ILLEGAL COMMAND IN SPIRAL (M series) | A spiral interpolation or conical interpolation command has an error. Specifically, this error is caused by one of the following: <ol style="list-style-type: none"> 1) L = 0 is specified. 2) Q = 0 is specified. 3) R/, R/, C is specified. 4) Zero is specified as height increment. 5) Three or more axes are specified as the height axes. 6) A height increment is specified when there are two height axes. 7) Conical interpolation is specified when the helical interpolation function is not selected. 8) Q < 0 is specified when radius difference > 0. 9) Q > 0 is specified when radius difference < 0. 10) A height increment is specified when no height axis is specified. |
| 5123 | OVER TOLERANCE OF END POINT (M series) | The difference between a specified end point and the calculated end point exceeds the allowable range (parameter 3471). |
| 5124 | CAN NOT COMMAND SPIRAL (M series) | A spiral interpolation or conical interpolation was specified in any of the following modes: <ol style="list-style-type: none"> 1) Scaling 2) Programmable mirror image 3) Polar coordinate interpolation In cutter compensation C mode, the center is set as the start point or end point. |
| 5134 | FSSB : OPEN READY TIME OUT | Initialization did not place FSSB in the open ready state. |
| 5135 | FSSB : ERROR MODE | FSSB has entered error mode. |
| 5136 | FSSB : NUMBER OF AMPS IS SMALL | In comparison with the number of controlled axes, the number of amplifiers recognized by FSSB is not enough. |
| 5137 | FSSB : CONFIGURATION ERROR | FSSB detected a configuration error. |
| 5138 | FSSB : AXIS SETTING NOT COMPLETE | In automatic setting mode, axis setting has not been made yet. Perform axis setting on the FSSB setting screen. |
| 5139 | FSSB : ERROR | Servo initialization did not terminate normally. The optical cable may be defective, or there may be an error in connection to the amplifier or another module. Check the optical cable and the connection status. |

| Number | Message | Contents |
|--------|--|---|
| 5155 | NOT RESTART PROGRAM BY G05 | During servo leaning control by G05, an attempt was made to perform restart operation after feed hold or interlock. This restart operation cannot be performed. (G05 leaning control terminates at the same time.) |
| 5156 | ILLEGAL AXIS OPERATION (AICC) (M series) | In AI contour control mode, the controlled axis selection signal (PMC axis control) changes. In AI contour control mode, the simple synchronous axis selection signal changes. |
| | ILLEGAL AXIS OPERATION (AICC) (21i-M) | In AI look-ahead control mode, the controlled axis selection signal (PMC axis control) changes. In AI look-ahead control mode, the simple synchronous axis selection signal changes. |
| 5157 | PARAMETER ZERO (AICC) (M series) | Zero is set in the parameter for the maximum cutting feedrate (parameter No. 1422 or 1432). Zero is set in the parameter for the acceleration/deceleration before interpolation (parameter No. 1770 or 1771). Set the parameter correctly. |
| 5195 | DIRECTION CAN NOT BE JUDGED (T series) | When the touch sensor with a single contact signal input is used in the direct input B function for tool offset measurement values, the stored pulse direction is not constant. One of the following conditions exists: <ul style="list-style-type: none"> · The stop state exists in offset write mode. · Servo off state · The direction varies. · Movement takes place simultaneously along two axes. |
| 5196 | ILLEGAL OPERATION (HPCC) (M series) | Detach operation was performed in HPCC mode. (If detach operation is performed in HPCC mode, this alarm is issued after the currently executed block terminates.) |
| 5197 | FSSB : OPEN TIME OUT | The CNC permitted FSSB to open, but FSSB was not opened. |
| 5198 | FSSB : ID DATA NOT READ | Temporary assignment failed, so amplifier initial ID information could not be read. |
| 5199 | FINE TORQUE SENSING PARAMETER | A parameter related to the fine torque sensing function is illegal. <ul style="list-style-type: none"> · The storage interval is invalid. · An invalid axis number is set as the target axis. Correct the parameter. |
| 5218 | ILLEGAL PARAMETER (INCL. COMP) | There is an inclination compensation parameter setting error. Cause: <ol style="list-style-type: none"> 1. The number of pitch error compensation points between the negative (-) end and positive (+) end exceeds 128. 2. The relationship in magnitude among the inclination compensation point numbers is incorrect. 3. An inclination compensation point is not located between the negative (-) end and positive (+) end of the pitch error compensation points. 4. The amount of compensation per compensation point is too large or too small. Correct the parameter. |
| 5219 | CAN NOT RETURN | Manual intervention or return is not allowed during three-dimensional coordinate conversion. |

| Number | Message | Contents |
|--------|--|--|
| 5220 | REFERENCE POINT ADJUSTMENT MODE | A parameter for automatically set a reference position is set. (Bit 2 of parameter No. 1819 = 1) Perform automatic setting. (Position the machine at the reference position manually, then perform manual reference position return.) Supplementary: Automatic setting sets bit 2 of parameter No. 1819 to 0. |
| 5222 | SRAM CORRECTABLE ERROR | The SRAM correctable error cannot be corrected. Cause: A memory problem occurred during memory initialization. Action: Replace the master printed circuit board (SRAM module). |
| 5227 | FILE NOT FOUND | A specified file is not found during communication with the built-in Handy File. |
| 5228 | SAME NAME USED | There are duplicate file names in the built-in Handy File. |
| 5229 | WRITE PROTECTED | A floppy disk in the built-in Handy File is write protected. |
| 5231 | TOO MANY FILES | The number of files exceeds the limit during communication with the built-in Handy File. |
| 5232 | DATA OVER-FLOW | There is not enough floppy disk space in the built-in Handy File. |
| 5235 | COMMUNICATION ERROR | A communication error occurred during communication with the built-in Handy File. |
| 5237 | READ ERROR | A floppy disk in the built-in Handy File cannot be read from. The floppy disk may be defective, or the head may be dirty. Alternatively, the Handy File is defective. |
| 5238 | WRITE ERROR | A floppy disk in the built-in Handy File cannot be written to. The floppy disk may be defective, or the head may be dirty. Alternatively, the Handy File is defective. |
| 5242 | ILLEGAL AXIS NUMBER (M series) | The axis number of the synchronous master axis or slave axis is incorrect. (This alarm is issued when flexible synchronization is turned on.) Alternatively, the axis number of the slave axis is smaller than that of the master axis. |
| 5243 | DATA OUT OF RANGE (M series) | The gear ratio is not set correctly. (This alarm is issued when flexible synchronization is turned on.) |
| 5244 | TOO MANY DI ON (M series) | Even when an M code was encountered in automatic operation mode, the flexible synchronization mode signal was not driven on or off. Check the ladder and M codes. |
| 5245 | OTHER AXIS ARE COMMANDED (M series) | One of the following command conditions was present during flexible synchronization or when flexible synchronization was turned on: 1. The synchronous master axis or slave axis is the EGB axis. 2. The synchronous master axis or slave axis is the chopping axis. 3. In reference position return mode |
| 5251 | ILLEGAL PARAMETER IN G54.2 (M series) | A fixture offset parameter (No. 7580 to 7588) is illegal. Correct the parameter. |
| 5252 | ILLEGAL P COMMAND IN G54.2 (M series) | The P value specifying the offset number of a fixture offset is too large. Correct the program. |
| 5257 | G41/G42 NOT ALLOWED IN MDI MODE (M series) | G41/G42 (cutter compensation C: M series) was specified in MDI mode. (Depending on the setting of bit 4 of parameter No. 5008) |
| | G41/G42 NOT ALLOWED IN MDI MODE (T series) | G41/G42 (tool-nose radius compensation: T series) was specified in MDI mode. (Depending on the setting of bit 4 of parameter No. 5008) |

| Number | Message | Contents |
|--------|-------------------------------------|--|
| 5300 | SET ALL OFFSET DATAS AGAIN | After the inch/metric automatic conversion function (OIM: Bit 0 of parameter No. 5006) for tool offset data is enabled or disabled, all the tool offset data must be reset. This message reminds the operator to reset the data. If this alarm is issued, reset all the tool offset data. Operating the machine without resetting the data will result in a malfunction. |
| 5302 | ILLEGAL COMMAND IN G68 MODE | A command to set the coordinate system is specified in the coordinate system rotation mode. |
| 5303 | TOUCH PANEL ERROR | A touch panel error occurred. Cause: 1. The touch panel is kept pressed. 2. The touch panel was pressed when power was turned on. Remove the above causes, and turn on the power again. |
| 5306 | MODE CHANGE ERROR | In a one-touch macro call, mode switching at the time of activation is not performed correctly. |
| 5307 | INTERNAL DATA OVER FLOW (M series) | In the following function, internal data exceeds the allowable range. 1) Improvement of the rotation axis feedrate |
| 5311 | FSSB:ILLEGAL CONNECTION | A connection related to FSSB is illegal. This alarm is issued when either of the following is found: 1. Two axes having adjacent servo axis numbers (parameter No. 1023), odd number and even number, are assigned to amplifiers to which different FSSB systems are connected. 2. The system does not satisfy the requirements for performing HRV control, and use of two pulse modules connected to different FSSB systems having different FSSB current control cycles is specified. |
| 5321 | S-COMP. VALUE OVERFLOW | The straightness compensation value has exceeded the maximum value of 32767. After this alarm is issued, make a manual reference position return. |
| 5400 | SPL:ILLEGAL AXIS COMMAND (M series) | An axis specified for spline interpolation or smooth interpolation is incorrect. If an axis that is not the spline axis is specified in spline interpolation mode, this alarm is issued. The spline axis is the axis specified in a block containing G06.1 or the next block. For smooth interpolation, the axis specified in G5.1Q2 is incorrect. |
| 5401 | SPL:ILLEGAL COMMAND (M series) | In a G code mode in which specification of G06.1 is not permitted, G06.1 is specified. |
| 5402 | SPL:ILLEGAL AXIS MOVING (M series) | A movement is made along an axis that is not the spline interpolation axis. For example, in three-dimensional tool compensation mode using an offset vector of which components are the X-, Y-, and Z-axes, when two-axis spline interpolation is performed with the two spline axes set to the X- and Y-axes, a movement along the Z-axis occurs, resulting in this alarm. |
| 5403 | SPL:CAN NOT MAKE VECTOR (M series) | Three-dimensional tool compensation vectors cannot be generated. · When a three-dimensional tool compensation vector is created for the second or subsequent point, that point, previous point, and next point are on the same straight line, and that straight line and the three-dimensional tool compensation vector for the previous point are in parallel. · When a three-dimensional tool compensation vector is created at the end point of smooth interpolation or spline interpolation, the end point and the point two points before are the same. |

| Number | Message | Contents |
|--------|---|---|
| 5405 | ILLEGAL PARAMETER IN G41.2/ G42.2 (M series) | The parameter setting that determines the relationship between the rotation axis and rotation plane is incorrect. |
| 5406 | G41.3/G40 FORMAT ERROR (M series) | 1) A G41.3 or G40 block contains a move command. 2) A G1.3 block contains a G code or M code for which buffering is suppressed. |
| 5407 | ILLEGAL COMMAND IN G41.3 (M series) | 1) A G code that belongs to group 01 except G00 and G01 is specified in G41.3 mode. 2) An offset command (a G code belonging to group 07) is specified in G41.3 mode. 3) The block next to G41.3 (startup) contains no movement. |
| 5408 | G41.3 ILLEGAL START_UP (M series) | 1) In a mode of group 01 except G00 and G01, G41.3 (startup) is specified. 2) At startup, the included angle of the tool direction vector and move direction vector is 0 or 180 degrees. |
| 5409 | ILLEGAL PARAMETER IN G41.3 (M series) | The parameter setting (No. xxxx to xxxx) that determines the relationship between the rotation axis and rotation plane is incorrect. |
| 5411 | NURBS:ILLEGAL ORDER (M series) | The number of steps is specified incorrectly. |
| 5412 | NURBS:NO KNOT COMMAND (M series) | No knot is specified. Alternatively, in NURBS interpolation mode, a block not relating to NURBS interpolation is specified. |
| 5413 | NURBS:ILLEGAL AXIS COMMAND (M series) | An axis not specified with controlled points is specified in the first block. |
| 5414 | NURBS:ILLEGAL KNOT (M series) | The number of blocks containing knots only is insufficient. |
| 5415 | NURBS:ILLEGAL CANCEL (M series) | Although NURBS interpolation is not completed yet, the NURBS interpolation mode is turned off. |
| 5416 | NURBS:ILLEGAL MODE (M series) | A mode that cannot be used with NURBS interpolation mode is specified in NURBS interpolation mode. |
| 5417 | NURBS:ILLEGAL MULTI-KNOT (M series) | As many knots as the number of steps are not specified at the start and end points. |
| 5418 | NURBS:ILLEGAL KNOT VALUE (M series) | Knots do not increase in monotone. |
| 5420 | ILLEGAL PARAMETER IN G43.4/ G43.5 (M series) | A parameter related to pivot tool length compensation is incorrect. |
| 5421 | ILLEGAL COMMAND IN G43.4/ G43.5 (M series) | In pivot tool length compensation (type 2) mode, a rotation axis is specified. |
| 5422 | EXCESS VELOCITY IN G43.4/G43.5 (M series) | As a result of pivot tool length compensation, an attempt was made to move the tool along an axis at a feedrate exceeding the maximum cutting feedrate. |
| 5425 | ILLEGAL OFFSET VALUE (M series) | The offset number is incorrect. |
| 5430 | ILLEGAL COMMAND IN 3-D CIR (M series) | In a modal state in which three-dimensional circular interpolation cannot be specified, a three-dimensional circular interpolation (G02.4/G03.4) is specified. Alternatively, in three-dimensional circular interpolation mode, a code that cannot be specified is specified. |
| 5432 | G02.4/G03.4 FORMAT ERROR (M series) | A three-dimensional circular interpolation command (G02.4/G03.4) is incorrect. |
| 5433 | MANUAL INTERVENTION IN 3-D CIR (M series) | In three-dimensional circular interpolation mode (G02.4/G03.4), manual intervention was made when the manual absolute switch was on. |
| 5435 | PARAMETER OUT OF RANGE (TLAC) (M series) | Incorrect parameter setting (set value range) |
| 5436 | PARAMETER SETTING ERROR 1 (TLAC) (M series) | Incorrect parameter setting (setting of the rotation axis) |

| Number | Message | Contents |
|--------|---|--|
| 5437 | PARAMETER SETTING ERROR 2 (TLAC) (M series) | Incorrect parameter setting (setting of the tool axis) |
| 5440 | ILLEGAL DRILLING AXIS SELECTED (M series) | The drilling axis specified for the drilling canned cycle is incorrect. The G code command block of the canned cycle does not specify the Z point of the drilling axis. When there is a parallel axis with the drilling axis, the parallel axis is also specified at the same time. |
| 5445 | CRC:MOTION IN G39 (M series) | Corner circular interpolation (G39) of cutter compensation is not specified alone but is specified with a move command. |
| 5446 | CRC:NO AVOIDANCE (M series) | Because there is no interference evade vector, the interference check evade function of cutter compensation cannot evade interference. |
| 5447 | CRC:DANGEROUS AVOIDANCE (M series) | The interference check evade function of cutter compensation determines that an evade operation will lead to danger. |
| 5448 | CRC:INTERFERENCE TO AVD. (M series) | In the interference check evade function of cutter compensation, a further interference occurs for an already created interference evade vector. |
| 5452 | IMPROPER G-CODE (5AXISMODE) (M series) | A G code that cannot be specified is found. (5-axis mode) This alarm is issued when: <ol style="list-style-type: none"> 1) Three-dimensional cutter compensation (side-face offset and leading-edge offset) is applied during cutter compensation, or cutter compensation is applied during three-dimensional cutter compensation (side-face offset and leading-edge offset). 2) A leading-edge offset of three-dimensional cutter compensation is applied during side-face offsetting of three-dimensional cutter compensation, or a side-face offset of three-dimensional cutter compensation is applied during leading-edge offsetting of three-dimensional cutter compensation. 3) Tool axis direction tool length compensation is applied during tool length compensation, or tool length compensation is applied during tool axis direction tool length compensation. 4) Tool center point control is provided during tool length compensation, or tool length compensation is applied during tool center point control. 5) Tool center point control is provided during tool axis direction tool length compensation, or tool axis direction tool length compensation is applied during tool center point control. If this alarm is issued, cancel the relevant mode, then specify a different mode. |
| 5453 | NOTE: G68 IS CANCELED (HPCC) (M series) | When bit 2 of parameter No. 5400 is set to 1, and a reset does not cancel G68, this alarm is issued at the time of program restart. To release this alarm, press <RESET> and <CAN>. Once this operation is performed, the alarm will not be issued at the next restart. |
| 5455 | ILLEGAL ACC. PARAMETER (M series) | A permissible acceleration parameter for optimum torque acceleration/deceleration is incorrect. The cause is one of the following: <ol style="list-style-type: none"> 1) The ratio of the deceleration rate to the acceleration rate is below the limit. 2) The time required for deceleration to a speed of 0 exceeds the maximum value. |

NOTE

AICC designates AI Contour Control.

A.2 LIST OF ALARMS (PMC)

(1) PMC ALARMS/SYSTEM ALARMS (PMC-SB7)

| Alarm number | Faulty location/corrective action | Contents |
|--|---|---|
| ER01 PROGRAM DATA ERROR | <ol style="list-style-type: none"> 1) Re-input the sequence program. 2) Replace the master printed circuit board. | The sequence program is invalid. |
| ER02 PROGRAM SIZE OVER | <ol style="list-style-type: none"> 1) Reduce the sequence program. 2) Contact FANUC to have a larger number-of-Ladder-steps option specified. | The sequence program is too large. The sequence program is invalid. |
| ER03 PROGRAM SIZE ERROR (OPTION) | <ol style="list-style-type: none"> 1) Reduce the sequence program. 2) Contact FANUC to have a larger number-of-Ladder-steps option specified. | The sequence program exceeds the size specified by the number-of-Ladder-steps option. |
| ER04 PMC TYPE UNMATCH | Using an offline programmer, change the sequence program to that for the correct PMC type. | The setting of the type in the sequence program differs from the actual type. |
| ER06 PMC CONTROL SOFTWARE TYPE UNMATCH | Contact FANUC to specify certain PMC type | The combination of CNC system configuration and PMC type is invalid. (Example: PMC-SB5 is used for a 3-path CNC system.) |
| ER07 NO OPTION (LADDER STEP) | <ol style="list-style-type: none"> 1) Restore the backed up CNC parameter data. 2) Check the data sheet and re-input the CNC parameters. 3) Contact FANUC to specify a number-of-Ladder-steps option of the necessary size. | No number-of-Ladder-steps option is found. |
| ER08 OBJECT UNMATCH | <ol style="list-style-type: none"> 1) Contact FANUC. | An unsupported function is used in the sequence program. |
| ER09 PMC LABEL CHECK ERROR PLEASE TURN ON POWER AGAIN WITH PUSHING 'O' & 'Z'. (CLEAR PMC SRAM) | <ol style="list-style-type: none"> 1) Press and hold down the 'O' and 'Z' key combination, and turn the CNC back on. 2) When using the loader control function, power on the CNC again while pressing the "5" and "Z" keys. 3) Replace the backup battery. 4) Replace the master printed circuit board. | With a change in the PMC type, for example, the retention-type memory of the PMC must be initialized. |
| ER10 OPTION AREA NOTHING (xxxx) | Contact FANUC to reconfigure the PMC management software. | The PMC management software is not loaded correctly. |
| ER11 OPTION AREA NOTHING (xxxx) | Contact FANUC to reconfigure the PMC management software. | The PMC C board management software is not loaded correctly. |

| Alarm number | Faulty location/corrective action | Contents |
|---|---|--|
| ER12 OPTION AREA ERROR (xxxx) | Contact FANUC to reconfigure the PMC management software. | The PMC management software is invalid. (The series of BASIC and OPTION do not match.) |
| ER13 OPTION AREA ERROR (xxxx) | Contact FANUC to reconfigure the PMC management software. | The PMC C board management software is invalid. (The series of BASIC and OPTION do not match.) |
| ER14 OPTION AREA VERSION ERROR (xxxx) | Contact FANUC to reconfigure the PMC management software. | The PMC management software is invalid. (The editions of BASIC and OPTION do not match.) |
| ER15 OPTION AREA VERSION ERROR (xxxx) | Contact FANUC to reconfigure the PMC management software | The PMC C board management software is invalid. (The editions of BASIC and OPTION do not match.) |
| ER16 RAM CHECK ERROR (PROGRAM RAM) | Replace the master printed circuit board. | The initialization of the memory used to store the sequence program failed. |
| ER17 PROGRAM PARITY | 1) Re-input the sequence program. 2) Replace the master printed circuit board. | The parity of the sequence program is invalid. |
| ER18 PROGRAM DATA ERROR BY I/O | Re-input the sequence program. | While the sequence program was being read, an interrupt command was generated. |
| ER19 LADDER DATA ERROR | Display the Ladder edit screen again and exit from editing by using the [<<] key. | During Ladder editing, the system was forcibly switched to the CNC screen with a function key. |
| ER20 SYMBOL/COMMENT DATA ERROR | Display the symbol/comment edit screen again and exit from editing by using the [<<] key. | During symbol/comment editing, the system was forcibly switched to the CNC screen with a function key. |
| ER21 MESSAGE DATA ERROR | Display the message data edit screen again and exit from editing by using the [<<] key. | During message data editing, the system was forcibly switched to the CNC screen with a function key. |
| ER22 PROGRAM NOTHING | 1) Re-input the sequence program. 2) Replace the master printed circuit board. | The sequence program is empty. |
| ER23 PLEASE TURN OFF POWER | Turn the CNC off and then back on. | With a change in the PMC type, for example, the power must be turned off and then back on. |
| ER25 SOFTWARE VERSION ERROR (PMCAOPT) | Contact FANUC to reconfigure the PMC management software. | The PMC management software is invalid. (The edition of PMCAOPT does not match.) |
| ER26 PMC CONTROL MODULE ERROR (PMCAOPT) | 1) Contact FANUC to reconfigure the PMC management software. 2) 2) Replace the master printed circuit board. | The initialization of the PMC management software failed. |

| Alarm number | Faulty location/corrective action | Contents |
|---|---|--|
| ER27 LADDER FUNC. PRM IS OUT OF RANGE | Modify the sequence program. Change the parameter number of the function instruction to a value within the valid range. | An out-of-range parameter number is specified with function instruction TMR, TMRB, CTR, DIFU, or DIFD. |
| ER32 NO I/O DEVICE | <ol style="list-style-type: none"> 1) Check that the I/O device is on. 2) Check that the I/O device was turned on before the CNC was turned on. 3) Check the connection of the cable. | An I/O device such as the I/O Link, connection unit, and Power Mate is not connected. |
| ER33 I/O LINK ERROR | Replace the master printed circuit board. | The LSI of the I/O Link is defective. |
| ER34 I/O LINK ERROR (xx) | <ol style="list-style-type: none"> 1) Check the connection of the cable leading to a device in group xx. 2) Check that the I/O device was turned on before the CNC. 3) Replace that device in group xx in which the PMC control module is installed. | In a slave in group xx, an error occurred in communication with an I/O device. |
| ER35 TOO MUCH OUTPUT DATA IN GROUP (xx) | Reduce the amount of output data in group xx. | The amount of output data in I/O Link group xx exceeds the limit (33 bytes). The excess data is nullified. |
| ER36 TOO MUCH INPUT DATA IN GROUP (xx) | Reduce the amount of input data in group xx | The amount of input data in I/O Link group xx exceeds the limit (33 bytes). The excess data is nullified. |
| ER38 MAX SETTING OUTPUT DATA OVER (xx) | Modify the total amount of output data in each group to 128 bytes or less. | The I/O Link I/O area is insufficient. (The allocation of any group after group xx on the output side is nullified.) |
| ER39 MAX SETTING INPUT DATA OVER (xx) | Modify the total amount of input data in each group to 128 bytes or less. | The I/O Link I/O area is insufficient. (The allocation of any group after group xx on the input side is nullified.) |
| ER40 I/O LINK-II SETTING ERROR (CHx) | Reconfigure the I/O Link-II. | The I/O Link-II setting is invalid. (CH1: Primary board, CH2: Secondary board) |
| ER41 I/O LINK-II MODE ERROR (CHx) | Reconfigure the I/O Link-II. | The I/O Link-II mode setting is invalid. (CH1: Primary board, CH2: Secondary board) |
| ER42 I/O LINK-II STATION NO.ERROR (CHx) | Reconfigure the I/O Link-II. | The I/O Link-II station number setting is invalid. (CH1: Primary board, CH2: Secondary board) |
| ER97 I/O LINK (CHxyyGROUP) | <ol style="list-style-type: none"> 1) Check whether the cables of I/O devices in group yy are connected properly. 2) Check the power to each I/O device. 3) Check the parameter setting of the I/O link assignment data selection function. | <p>The number of assigned I/O modules in group yy differs from that of I/O devices actually connected.</p> <p>Note) This alarm can control how the check function operates through the use of keep relay K906.2. K906.2 = 0: Connection check is performed (initial value). K906.2 = 1: Connection check is not performed.</p> |

| Alarm number | Faulty location/corrective action | Contents |
|---------------------------------|---|---|
| ER98 ILLEGAL LASER CONNECTION | Modify the allocation of the I/O module. | When an I/O device for a laser is used, the allocation of the I/O module does not match the actual I/O device configuration. |
| ER99 X,Y96-127 ARE ALLOCATED | Modify the allocation of the I/O module. | When an I/O device for a laser is used, another I/O device is allocated to X96-127/Y96-127. X96-127/Y96-127 are used for I/O devices for a laser, and cannot be used for other devices. |
| WN02 OPERATE ADDRESS ERROR | Modify the setting of the PMC system parameter, address of the operator's panel for Series 0. | The setting of the PMC system parameter, address of the operator's panel for Series 0, is invalid. |
| WN03 ABORT NC-WINDOW/EXIN | <ol style="list-style-type: none"> 1) Check that the Ladder program is free from problems and then restart the Ladder program (by pressing the RUN key). 2) Turn the CNC off and then back on. | The Ladder program was stopped during communication between the CNC and PMC. Function instructions such as WINDR, WINDW, EXIN, and DISPB may not be executed normally. |
| WN05 PMC TYPE NO CONVERSION | Using an offline programmer, change the sequence program to that for the correct PMC type. | The setting of the type in the sequence program differs from the actual type. (Example: For the PMC-SB5, the Ladder program of the PMC-SA3/SA5 was transferred.) |
| WN06 TASK STOPPED BY DEBUG FUNC | To restart a user task that has been stopped, stop the sequence program and then execute it again. | When a PMC C board is used, a user task has been stopped due to a break by a debug function. |
| WN07 LADDER SP ERROR (STACK) | Modify the sequence program so that the subprogram nesting level is eight or less. | For a subprogram call with the function instruction CALL or CALLU, the nesting level is too deep (exceeds 8). |
| WN17 NO OPTION (LANGUAGE) | <ol style="list-style-type: none"> 1) Restore the backed up parameter data. 2) Check the data sheet and re-input the parameters. 3) Contact FANUC to specify a PMC C program option of the necessary size. | When a PMC C board is used, no PMC C program option is found. |
| WN18 ORIGIN ADDRESS ERROR | <ol style="list-style-type: none"> 1) On the PMC system parameter screen, press [ORIGIN]. 2) Set the PMC system parameter, LANGUAGE ORIGIN, to the address indicated by the RC_CTLB_INIT in the map file. | When a PMC C board is used, the PMC system parameter, LANGUAGE ORIGIN, is invalid. |
| WN19 GDT ERROR (BASE, LIMIT) | Modify the setting in the user-defined GDT in the link control statement or build file. | When a PMC C board is used, the BASELIMIT or ENTRY in the user-defined GDT is invalid. |
| WN20 COMMON MEM. COUNT OVER | Change the number of shared memories to eight or less. Modify the link control statement, build file, or other source files for shared memories. | When a PMC C board is used, the number of shared memories exceeds eight. |

| Alarm number | Faulty location/corrective action | Contents |
|---------------------------------|--|---|
| WN21 COMMON MEM. ENTRY ERROR | Modify the ENTRY in the shared memory GDT in the link control statement. | When a PMC C board is used, the ENTRY in the shared memory GDT is out of range. |
| WN22 LADDER 3 PRIORITY ERROR | Change the value of the TASK LEVEL (LADDER LEVEL 3) in the link control statement to 0, 10 to 99, or -1. | When a PMC C board is used, the priority of LADDER LEVEL 3 is out of range. |
| WN23 TASK COUNT OVER | Change the TASK COUNT in the link control statement to 16 or less. (To change the task count, modify the link control statement, build file, and the configuration of the files to be linked.) | When a PMC C board is used, the number of user tasks exceeds 16. |
| WN24 TASK ENTRY ADDR ERROR | Change the GDT table in the build file to 32 (20H) to 95 (5FH). | When a PMC C board is used, the user task entry address selector is out of range. |
| WN25 DATA SEG ENTRY ERROR | Change the DATA SEGMENT GDT ENTRY value in the link control statement and the GDT table in the build file to 32 (20H) to 95 (5FH). | When a PMC C board is used, the data segment entry address is out of range. |
| WN26 USER TASK PRIORITY ERROR | Change the TASK LEVEL of each task in the link control statement to a value from 10 to 99 or -1. (Note that -1 can be specified for the TASK LEVEL of only one task, including the third Ladder level). | When a PMC C board is used, the priority of the user task is out of range. |
| WN27 CODE SEG TYPE ERROR | Change the value of the code segment according to the segment setting in the link control statement and build file. | When a PMC C board is used, the code segment type is invalid. The setting of the RENA-MESEG code segment in the bind control file is wrong. |
| WN28 DATA SEG TYPE ERROR | Change the value of the data segment according to the segment setting in the link control statement and build file. | When a PMC C board is used, the data segment type is invalid. The setting of the RENA-MESEG data segment in the bind control file is wrong. |
| WN29 COMMON MEM SEG TYPE ERROR | Change the value according to the segment setting in the link control statement and build file. | When a PMC C board is used, the shared memory segment type is invalid. The setting of the RENAMESSEG segment in the shared memory bind control file is wrong. |
| WN30 IMPOSSIBLE ALLOCATE MEM. | <ol style="list-style-type: none"> 1) Check that the USER GDT ADDRESS in the link control statement and the start address of the code segment in the build file are correct. 2) Change the PMC system parameter, MAX LADDER AREA SIZE, to a minimum. 3) Change the stack size in the link control state to a minimum. | When a PMC C board is used, the memory area for data, stacks, and others cannot be reserved. |
| WN31 IMPOSSIBLE EXECUTE LIBRARY | <ol style="list-style-type: none"> 1) Check the types supported by the library. 2) Reconfigure the PMC management software and contact FANUC. | When a PMC C board is used, library functions cannot be executed. |

| Alarm number | Faulty location/corrective action | Contents |
|--|--|--|
| WN32 LNK CONTROL DATA ERROR | <ol style="list-style-type: none"> 1) Check that the address of RC_CTLNB_INIT is set for the PMC system parameter, LANGUAGE ORIGIN. 2) Create the link control statement again. | When a PMC C board is used, link control statement (program control) data is invalid. |
| WN33 LNK CONTROL VER.ERROR | Modify the link control statement in the PMC C program. | When a PMC C board is used, a link control statement data edition error has occurred. |
| WN34 LOAD MODULE COUNT OVER | Change the number of independent load modules to eight or less. | When a PMC C board is used, the number of independent load modules exceeds eight. |
| WN35 CODE AREA OUT OF RANGE | Check the link map and allocate segments within the range of RAM. | When a PMC C board is used, the code segment area is out of the range of the RAM. |
| WN36 LANGUAGE SIZE ERROR (OPTION) | <ol style="list-style-type: none"> 1) Reduce the PMC C program. 2) Contact FANUC to specify a PMC C program option of a larger size. | When a PMC C board is used, the PMC C program exceeds the size specified for the PMC C program option. |
| WN37 PROGRAM DATA ERROR (LANG.) | Initialize the PMC C program memory. ([EDIT] → [CLEAR] → [CLRLNG] → [EXEC]) | The PMC C program memory must be initialized. |
| WN38 RAM CHECK ERROR (LANG.) | Replace the master printed circuit board. | The initialization of the PMC C program memory failed. |
| WN39 PROGRAM PARITY (LANG.) | <ol style="list-style-type: none"> 1) Re-input the PMC C program. 2) Replace the master printed circuit board. | The parity of the PMC C program parity is invalid. |
| WN40 PROGRAM DATA ERROR BY I/O (LANG.) | Re-input the language program. | While the PMC C program was being read, an interrupt command was generated. |
| WN41 LANGUAGE TYPE UNMATCH | <ol style="list-style-type: none"> 1) Re-input the PMC C program. 2) Replace the master printed circuit board. | When a PMC C board is used, an unusable C program is input. |
| WN42 UNDEFINE LANGUAGE ORIGIN ADDRESS | <ol style="list-style-type: none"> 1) On the PMC system parameter screen, click [ORIGIN]. 2) Set the PMC system parameter, LANGUAGE ORIGIN, to the address indicated by the RC_CTLNB_INIT in the map file. | When a PMC C board is used, the PMC parameter, LANGUAGE ORIGIN, is not set. |
| WN48 UNAVAIL LANGUAGE BY CNC UNMATCH | Remove the PMC C board. | A PMC C board is installed in a CNC in which a PMC C board cannot be used. |

(2) Alarm messages (PMC-SA1)

| Message | Contents and solution |
|--|---|
| ALARM NOTHING | Normal status |
| ER01 PROGRAM DATA ERROR | The sequence program is defective. (solution) Please input LADDER again. |
| ER02 PROGRAM SIZE OVER | The size of sequence program exceeds the maximum size of LADDER. (solution) Please change MAX LADDER AREA SIZE at the SYSPRM screen and restart the system. |
| ER03 PROGRAM SIZE ERROR(OPTION) | The size of sequence program exceeds the option specification size. (solution) Please increase the option specification size. Or, reduce the size of sequence program. |
| ER04 PMC TYPE UNMATCH | The PMC model setting of the sequence program is not corresponding to an actual model. (solution) Please change the PMC model setting by the offline programmer. |
| ER05 PMC MODULE TYPE ERROR | The module type of the PMC engine is not correct. (solution) Please exchange the module of PMC engine for a correct one. |
| ER06 PMC CONTROL SOFTWARE TYPE UNMATCH | The combination of CNC system configuration and PMC type is invalid. PMC-SB5 is used for a 3-path CNC system. (solution) Contact FANUC. |
| ER07 NO OPTION (LADDER STEP) | There is no step number option of LADDER. |
| ER10 OPTION AREA NOTHING (series name) | The management software for the PMC-SA/SB has not been transferred. (solution) The software installation is not consistent with the order. Contact FANUC. |
| ER11 OPTION AREA NOTHING (series name) | The management software for the PMC C board has not been transferred. (solution) The software installation is not consistent with the order. Contact FANUC. |
| ER12 OPTION AREA ERROR (series name) | The series of the management software for the PMC-SA/SB differs between BASIC and OPTION. (solution) Contact FANUC. |
| ER13 OPTION AREA ERROR (series name) | The series of the management software for the PMC C board differs between BASIC and OPTION. (solution) Contact FANUC. |
| ER14 OPTION AREA VERSION ERROR (series name) | The edition of the management software for the PMC-SA/SB differs between BASIC and OPTION. (solution) Contact FANUC. |
| ER15 OPTION AREA VERSION ERROR (series name) | The edition of the management software for the PMC C board differs between BASIC and OPTION. (solution) Contact FANUC. |
| ER16 RAM CHECK ERROR (PROGRAM RAM) | The debugging RAM cannot be read/written normally. (solution) Please exchange the debugging RAM. |
| ER17 PROGRAM PARITY | The parity error occurred on ROM for sequence program or the debugging RAM. (solution) ROM: The deterioration of ROM may be deteriorated Please exchange ROM for the sequence program RAM: Please edit the sequence program once on PMC Still the error occurs, exchange the debugging RAM. |
| ER18 PROGRAM DATA ERROR BY I/O | Transferring the sequence program from offline programmer was interrupted by the power off etc. (solution) Please clear the sequence program and transfer the sequence program again. |

| Message | Contents and solution |
|---------------------------------------|---|
| ER19 LADDER DATA ERROR | Editing the LADDER was interrupted by the power off or by the switch to the CNC screen by the function key etc. (solution) Please edit LADDER once on PMC. Or, please input LADDER again. |
| ER20 SYMBOL/COMMENT DATA ERROR | Editing the symbol and comment was interrupted by the power off or by the switch to the CNC screen by the function key etc. (solution) Please edit symbol and comment once on PMC. Or, please input symbol and comment again. |
| ER21 MESSAGE DATA ERROR | Editing the message data was interrupted by the power off or the switch to the CNC screen by the function key etc. (solution) Please edit message data once on PMC. Or, please input message data again. |
| ER22 PROGRAM NOTHING | There is no sequence program |
| ER23 PLEASE TURN OFF POWER | There is a change in setting LADDER MAX AREA SIZE etc. (solution) Please restart the system to make the change effective. |
| ER24 LADDER, LANGUAGE AREA OVERLAP | The C program area overlaps the ladder program area. (solution) Adjust the address range assigned to C programs. |
| ER25 SOFTWARE VERSION ERROR (PMCAOPT) | The PMC-SA/SB management software editions are inconsistent. (solution) Contact FANUC. |
| ER26 SOFTWARE VERSION ERROR (PMCAOPT) | The PMC-SA/SB management software cannot be initialized. (solution) Contact FANUC. |
| ER27 LADDER FUNC. PRM IS OUT OF RANGE | The parameter number for function instruction TMR, TMRB, CTR, DIFU, or DIFD is not in the range. (solution) Correct the number so that it is within the range. |

*When ER00 to ER27 occur, sequence program is not available.

| Message | Contents and solution |
|--|--|
| ER32 NO I/O DEVICE | Any DI/DO unit of I/O Unit or the connection unit etc. is not connected. When built-in I/O card is connected, this message is not displayed. (solution) When built-in I/O card is used: Please confirm whether the built-in I/O card is certainly connected with. When I/O Link is used: Please confirm whether the I/O units turning on. Or please confirm the connection of the cable. |
| ER33 SLC ERROR | The LSI for I/O Link is defective. (solution) Please exchange the motherboard. |
| ER34 SLC ERROR(xx) | The communication with the DI/DO units of the xx group failed. (solution) Please confirm the connection of the cable connected to the I/O units of the xx group. Please confirm whether the I/O units turned on earlier than CNC and PMC. Or, please exchange the module of PMC engine on the I/O units of the xx group |
| ER35 TOO MUCH OUTPUT DATA IN GROUP(xx) | The number of the output data in the xx group exceeded the max. The data, which exceed 32 bytes, become ineffective. (solution) Please refer to the following for the number of the data for each group. "FANUC I/O Unit-MODEL A connecting and maintenance manual" (B-61813E) "FANUC I/O Unit-MODEL B connecting manual"(B-62163E) |

| Message | Contents and solution |
|---------------------------------------|---|
| ER36 TOO MUCH INPUT DATA IN GROUP(xx) | The number of the input data in the xx group exceeded the max. The data, which exceed 32 bytes, become ineffective. (solution) Please refer to the following for the number of the data for each group. "FANUC I/O Unit-MODEL A connecting and maintenance manual" (B-61813E) "FANUC I/O Unit-MODEL B connecting manual"(B-62163E) |
| ER38 MAX SETTING OUTPUT DATA OVER(xx) | The assignment data for a group exceeds 128 bytes. (The assignment data of output side of xx group or later become ineffective.) (solution) Please reduce the assignment data to 128 bytes or less for the number of the output data of each group. |
| ER39 MAX SETTING INPUT DATA OVER(xx) | The assignment data for a group exceeds 128 bytes. (The assignment data of input side of xx group or later become ineffective.) (Solution) Please reduce the assignment data to 128 bytes or less for the number of the input data of each group. |
| ER98 ILLEGAL LASER CONNECTION | An I/O unit for the laser and assigned data do not match. (solution) Check that the ladder assignment data and actual I/O units match. |
| ER99 X, Y96-127 ARE ALLOCATED | When the laser I/O link is provided, ladder I/O is assigned to X96-X127 and Y96-Y127. (solution) Delete the data assigned to X96-X127 and Y96-Y127. |
| WN02 OPERATE PANEL ADDRESS ERROR | The address setting data of the operator's panel for FS-0 is illegal. (solution) Please correct the address setting data. |
| WN03 ABORT NC-WINDOW/ EXIN | LADDER was stopped while CNC and PMC were communicating. The functional instruction WINDR, WINDW, EXIN, DISPB, and etc. may not work normally. (solution) When restarting the system, this alarm will be released. Execute the sequence program(Press RUN key) after confirming whether there is a problem in LADDER or not. |
| WN04 UNAVAIL EDIT MODULE | The LADDER editing module cannot be recognized.(PMC-SA _x /SB _{xx} =1 to 3) (solution) Please confirm the slot position installed. Please confirm the installed module. |
| WN05 PMC TYPE NO CONVERSION | A ladder program for the PMC-SA3/SA5 was transferred to the PMC-SB5. (solution) Correct the ladder type. |
| WN06 TASK STOPPED BY DEBUG FUNC | Some user tasks are stopped by break point of the debugging function. |
| WN07 LADDER SP ERROR (STACK) | When functional instruction CALL(SUB65) or CALLU(SUB66) was executed, the stack of the LADDER overflowed. (solution) Please reduce the nesting of the subprogram to 8 or less. |
| WN17 NO OPTION (LANGUAGE) | There is no C language option. |
| WN18 ORIGIN ADDRESS ERROR | The LANGUAGE ORIGIN address of the system parameter is wrong (solution) Please set the address of symbol RC_CTLB_INIT in the map file to the LANGUAGE ORIGIN of the system parameter. |
| WN19 GDT ERROR (BASE,LIMIT) | The value of BASE, LIMIT or ENTRY of user defined GDT is illegal. (solution) Please correct the address in link control statement and build file. |
| WN20 COMMON MEM. COUNT OVER | The number of common memories exceeds 8. (solution) Please reduce the number of common memories to 8 or less. It is necessary to correct a link control statement,build file and the source file for the common memory. |

| Message | Contents and solution |
|---------------------------------|---|
| WN21 COMMON MEM. ENTRY ERROR | GDT ENTRY of the common memory is out of range. (solution) Please correct the address of GDT ENTRY of the common memory in the link control statement. |
| WN22 LADDER 3 PRIORITY ERROR | The priority of LADDER LEVEL 3 is out of range. (solution) Please correct the value of LADDER LEVEL 3 in the link control statement within the range of 0 or 10–99 or –1. |
| WN23 TASK COUNT OVER | The number of user tasks exceeds 16. (solution) Please confirm TASK COUNT in the link control statement. When the number of tasks is changed, it is necessary to correct the link control statement, build file and the composition of the files to be linked. |
| WN24 TASK ENTRY ADDR ERROR | The selector of the entry address to the user task is out of range. (solution) Please correct the table of GDT in build file to the value within 32(20H)–95(5FH). |
| WN25 DATA SEG ENTRY ERROR | The entry address of the data segment is out of range. (solution) Please correct DATA SEGMENT GDT ENTRY in the link control statement and the table of GDT in build file within 32(20H)–95(5FH). |
| WN26 USER TASK PRIORITY ERROR | The priority of the user task is out of range. (solution) Please correct the TASK LEVEL in link control statement within the range of 10–99 or –1. Note: Only one task can have TASK LEVEL –1 (including LADDER LEVEL 3). |
| WN27 CODE SEG TYPE ERROR | The code segment type is illegal. The code segment of RENAMESSEG in the binding control file is wrong. (solution) Please correct the entry of the code segment in the link control statement to correspond to the entry in the build file. |
| WN28 DATA SEG TYPE ERROR | The data segment type is illegal. The data segment of RENAMESSEG in the binding control file is wrong. (solution) Please correct the entry of the code segment in the link control statement to correspond to the entry in the build file. |
| WN29 COMMON MEM SEG TYPE ERROR | The segment type of common memory is illegal. The segment of RENAMESSEG in the building control file of the common memory is wrong. (solution) Please correct the entry of common memory in the link control statement to correspond to the entry in the build file. |
| WN30 IMPOSSIBLE ALLOCATE MEM. | The memories for the data and stack etc. cannot be allocated. (solution) Please confirm whether the value of code segment in build file and USER GDT ADDRESS in link control statement is correct or not. Or please reduce the value of MAX LADDER AREA SIZE of the system parameter and the size of the stack in link control statement at the least |
| WN31 IMPOSSIBLE EXECUTE LIBRARY | The library function cannot be executed. (solution) Please confirm the object model of the library. Or, system ROM of PMC must be replaced with one of later version. |
| WN32 LNK CONTROL DATA ERROR | Link control statement data is illegal. (solution) Please confirm whether the address of symbol RC_CTLB_INIT in map file is set to LANGUAGE ORIGIN of the system parameter. Or, please make the link control statement again. |
| WN33 LNK CONTROL VER. ERROR | A link control statement data version error occurred. (Solution) Correct the link control statement in the C program. |
| WN34 LOAD MODULE COUNT OVER | The number of independent load modules exceeds eight. (solution) Decrease the number of independent load modules to eight or smaller. |

| Message | Contents and solution |
|--|---|
| WN35 CODE AREA OUT OF RANGE | The specified code area is beyond the address range. (solution) Correct the C program. |
| WN36 LANGUAGE SIZE ERROR (OPTION) | The size of a C program exceeds the option size. (solution) Decrease the size of the C program. |
| WN37 PROGRAM DATA ERROR (LANG.) | A C program is destroyed. (solution) Transfer the C program again. |
| WN38 RAM CHECK ERROR (LANG.) | A C program is destroyed. (solution) Transfer the C program again. |
| WN39 PROGRAM PARITY (LANG.) | A parity mismatch occurred in a C program. (solution) Transfer the C program again. |
| WN40 PROGRAM DATA ERROR BY I/O (LANG.) | Transfer of a C program was interrupted by, for example, a power failure. (solution) Clear the C program, then transfer the C program again. |
| WN41 LANGUAGE TYPE UNMATCH | A C program type mismatch occurred. (solution) Correct the C program. |
| WN42 UNDEFINE LANGUAGE ORIGIN ADDRESS | No language origin address is set. (solution) Set the language origin address. |

NOTE

Alarms WN17 to WN42 indicate errors related to PMC user C programs.

(3) System alarm messages (PMC-SB7)

| | Message | Contents and solution |
|---|--|---|
| 1 | PC004 CPU ERR xxxxxxx:yyyyyyy PC006 CPU ERR xxxxxxx:yyyyyyy PC009 CPU ERR xxxxxxx:yyyyyyy PC010 CPU ERR xxxxxxx:yyyyyyy | A CPU error occurred in the PMC. xxxxxxx and yyyyyyy indicate internal error code. If this error occurs, the motherboard may be faulty. Replace the motherboard, then check whether the error recurs. If the error still occurs even after the replacement of the motherboard, report the conditions under which the error occurred (system configuration, operation, time and frequency of error occurrences, etc.) to FANUC. |
| 2 | PC030 RAM PARITY aa:bb | A RAM parity error occurred in the PMC. aa and bb indicate internal error code. If this error occurs, the motherboard may be faulty. Solution) Replace the motherboard, then check whether the error recurs. If the error still occurs even after the replacement of the motherboard, report the conditions under which the error occurred (system configuration, operation, time and frequency of error occurrences, etc.) and the indicated internal error code to FANUC. |
| 3 | PC050 I/OLINK(CHx) aa:bb-aa:bb or PC050 IOLINK CHx aabb- aabb:aabb | A communication error occurred in the I/O Link. CHx is channel number. aa and bb indicate internal error code. If this error occurs, the possible causes are as follows: (1) Although the base expansion is assigned when the I/O Unit A is used, the base is not connected. (2) A cable is not connected securely. (3) Cabling is faulty. (4) I/O equipment (I/O unit, Power Mate, etc.) is faulty. (5) The power to the master or slave unit of the I/O Link is disconnected. (6) A DO-pin short-circuit occurred in an I/O device. (7) The motherboard is faulty. Solution) (1) Check whether the I/O assignment data and the actual I/O equipment connection match. (2) Check whether the cables are connected correctly. (3) According to "FANUC I/O Unit-MODEL A Connection and Maintenance Manual" (B-61813E) or "FANUC I/O Unit-MODEL B Connection manual" (B-62163E), check for an error in the cable specifications. (4) Replace the I/O unit interface module, cable, or motherboard. Then, check whether the error still occurs. |
| 4 | PC060 FBUS xxxxxxx:yyyyyyy PC061 FL-R xxxxxxx:yyyyyyy PC062 FL-W aa: xxxxxx:yyyyyyy | A bus error occurred in the PMC. aa, xxxxxx, and yyyyyyy indicate internal error code. If this error occurs, the hardware may be faulty. Solution) Report the conditions under which the error occurred (system configuration, operation, time and frequency of error occurrences, tc.), the indicated internal error code, and the LED status on each board to FANUC. |

| | Message | Contents and solution |
|---|---|---|
| 5 | PC070 SUB65 CALL (STACK) | <p>A stack error occurred during execution of ladder function instruction CALL/CALLU.</p> <p>Solution) Check the correspondence between the CALL/CALLU instruction and SPE instruction. If the error cannot be located, report the conditions under which the error occurred and the ladder program to FANUC.</p> |
| 6 | PC080 SYS EMG xxxxxxxx:yyyyyyyy PC081 FL EMG xxxxxxxx:yyyyyyyy | <p>A system alarm was caused by another software.</p> <p>Solution) Report the conditions under which the error occurred (system configuration, operation, time and frequency of error occurrences, etc.), the indicated internal error code, and the LED status on each board to FANUC.</p> |
| 7 | PC097 PARITY ERR (LADDER) PC098 PARITY ERR (DRAM) | <p>A parity error occurred in the PMC system.</p> <p>If this error occurred, the motherboard may be faulty.</p> <p>Solution) Replace the motherboard, then check whether the error recurs. If the error still occurs even after the replacement of the motherboard, report the conditions under which the error occurred (system configuration, operation, time and frequency of error occurrences, etc.) to FANUC.</p> |

(4) System alarm messages (for the C language board)

| | Message | Contents and solution |
|---|--|--|
| 1 | PC1nn CPU INTERRT xxxxyyyyyy STATUS LED ☆☆ | CPU error (abnormal interrupt) nn : Exception code Exception code of the i80486. For details, refer to the relevant manual that describes the CPU. 00 Division error. For example, the divisor in a division instruction is 0. 12 Stack exception caused by, for example, stack segment limit violation 13 General protection exception generated when, for example, a segment limit is exceeded xxxx : Segment selector where the system error occurred A value 0103 to 02FB indicates the C execution area. yyyyyy : Offset address at which the system error occurred (Solution) If a C program is not used, or if the cause of the error cannot be determined even by checking the C program, contact FANUC. |
| 2 | PC130 RAM PRITY aa xxxxyyyyyy STATUS LED □☆ | A parity error occurred in user RAM or DRAM on the C language board. aa : RAM parity error occurrence information xxxx : Segment selector where the system error occurred yyyyyy : Offset address at which the system error occurred |
| 5 | PC160 F-BUS ERROR xxxxyyyyyy PC161 F-BUS ERROR xxxxyyyyyy PC162 F-BUS ERROR xxxxyyyyyy STATUS LED ☆□ | A bus error occurred on the C language board. xxxx : Segment selector where the system error occurred yyyyyy : Offset address at which the system error occurred |
| 6 | PC170 F-BUS ERROR xxxxyyyyyy PC171 F-BUS ERROR xxxxyyyyyy PC172 F-BUS ERROR xxxxyyyyyy STATUS LED ☆□ | A bus error occurred on the C language board. xxxx : Segment selector where the system error occurred yyyyyy : Offset address at which the system error occurred |
| 7 | PC199 ROM PARITY eeeeeeee STATUS LED ☆☆ | A parity error occurred in system ROM on the C language board. eeeeeeee : ROM parity error information |

STATUS LED (green)

□ : Off ■ : On ☆☆ : Blink

(5) Alarm messages (For EDIT: PMC-SB7)

Messages displayed during update of the PMC ladder diagram editing

| Alarm number | Faulty location/corrective action | Contents |
|--|--|--|
| OVERLAPPED COM | If COME is missing, add it in proper position. If the COM is unnecessary, remove it. | There is no COME that corresponds to this COM. |
| END IN COM END1 IN COM END2 IN COM | If COME is missing, add it in proper position. If COM is unnecessary, remove it. | END, END1, END2, or END3 is found between COM and COME. |
| JMPE IN COM | JMPE and corresponding JMP must have same COM/COME status. Review JMP range and COM range, to adjust not to overlap with each other: it is possible that one range includes the other completely. | JMPE is found between COM and COME, and JMP and corresponding JMPE have different COM/COME status. |
| SP/SPE IN COM | If COME is missing, add it in proper position. If the COM is unnecessary, remove it. | SP or SPE is found between COM and COME. |
| COME WITHOUT COM | If COM is missing, add it in proper position. If the COME is unnecessary, remove it. | There is no COM that corresponds to this COME. |
| DUPLICATE CTR NUMBER (WARNING) | If some of them are unnecessary, remove them. If all of them are necessary, assign other number to parameter of them to make them unique. (If two or more instructions with same parameter number will never be active simultaneously at one time, the Ladder program has a possibility to work correctly, however, it is recommended from safety and maintenance points of view, that all these instructions should have different parameter number with each other.) | Plural CTRs have the same number as their parameter. (This is warning.) |
| ILLEGAL CTR NUMBER | If unnecessary, remove it. Assign correct number not to exceed the maximum number defined by each PMC model. | CTR has parameter number that is out of range. |
| DUPLICATE DIFU/DIFD NUMBER (WARNING) | If some of them are unnecessary, remove them. If all of them are necessary, assign other number to parameter of them to make them unique. (If two or more instructions with same parameter number will never be active simultaneously at one time, the Ladder program has a possibility to work correctly, however, it is recommended from safety and maintenance points of view, that all these instructions should have different parameter number with each other.) | Plural DIFUs or DIFDs have the same number as their parameter. (This is warning.) |
| ILLEGAL DIFU/DIFD NUMBER | If unnecessary, remove it. Assign correct number not to exceed the maximum number defined by each PMC model. | DIFU or DIFD has parameter number that is out of range. |
| NO END NO END1 NO END2 NO END3 | Add END, END1, END2 or END3 in proper position. | END, END1, END2 or END3 is not found. |

| Alarm number | Faulty location/corrective action | Contents |
|---|---|--|
| DUPLICATE END1 DUPLICATE END2 DUPLICATE END3 | Remove extra END1, END2 or END3. | Multiple END1, END2 or END3 are found. |
| GARBAGE AFTER END GARBAGE AFTER END2 GARBAGE AFTER END3 | Remove unnecessary nets, and move necessary nets to proper position so that they will be executed. | There are some nets after END, END2 or END3, which will not be executed. |
| OVERLAPPED JMP | If JMPE is missing, add it in proper position. If the JMP is unnecessary, remove it. | There is no JMPE that corresponds to this JMP. |
| JMP/JMPE TO BAD COM LEVEL | JMP and corresponding JMPE must have same COM/COME status. Review JMP range and COM range, to adjust not to overlap with each other: it is possible that one range includes the other completely. | JMP and corresponding JMPE have different COM/COME status. |
| COME IN JMP | COME and corresponding COM must have same JMP/JMPE status. Review COM range and JMP range, to adjust not to overlap with each other: it is possible that one range includes the other completely. | COME is found between JMP and JMPE, and COM and corresponding COME have different JMP/JMPE status. |
| END IN JMP END1 IN JMP END2 IN JMP END3 IN JMP | If JMPE is missing, add it in proper position. If JMP is unnecessary, remove it. | END, END1, END2, or END3 is found between JMP and JMPE. |
| SP/SPE IN JMP | If JMPE is missing, add it in proper position. If the JMP is unnecessary, remove it. | SP or SPE is found between JMP and JMPE. |
| JMPB OVER COM BORDER | JMPB and its destination must have same COM/COME status. Review range of JMPB and COM range, to adjust not to overlap with each other: it is possible that one range includes the other completely. | JMPB and its destination differ in COM/COME status. |
| JMPB OVER LEVEL | JMPB can only jump to the same program level, or within a subprogram. If the JMPB is unnecessary, remove it. If LBL for the JMPB is missing, add it in proper position. If it should be JMPC, correct it. | JMPB jumps to different program level. |
| LBL FOR JMPB NOT FOUND | If JMPB is unnecessary, remove it. If LBL is missing, add it in proper position. | Can not find proper LBL for JMPB. |
| JMPC IN BAD LEVEL | JMPC is used to jump from a subprogram to level 2. If the JMPC is unnecessary, remove it. If it should be JMPB or JMP, correct it. | JMPC is used in other than subprogram. |
| LBL FOR JMPC NOT FOUND | If JMPC is unnecessary, remove it. If LBL is missing, add it in proper position: JMPC jumps into level 2. If it should be JMPB or JMP, correct it. | Can not find proper LBL for JMPC. |

| Alarm number | Faulty location/corrective action | Contents |
|---------------------------------|--|---|
| LBL FOR JMPC IN BAD LEVEL | JMPC is used to jump from a subprogram to level 2. If the JMPC is unnecessary, remove it. If another LBL of same L-address that the JMPC is intended to jump exists in the subprogram, assign different L-address to these two LBLs. If it should be JMPB or JMP, correct it. | Destination of JMPC is not level 2. |
| JMPC INTO COM | LBL for JMPC must be located out of any COM and COME pair. If the JMPC is unnecessary, remove it. If the LBL is located wrong, move it to correct position. If the L-address of JMPC is wrong, correct it. | JMPC jumps to LBL between COM and COME. |
| JMPE WITHOUT JMP | If JMP is missing, add it in proper position. If the JMPE is unnecessary, remove it. | There is no JMP that corresponds to this JMPE. |
| TOO MANY LBL | Remove unnecessary LBLs. If this error still occurs, adjust the construction of program to use less LBLs. | There are too many LBLs. |
| DUPLICATE LBL | If some of these LBLs are unnecessary, remove them. If all of these LBLs is necessary, assign other L-addresses to them to make all LBLs unique. | Same L-address is used in plural LBLs. |
| OVERLAPPED SP | If SP is missing, add it in proper position. If the SPE is unnecessary, remove it. | There is no SP that corresponds to this SPE. |
| SPE WITHOUT SP | If SP is missing, add it in proper position. If the SPE is unnecessary, remove it. | There is no SP that corresponds to this SPE. |
| END IN SP | If SPE is missing, add it in proper position. If END is in wrong place, move it to proper position. | END is found between SP and SPE. |
| DUPLICATE P ADDRESS | If some of these SPs are unnecessary, remove them. If all of these SPs is necessary, assign other P-addresses to them to make all SPs unique. | Same P-address is used in plural SPs. |
| DUPLICATE TMRB NUMBER (WARNING) | If some of them are unnecessary, remove them. If all of them are necessary, assign other number to parameter of them to make them unique. (If two or more instructions with same parameter number will never be active simultaneously at one time, the Ladder program has a possibility to work correctly, however, it is recommended from safety and maintenance points of view, that all these instructions should have different parameter number with each other.) | Plural TMRBs have the same number as their parameter. (This is warning.) |
| ILLEGAL TMRB NUMBER | If unnecessary, remove it. Assign correct number not to exceed the maximum number defined by each PMC model. | TMRB has parameter number that is out of range. |

| Alarm number | Faulty location/corrective action | Contents |
|-----------------------------------|--|--|
| DUPLICATE TMR NUMBER (WARNING) | If some of them are unnecessary, remove them. If all of them are necessary, assign other number to parameter of them to make them unique. (If two or more instructions with same parameter number will never be active simultaneously at one time, the Ladder program has a possibility to work correctly, however, it is recommended from safety and maintenance points of view, that all these instructions should have different parameter number with each other.) | Plural TMRs have the same number as their parameter. (This is warning.) |
| ILLEGAL TMR NUMBER | If unnecessary, remove it. Assign correct number not to exceed the maximum number defined by each PMC model. | TMR has parameter number that is out of range. |
| NO SUCH SUBPROGRAM | If it calls wrong subprogram, correct it. If the subprogram is missing, create it. | Subprogram that is called by CALL/CALLU is not found. |
| UNAVAILABLE INSTRUCTION | Confirm that this ladder program is correct one. If this program is correct one, all these unsupported instructions have to be removed. | Unsupported instruction for this PMC model is found. |
| SP IN BAD LEVEL | SP can be used at top of a subprogram. Correct it so that no SP exists in other place. | SP is found in wrong place. |
| LADDER PROGRAM IS BROKEN | This ladder program must be all cleared once, and remake ladder program. | Ladder program may be broken by some reason. |
| NO WRITE COIL | Add proper write coil. | Write coil is necessary, but is not found. |
| CALL/CALLU IN BAD LEVEL | CALL/CALLU must be used in Level 2 or in subprograms. Do not use any other places. | CALL/CALLU is used in wrong place. |
| SP IN LEVEL3 | If END3 is located wrong, move it to correct position. If the SP is unnecessary, remove it. | SP is found in level 3. |

Messages that may be displayed during net editing on PMC program editor screen

| Alarm number | Faulty location/corrective action | Contents |
|---|---|--|
| TOO MANY FUNCTIONAL INSTRUCTIONS IN ONE NET | Only one functional instruction is allowed to constitute a net. If necessary, divide the net into plural nets. | Too many functional instructions are in one net. |
| TOO LARGE NET | Divide the net into plural nets so that step number in a net may become small. | Net is too large. When a net is converted into the object, the net exceeds 256 steps. |
| NO INPUT FOR OPERATION | Coil without input, or coil connected to output of functional instruction that has no output, causes this error. If coil is not necessary, remove it. If necessary, connect it to meaningful input. | No signal is provided for logical operation. |
| OPERATION AFTER FUNCTION IS FORBIDDEN | Output of functional instruction can not be connected to a contact, nor to conjunction with other signal that will be implemented by logical-or operation. | No logical operation with functional instruction output is permitted, except write coils. |
| WRITE COIL IS EXPECTED | Add proper write coil to the net. | Write coil is expected, but not found. |
| BAD COIL LOCATION | Coil can be located only at rightmost column. Any coil located at other place must be erased once, and place necessary coils in correct place. | Coil is located in bad position. |
| SHORT CIRCUIT | Find contact with terminals connected by short circuit, and correct connections. | Some contacts are connected with short circuit. |
| FUNCTION AFTER DIVERGENCE IS FORBIDDEN | Functional instruction can not be used in output section of net. If necessary, divide the net into plural nets. | Functional instruction is used in output section of net. |
| ALL COIL MUST HAVE SAME INPUT | Left terminals of all coils in a net must be connected to same input point. | When a net contains more than one coil, the coils should not have any contact beside them affects only of the coils. |
| BAD CONDITION INPUT | Check the connection of all condition inputs of the functional instruction. Especially for functional instruction that has more than one condition input, check if connections to condition inputs interfere with each other. | Some condition input of functional instruction is not connected correctly. |
| NO CONNECTION | Find gap that is expected to be connected, and correct the connection. | There is signal connected to nowhere. |
| NET IS TOO COMPLICATED | Examine every connection, and find unnecessarily bending connection, or coils that are connected to different point. | Net is too complicated to analyze. |
| PARAMETER IS NOT SUPPLIED | Enter all of the relay addresses, and parameters of functional instructions. | Relay with blank address, or blank parameter of functional instruction, is found. |

(6) Alarm messages (For EDIT: PMC-SA1)

| Message | Contents and solution |
|-------------------------|---|
| ADDRESS BIT NOTHING | The address of the relay/coil is not set. |
| FUNCTION NOT FOUND | There is no functional instruction of the input number. |
| COM FUNCTION MISSING | The functional instruction COM (SUB29) is not correctly dealt with. Correspondence of COM and COME (SUB29) is incorrect. Or, the number of coil controlled by COM is specified by the model which the number cannot be specified. |
| EDIT BUFFER OVER | There is no empty area of the buffer for the editing. (solution) Please reduce NET under editing. |
| END FUNCTION MISSING | Functional instruction END1,END2,END3 and END do not exist. Or, there are error net in END1,END2,END3,END. Or, order of END1,END2,END3, and END is not correct. |
| ERROR NET FOUND | There is an error net. |
| ILLEGAL FUNCTION NO. | The wrong number of the functional instruction is searched. |
| FUNCTION LINE ILLEGAL | The functional instruction is not correctly connected. |
| HORIZONTAL LINE ILLEGAL | The horizontal line of the net is not connected. |
| ILLEGAL NET CLEARED | Because the power had been turn off while editing LADDER, some net under editing was cleared. |
| ILLEGAL OPERATION | Operation is not correct. The value is not specified and only INPUT key was pushed. The address data is not correctly inputted. Because the space to display the instruction on screen is not enough, the functional instruction cannot be made. |
| SYMBOL UNDEFINED | The symbol which was inputted is not defined. |
| INPUT INVALID | There is an incorrect input data. Non-numerical value was inputted with COPY, INSLIN,C-UP,C-DOWN etc. The input address was specified for write coil. An illegal character was specified for the data table. |
| NET TOO LARGE | The input net is larger than the editing buffer. (solution) Please reduce the net under editing. |
| JUMP FUNCTION MISSING | The functional instruction JMP(SUB10) is not correctly dealt with. Correspondence of JMP and JMPE(SUB30) is incorrect. The number of coil to jump is specified by the model which the number of coil cannot specified. (It is possible to specify the coil number only on PMC-RB/RC.) |
| LADDER BROKEN | LADDER is broken. |
| LADDER ILLEGAL | There is an incorrect LADDER. |
| IMPOSSIBLE WRITE | You try to edit sequence program on the ROM. |
| OBJECT BUFFER OVER | The sequence program area was filled. (solution) Please reduce the LADDER. |
| PARAMETER NOTHING | There is no parameter of the functional instruction. |
| PLEASE COMPLETE NET | The error net was found in LADDER. (solution) After correcting the error net, please continue operating. |

| Message | Contents and solution |
|-----------------------------|---|
| PLEASE KEY IN SUB NO. | Please input the number of the functional instruction. (solution) If you do not input the functional instruction, please push soft key "FUNC" again. |
| PROGRAM MODULE NOTHING | You tried to edit though there was neither RAM for debugging nor ROM for sequence program. |
| RELAY COIL FORBIT | There is an unnecessary relay or coil. |
| RELAY OR COIL NOTHING | The relay or the coil does not suffice. |
| PLEASE CLEAR ALL | It is impossible to recover the sequence program. (solution) Please clear the all data. |
| SYMBOL DATA DUPLICATE | The same symbol name is defined in other place. |
| COMMENT DATA OVERFLOW | The comment data area was filled. (solution) Please reduce the number of the comment. |
| SYMBOL DATA OVERFLOW | The symbol data area was filled. (solution) Please reduce the number of the symbol. |
| VERTICAL LINE ILLEGAL | There is an incorrect vertical line of the net. |
| MESSAGE DATA OVERFLOW | The message data area was filled. (solution) Please reduce the number of the message. |
| 1ST LEVEL EXECUTE TIME OVER | The 1st level of LADDER is too large to complete execution in time. (solution) Please reduce the 1st level of LADDER. |
| PARA NO. RANGE ERR: | The parameter number for a function instruction is not in the range. (solution) Correct the number so that it is within the range. |
| PARA NO. DUPLICATE: | The parameter number for a function instruction is used more than once. (solution) If the duplicate numbers pose the problem of simultaneous operation, change the parameter number to an unused number. |

(7) Error Messages (at Automatic Write to Flash ROM after Ladder Editing)

| Error message | Contents and solution |
|---|--|
| PROGRAM ALREADY EXISTS | A program already exists on flash ROM. (At BLANK) |
| PROGRAM ALREADY EXISTS (EXEC?) | A program already exists on flash ROM. (Remedy) When the message is displayed, pressing the EXEC key again causes write or erasure operation. (At write or erasure) |
| PROGRAM NOTHING | There is no program on flash ROM. |
| ERASE ERROR F-ROM WRITE ERROR 13 F-ROM WRITE ERROR 28 | Flash ROM is abnormal. Replacement is required. Ask FANUC Service Representative for replacement. |
| WRITE ERROR F-ROM WRITE ERROR 12 F-ROM WRITE ERROR 29 | |
| READ ERROR | |
| ANOTHER USED F-ROM WRITE ERROR 9 F-ROM WRITE ERROR 36 | Flash ROM is used by other than PMC. |
| MUST BE IN EMG STOP NOT EMG STOP F-ROM WRITE ERROR 10 F-ROM WRITE ERROR 37 | The CNC is not in the emergency stop state. |
| NO OPTION | There is no ROM cassette option. |
| SIZE ERROR IMPOSSIBLE WRITE (SIZE OVER) NO SPACE F-ROM WRITE ERROR 1 F-ROM WRITE ERROR 15 F-ROM WRITE ERROR 35 | The sequence program is larger than the flash ROM size. (At write) (Remedy) Try the condense function. (EDIT/CLEAR screen) If the same phenomenon is still observed, the flash ROM size must be enlarged. The sequence program to be read is larger than the RAM size. (At read) (Remedy) RAM must be enlarged. |

(8) Error Messages (at Assignment Data Editing)

| Message | Contents and solution |
|-------------------------------------|---|
| ERR: GROUP NO. (0—15) | The group number must be 0 to 15. |
| ERR: BASE NO. (0—1) | The base number must be 0 or 1. |
| WARN: BASE NO. MUST BE 0 | For I/O Unit-B, the base number must be 0. The base number was set to 0 forcibly. |
| ERR: SLOT NO. (1—10) | For I/O Unit-A, the slot number must be 1 to 10. |
| ERR: SLOT NO. (0, 1—30) | For I/O Unit-B, the slot number must be 0 or a number 1 to 30. |
| ERR: SLOT NO. MUST BE 0 | When power on/off information for I/O Unit-B is set, the slot number must be 0. |
| ERR: ILLEGAL NAME | The input assignment name is illegal or not supported. Enter a correct name. |
| INPUT INVALID | The input character string is illegal. Enter a character string in a correct input format again. |
| IMPOSSIBLE WRITE | An attempt was made to edit ROM data. ROM data cannot be edited. |
| ERR: ADDRESS ALREADY ASSIGNED | The specified address is already assigned. Assign another address. Alternatively, delete the existing data, then set the address again. |
| ERR: ADDRESS OVER | A set address exceeds the maximum value (X127, Y127). Check the addresses dedicated to the unit to be set. |
| ERR: SLOT ALREADY DEFINED | The specified slot is already assigned. Check the existing data. |
| WARN: SLOT ALREADY DEFINED | The specified slot is already assigned. Check the existing data. |
| ERR: UNIT TYPE MISMATCH (IN OR OUT) | An output module cannot be allocated to an X address, or an input module cannot be allocated to a Y address. |
| WARN: UNIT TYPE MISMATCH (MODEL) | I/O Unit-A and I/O Unit-B are assigned to the same group. These units cannot exist together within the same group. |

(9) Alarm messages (For I/O)

| | Error message | Contents and solution |
|---|--|---|
| F L A S H R O M | PROGRAM ALREADY EXISTS | A program already exists on flash ROM. (At BLANK) |
| | PROGRAM ALREADY EXISTS (EXEC ?) | A program already exists on flash ROM. Remedy) When the message is displayed, pressing the EXEC key again causes write or erasure operation. (At write or erasure) |
| | PROGRAM NOTHING | There is no program on flash ROM. |
| | ERASE ERROR | Flash ROM is abnormal. Replacement is required. Ask FANUC Service Representative for replacement. |
| | WRITE ERROR | |
| | READ ERROR | |
| | ANOTHER USED | Flash ROM is used by other than PMC. |
| | MUST BE IN EMG STOP NOT EMG STOP | The CNC is not in the emergency stop state. |
| | NO OPTION | There is no ROM cassette option. |
| SIZE ERROR | The sequence program is larger than the flash ROM size. (At write) Remedy) Try the condense function. (EDIT/CLEAR screen) If the same phenomenon is still observed, the flash ROM size must be enlarged. The sequence program to be read is larger than the RAM size. (At read) Remedy) RAM must be enlarged. | |
| H O S T · F D C A S · O T H E R S | I/O OPEN ERROR nn | nn = -1: RS-232C is used by other than PMC. Remedy) Check whether RS-232C is used by other than PMC. On the online setting screen (see Section 8.5.1 in III), check that "NOT USE" is indicated for RS-232C. nn = 6: The RS-232C option is not found. nn = 20: RS-232C connection is incorrect. Remedy) Check whether channel setting, connection, baud rate, and other settings are correct. |
| | I/O WRITE ERROR nn | nn = 20: RS-232C connection is incorrect. Remedy) Check whether channel setting, connection, baud rate, and other settings are correct. nn = 22: Communication cannot be performed correctly. Remedy) Check whether the cable is broken. |
| | I/O READ ERROR nn | nn = 20: RS-232C connection is incorrect. Remedy) Check whether channel setting, connection, baud rate, and other settings are correct. nn = 22: Communication cannot be performed correctly. Remedy) Check whether the cable is broken. |
| | ADDRESS IS OUT OF RANGE (xxxxxx) | Data for other than the PMC debugging RAM area was transferred. xxxxxx: Indicates the transfer address. |
| | DATA ERROR | Illegal data was read. Remedy) Check the cable and setting (speed). When a program in C was being read into the 16i/18i/21i: Remedy) Press soft keys [EDIT], [CLEAR], [CLRLNG], then [EXEC] to clear the C area. |
| | PROGRAM DATA ERROR | An attempt was made to output data, but the data was illegal. Remedy) Check the alarm on the alarm screen. |

| | Error message | Contents and solution |
|--|--|---|
| M E M O R Y C A R D | CREATE ERROR | The specified file name is illegal. Remedy) Specify a file name in the MS-DOS form. (See 7.2 (5)) |
| | NO MORE SPACE or WRITE ERROR | There is not enough free space on the memory card. Remedy) Delete files to create free space. |
| | NOT READY | No memory card is installed. Remedy) Check whether a memory card is installed. |
| | MOUNT ERROR | Unformatted. Remedy) Perform formatting. (See 7.3.4 (a)) |
| | WRITE PROTECT | The memory card is protected. Remedy) Set the protect switch of the memory card to OFF. |
| | BATTERY ALARM | The battery for the memory card is too weak. Remedy) Replace the memory card battery. |
| | FILE NOT FOUND | The specified file number or file name is not found. Remedy) With LIST, check the file name or file number. |
| | DELETE ERROR | The file cannot be deleted. Remedy) Change the file attribute. |
| | PROGRAM ALREADY EXISTS | There are duplicate file names. Remedy) Use another file name. |
| C O M M O N | I/O WRITE ERROR nn I/O READ ERROR nn I/O COMPARE ERROR nn I/O DELETE ERROR nn I/O LIST ERROR nn I/O FORMAT ERROR nn | nn = 30: No memory card is installed. Remedy) Check whether a memory card is installed. nn = 31: The memory card cannot be written to. Remedy) Set the protect switch of the memory card to OFF. Replace the memory card with an S-RAM card. nn = 32: The battery for the memory card is too weak. Remedy) Replace the memory card battery. nn = 102: There is not enough free space on the memory card. Remedy) Delete files to create free space. nn = 135: The memory card is unformatted. nn = 105: The memory card is unformatted. Remedy) Format the memory card. nn = 114: The specified file is not found. Remedy) With LIST, check the file name or file number. nn = 115: The specified file is protected. Remedy) Check the file attribute. |
| | COMPARE ERR XXXXXX=AA : BB CONT? (Y/N) | Data differs between the device and PMC. XXXXXX: Address aa: Data on the PMC bb: Data on the device Remedy) To continue operation, enter Y; otherwise, enter N. Then, press the INPUT key. |
| | DATA ERROR | Illegal data has been read. Remedy) Check the cable and setting (speed). When a program in C was being read into the 16i/18i/21i: Remedy) Press soft keys [EDIT], [CLEAR], [CLRLNG], then [EXEC] to clear the C area. |
| | PROGRAM DATA ERROR | An attempt was made to output data, but the data was illegal. Remedy) Check the alarm on the alarm screen. |

A.3 ALARM LIST (SERIAL SPINDLE)

When a serial spindle alarm occurs, the following number is displayed on the CNC. n is a number corresponding to the spindle on which an alarm occurs. (n = 1: First spindle; n = 2: Second spindle; etc.)

NOTE*1

Note that the meanings of the SPM indications differ depending on which LED, the red or yellow LED, is on. When the red LED is on, the SPM indicates a 2-digit alarm number. When the yellow LED is on, the SPM indicates an error number that designates a sequence problem (for example, when a rotation command is entered with the emergency stop state not released).
→ See Appendix A.4, "Error Codes (Serial Spindle)."

Alarm Numbers and Alarms Displayed on the α Series Spindle Amplifier

| No. | Message | SPM indication(*1) | Faulty location and remedy | Description |
|-------|---------------------------------|--------------------|---|--|
| (750) | SPINDLE SERIAL LINK ERROR | A0 A | 1 Replace the ROM on the SPM control printed circuit board. 2 Replace the SPM control printed circuit board. | The program does not start normally. ROM series error or hardware abnormality on the SPM control printed circuit board |
| (749) | S-SPINDLE LSI ERROR | A1 | Replace the SPM control printed circuit board. | An abnormality was detected in the CPU peripheral circuit of the SPM control circuit. |
| 7n01 | SPN_n_ : MOTOR OVERHEAT | 01 | 1 Check and correct the peripheral temperature and load status. 2 If the cooling fan stops, replace it. | The thermostat embedded in the motor winding operated. The internal temperature of the motor exceeds the specified level. The motor is used in excess of the continuous rating, or the cooling component is abnormal. |
| 7n02 | SPN_n_ : EX SPEED ERROR | 02 | 1 Check and correct the cutting conditions to decrease the load. 2 Correct parameter No. 4082. | The motor speed cannot follow a specified speed. An excessive motor load torque is detected. The acceleration/deceleration time in parameter No. 4082 is insufficient. |
| 7n03 | SPN_n_ : FUSE ON DC LINK BLOWN | 03 | 1 Replace the SPM unit. 2 Check the motor insulation status. 3 Replace the interface cable. | The PSM becomes ready (00 is indicated), but the DC link voltage is too low in the SPM. The fuse in the DC link section in the SPM is blown. (The power device is damaged or the motor is ground-fault.) The JX1A/JX1B connection cable is abnormal. |
| 7n04 | SPN_n_ : INPUT FUSE/POWER FAULT | 04 | Check the state of the input power supply to the PSM. | The PSM found a missing power supply phase. (PSM alarm 5) |

| No. | Message | SPM indication(*1) | Faulty location and remedy | Description |
|------|------------------------------------|--------------------|--|---|
| 7n06 | SPN_n_ : THERMAL SENSOR DISCONNECT | 06 | 1 Check and correct the parameter. 2 Replace the feedback cable. | The temperature sensor of the motor is disconnected. |
| 7n07 | SPN_n_ : OVERSPEED | 07 | Check for a sequence error. (For example, check whether spindle synchronization was specified when the spindle could not be turned.) | The motor speed has exceeded 115% of its rated speed. When the spindle axis was in position control mode, positional deviations were accumulated excessively (SFR and SRV were turned off during spindle synchronization.) |
| 7n09 | SPN_n_ : OVERHEAT MAIN CIRCUIT | 09 | 1 Improve the heat sink cooling status. 2 If the heat sink cooling fan stops, replace the SPM unit. | Abnormal temperature rise of the power transistor radiator |
| 7n11 | SPN_n_ : OVERVOLT POW CIRCUIT | 11 | 1 Check the selected PSM. 2 Check the input power voltage and change in power during motor deceleration. If the voltage exceeds 253 VAC (for the 200-V system) or 530 VAC (for the 400-V system), improve the power supply impedance. | Overvoltage of the DC link section of the PSM was detected. (PSM alarm indication: 7) PSM selection error. (The maximum output specification of the PSM is exceeded.) |
| 7n12 | SPN_n_ : OVERCURRENT POW CIRCUIT | 12 | 1 Check the motor insulation status. 2 Check the spindle parameters. 3 Replace the SPM unit. | The motor output current is abnormally high. A motor-specific parameter does not match the motor model. Poor motor insulation |
| 7n15 | SPN_n_ : SP SWITCH CONTROL ALARM | 15 | 1 Check and correct the ladder sequence. 2 Replace the switching MC. | The switch sequence in spindle switch/output switch operation is abnormal. The switching MC contact status check signal and command do not match. |
| 7n16 | SPN_n_ : RAM FAULT | 16 | Replace the SPM control printed circuit board. | Abnormality in an SPM control circuit component is detected. (RAM for external data is abnormal.) |
| 7n18 | SPN_n_ : SUMCHECK ERROR PGM DATA | 18 | Replace the SPM control printed circuit board. | Abnormality in an SPM control circuit component is detected. (Program ROM data is abnormal.) |
| 7n19 | SPN_n_ : EX OFFSET CURRENT U | 19 | Replace the SPM unit. | Abnormality in an SPM component is detected. (The initial value for the U phase current detection circuit is abnormal.) |
| 7n20 | SPN_n_ : EX OFFSET CURRENT V | 20 | Replace the SPM unit. | Abnormality in an SPM component is detected. (The initial value of the V phase current detection circuit is abnormal.) |
| 7n21 | SPN_n_ : POS SENSOR POLARITY ERROR | 21 | Check and correct the parameters. (No. 4000#0, 4001#4) | The polarity parameter setting of the position sensor is wrong. |

| No. | Message | SPM indication(*1) | Faulty location and remedy | Description |
|------|-----------------------------------|--------------------|--|---|
| 7n24 | SPN_n_ : SERIAL TRANSFER ERROR | 24 | 1 Place the CNC-to-spindle cable away from the power cable. 2 Replace the cable. | The CNC power is turned off (normal power-off or broken cable). An error is detected in communication data transferred to the CNC. |
| 7n26 | SPN_n_ : DISCONNECT C-VELO DETECT | 26 | 1 Replace the cable. 2 Re-adjust the pre-amplifier. | The signal amplitude of the detection signal (connector JY2) on the Cs contour control motor side is abnormal. (Unconnected cable, adjustment error, etc.) |
| 7n27 | SPN_n_ : DISCONNECT POS-CODER | 27 | 1 Replace the cable. 2 Re-adjust the BZ sensor signal. | 1 The spindle position coder (connector JY4) signal is abnormal. 2 The signal amplitude (connector JY2) of the MZ or BZ sensor is abnormal. (Unconnected cable, adjustment error, etc.) |
| 7n28 | SPN_n_ : DISCONNECT C-POS DETECT | 28 | 1 Replace the cable 2 Re-adjust the pre-amplifier. | The position detection signal (connector JY5) for Cs contour control is abnormal. (Unconnected cable, adjustment error, etc.) |
| 7n29 | SPN_n_ : SHORTTIME OVERLOAD | 29 | Check and correct the load status. | Excessive load has been applied continuously for a certain period of time. (This alarm is issued also when the motor shaft has been locked in the excitation state.) |
| 7n30 | SPN_n_ : OVERCURRENT POW CIRCUIT | 30 | Check and correct the power supply voltage. | Overcurrent is detected in PSM main circuit input. (PSM alarm indication: 1) Unbalanced power supply. PSM selection error (The maximum PSM output specification is exceeded.) |
| 7n31 | SPN_n_ : MOTOR LOCK OR V-SIG LOS | 31 | 1 Check and correct the load status. 2 Replace the motor sensor cable (JY2 or JY5). | The motor cannot rotate at a specified speed. (A level not exceeding the SST level for the rotation command has existed continuously.) Abnormality in the speed detection signal. |
| 7n32 | SPN_n_ : RAM FAULT SERIAL LSI | 32 | Replace the SPM control printed circuit board. | Abnormality in an SPM control circuit component is detected. (The LSI device for serial transfer is abnormal.) |
| 7n33 | SPN_n_ : SHORTAGE POWER CHARGE | 33 | 1 Check and correct the power supply voltage. 2 Replace the PSM unit. | Charging of direct current power supply voltage in the power circuit section is insufficient when the magnetic contractor in the amplifier is turned on (such as open phase and defective charging resistor). |

| No. | Message | SPM indication(*1) | Faulty location and remedy | Description |
|------|---------------------------------------|--------------------|---|--|
| 7n34 | SPN_n_ : PARAMETER SETTING ERROR | 34 | Correct a parameter value according to the manual. If the parameter number is unknown, connect the spindle check board, and check the indicated parameter. | Parameter data exceeding the allowable limit is set. |
| 7n35 | SPN_n_ : EX SETTING GEAR RATIO | 35 | Correct the value according to the parameter manual. | Gear ratio data exceeding the allowable limit is set. |
| 7n36 | SPN_n_ : OVERFLOW ERROR COUNTER | 36 | Check whether the position gain value is too large, and correct the value. | An error counter overflow occurred. |
| 7n37 | SPN_n_ : SPEED DETECT PAR. ERROR | 37 | Correct the value according to the parameter manual. | The setting of the parameter for the number of pulses in the speed detector is incorrect. |
| 7n39 | SPN_n_ : 1-ROT Cs SIGNAL ERROR | 39 | 1 Adjust the 1-rotation signal in the pre-amplifier. 2 Check the cable shield status. 3 Replace the cable. | An incorrect relationship between the 1-rotation signal and the number of AB phase pulses was detected during Cs contour control. |
| 7n40 | SPN_n_ : NO 1-ROT Cs SIGNAL DETECT | 40 | 1 Adjust the 1-rotation signal in the pre-amplifier. 2 Check the cable shield status. 3 Replace the cable. | The 1-rotation signal is not generated during Cs contour control. |
| 7n41 | SPN_n_ : 1-ROT POS-CODER ERROR | 41 | 1 Check and correct the parameter. 2 Replace the cable. 3 Re-adjust the BZ sensor signal. | 1 The 1-rotation signal of the spindle position coder (connector JY4) is abnormal. 2 The 1-rotation signal (connector JY2) of the MZ or BZ sensor is abnormal. 3 Parameter setting error |
| 7n42 | SPN_n_ : NO 1-ROT. POS-CODER DETECT | 42 | 1 Replace the cable. 2 Re-adjust the BZ sensor signal. | 1 The 1-rotation signal of the spindle position coder (connector JY4) is disconnected. 2 The 1-rotation signal (connector JY2) of the MZ or BZ sensor is disconnected. |
| 7n43 | SPN_n_ : DISCON. PC FOR DIF. SP. MODE | 43 | Replace the cable. | The differential speed position coder signal (connector JY8) in SPM type 3 is abnormal. |
| 7n44 | SPN_n_ : CONTROL CIRCUIT(AD) ERROR | 44 | Replace the SPM control printed circuit board. | Abnormality in an SPM control circuit component was detected (A/D converter abnormality). |
| 7n46 | SPN_n_ : SCREW 1-ROT POS-COD. ALARM | 46 | 1 Check and correct the parameter. 2 Replace the cable. 3 Re-adjust the BZ sensor signal. | An abnormality equivalent to alarm 41 was detected during thread cutting operation. |

| No. | Message | SPM indication(*1) | Faulty location and remedy | Description |
|------|------------------------------------|--------------------|--|---|
| 7n47 | SPN_n_ : POS-CODER SIGNAL ABNORMAL | 47 | <ol style="list-style-type: none"> 1 Replace the cable. 2 Re-adjust the BZ sensor signal. 3 Correct the cable layout (vicinity of the power line). | <ol style="list-style-type: none"> 1 The A/B phase signal of the spindle position coder (connector JY4) is abnormal. 2 The A/B phase signal (connector JY2) of the MZ or BZ sensor is abnormal. <p>The relationship between the A/B phase and 1-rotation signal is incorrect (Pulse interval mismatch).</p> |
| 7n49 | SPN_n_ : HIGH CONV. DIF. SPEED | 49 | Check whether the calculated differential speed value exceeds the maximum motor speed. | In differential speed mode, the speed of the other spindle converted to the speed of the local spindle has exceeded the allowable limit (the differential speed is calculated by multiplying the speed of the other spindle by the gear ratio). |
| 7n50 | SPN_n_ : SPNDL CONTROL OVERSPEED | 50 | Check whether the calculated value exceeds the maximum motor speed. | In spindle synchronization, the speed command calculation value exceeded the allowable limit (the motor speed is calculated by multiplying the specified spindle speed by the gear ratio). |
| 7n51 | SPN_n_ : LOW VOLT DC LINK | 51 | <ol style="list-style-type: none"> 1 Check and correct the power supply voltage. 2 Replace the MC. | Input voltage drop was detected. (PSM alarm indication: 4) (Momentary power failure or poor MC contact) |
| 7n52 | SPN_n_ : ITP SIGNAL ABNORMAL I | 52 | <ol style="list-style-type: none"> 1 Replace the SPM control printed circuit board. 2 Replace the spindle interface printed circuit board in the CNC. | NC interface abnormality was detected (the ITP signal stopped). |
| 7n53 | SPN_n_ : ITP SIGNAL ABNORMAL II | 53 | <ol style="list-style-type: none"> 1 Replace the SPM control printed circuit board. 2 Replace the spindle interface printed circuit board in the CNC. | NC interface abnormality was detected (the ITP signal stopped). |
| 7n54 | SPN_n_ : OVERLOAD CURRENT | 54 | Review the load state. | An overload current was detected. |
| 7n55 | SPN_n_ : POWER LINE SWITCH ERROR | 55 | <ol style="list-style-type: none"> 1 Replace the magnetic contactor. 2 Check and correct the sequence. | The power line state signal of the magnetic contactor for selecting a spindle or output is abnormal. |
| 7n56 | SPN_n_ : INNER COOLING FAN STOP | 56 | Replace the SPM unit. | The cooling fan in the SPM control circuit stopped. |
| 7n57 | SPN_n_ : EX DECELERATION POWER | 57 | <ol style="list-style-type: none"> 1 Decrease the acceleration/deceleration duty. 2 Check the cooling condition (peripheral temperature). 3 If the cooling fan stops, replace the resistor. 4 If the resistance is abnormal, replace the resistor. | <p>An overload was detected in the regenerative resistance. (PSMR alarm indication: 8)</p> <p>Thermostat operation or short-time overload was detected.</p> <p>The regenerative resistor was disconnected, or an abnormal resistance was detected.</p> |

| No. | Message | SPM indication(*1) | Faulty location and remedy | Description |
|------|--------------------------------------|--------------------|--|--|
| 7n58 | SPN_n_ : OVERLOAD IN PSM | 58 | 1 Check the PSM cooling status. 2 Replace the PSM unit. | The temperature of the radiator of the PSM has increased abnormally. (PSM alarm indication: 3) |
| 7n59 | SPN_n_ : COOLING FAN STOP IN PSM | 59 | Replace the SPM unit. | The cooling fan in the PSM stopped. (PSM alarm indication: 2) |
| 7n62 | SPN_n_ : MOTOR VCMD OVERFLOWED | 62 | Check and correct the parameters. (No. 4021, 4056 to 4059) | The specified motor speed is too large. |
| 7n66 | SPN_n_ : AMP MODULE COMMUNICATION | 66 | 1 Replace the cable. 2 Check and correct the connection. | An error was found in communication between amplifiers. |
| 7n73 | SPN_n_ : MOTOR SENSOR DISCONNECTED | 73 | 1 Replace the feedback cable. 2 Check the shield processing. 3 Check and correct the connection. 4 Adjust the sensor. | The motor sensor feedback signal is not present. |
| 7n74 | SPN_n_ : CPU TEST ERROR | 74 | Replace the SPM control printed-circuit board. | An error was detected in a CPU test. |
| 7n75 | SPN_n_ : CRC ERROR | 75 | Replace the SPM control printed-circuit board. | An error was detected in a CRC test. |
| 7n79 | SPN_n_ : INITIAL TEST ERROR | 79 | Replace the SPM control printed-circuit board. | An error was detected in an initial test operation. |
| 7n81 | SPN_n_ : 1-ROT MOTOR SENSOR ERROR | 81 | 1 Check and correct the parameter. 2 Replace the feedback cable. 3 Adjust the sensor. | The one-rotation signal of the motor sensor cannot be correctly detected. |
| 7n82 | SPN_n_ : NO 1-ROT MOTOR SENSOR | 82 | 1 Replace the feedback cable. 2 Adjust the sensor. | The one-rotation signal of the motor sensor is not generated. |
| 7n83 | SPN_n_ : MOTOR SENSOR SIGNAL ERROR | 83 | 1 Replace the feedback cable. 2 Adjust the sensor. | An irregularity was detected in a motor sensor feedback signal. |
| 7n84 | SPN_n_ : SPNDL SENSOR DISCONNECTED | 84 | 1 Replace the feedback cable. 2 Check the shield processing. 3 Check and correct the connection. 4 Check and correct the parameter. 5 Adjust the sensor. | The spindle sensor feedback signal is not present. |
| 7n85 | SPN_n_ : 1-ROT SPNDL SENSOR ERROR | 85 | 1 Check and correct the parameter. 2 Replace the feedback cable. 3 Adjust the sensor. | The one-rotation signal of the spindle sensor cannot be correctly detected. |
| 7n86 | SPN_n_ : NO 1-ROT SPNDL SENSOR ERROR | 86 | 1 Replace the feedback cable. 2 Adjust the sensor. | The one-rotation signal of the spindle sensor is not generated. |
| 7n87 | SPN_n_ : SPNDL SENSOR SIGNAL ERROR | 87 | The one-rotation signal of the spindle sensor is not generated. | An irregularity was detected in a spindle sensor feedback signal. |

| No. | Message | SPM indication(*1) | Faulty location and remedy | Description |
|------|----------------------------------|--------------------|---------------------------------------|------------------------------------|
| 7n88 | SPN_n_ : COOLING RADIFAN FAILURE | 88 | Replace the SPM external cooling fan. | The external cooling fan stopped. |
| 7n97 | SPN_n_ : OTHER SPINDLE ALARM | 97 | Replace the SPM. | Another irregularity was detected. |
| 7n98 | SPN_n_ : OTHER CONVERTER ALARM | 98 | Check the PSM alarm display. | A PSM alarm was detected. |

| No. | Message | SPM indication(*1) | Faulty location and remedy | Description |
|------|------------------------------------|--------------------|--|--|
| 9001 | SPN_n_ : MOTOR OVERHEAT | 01 | 1 Check and correct the peripheral temperature and load status. 2 If the cooling fan stops, replace it. | The thermostat embedded in the motor winding operated. The internal temperature of the motor exceeds the specified level. The motor is used in excess of the continuous rating, or the cooling component is abnormal. |
| 9002 | SPN_n_ : EX SPEED ERROR | 02 | 1 Check and correct the cutting conditions to decrease the load. 2 Correct parameter No. 4082. | The motor speed cannot follow a specified speed. An excessive motor load torque is detected. The acceleration/deceleration time in parameter No. 4082 is insufficient. |
| 9003 | SPN_n_ : FUSE ON DC LINK BLOWN | 03 | 1 Replace the SPM unit. 2 Check the motor insulation status. 3 Replace the interface cable. | The PSM becomes ready (00 is indicated), but the DC link voltage is too low in the SPM. The fuse in the DC link section in the SPM is blown. (The power device is damaged or the motor is ground-fault.) The JX1A/JX1B connection cable is abnormal. |
| 9006 | SPN_n_ : THERMAL SENSOR DISCONNECT | 06 | 1 Check and correct the parameter. 2 Replace the feedback cable. | The temperature sensor of the motor is disconnected. |
| 9007 | SPN_n_ : OVERSPEED | 07 | Check for a sequence error. (For example, check whether spindle synchronization was specified when the spindle could not be turned.) | The motor speed has exceeded 115% of its rated speed. When the spindle axis was in position control mode, positional deviations were accumulated excessively (SFR and SRV were turned off during spindle synchronization.) |
| 9009 | SPN_n_ : OVERHEAT MAIN CIRCUIT | 09 | 1 Improve the heat sink cooling status. 2 If the heat sink cooling fan stops, replace the SPM unit. | Abnormal temperature rise of the power transistor radiator |

| No. | Message | SPM indication(*1) | Faulty location and remedy | Description |
|------|------------------------------------|--------------------|--|---|
| 9011 | SPN_n_ : OVERVOLT POW CIRCUIT | 11 | <ol style="list-style-type: none"> 1 Check the selected PSM. 2 Check the input power voltage and change in power during motor deceleration. If the voltage exceeds 253 VAC (for the 200-V system) or 530 VAC (for the 400-V system), improve the power supply impedance. | <p>Overvoltage of the DC link section of the PSM was detected. (PSM alarm indication: 7)</p> <p>PSM selection error. (The maximum output specification of the PSM is exceeded.)</p> |
| 9012 | SPN_n_ : OVERCURRENT POW CIRCUIT | 12 | <ol style="list-style-type: none"> 1 Check the motor insulation status. 2 Check the spindle parameters. 3 Replace the SPM unit. | <p>The motor output current is abnormally high.</p> <p>A motor-specific parameter does not match the motor model.</p> <p>Poor motor insulation</p> |
| 9015 | SPN_n_ : SP SWITCH CONTROL ALARM | 15 | <ol style="list-style-type: none"> 1 Check and correct the ladder sequence. 2 Replace the switching MC. | <p>The switch sequence in spindle switch/output switch operation is abnormal.</p> <p>The switching MC contact status check signal and command do not match.</p> |
| 9016 | SPN_n_ : RAM FAULT | 16 | Replace the SPM control printed circuit board. | Abnormality in an SPM control circuit component is detected. (RAM for external data is abnormal.) |
| 9018 | SPN_n_ : SUMCHECK ERROR PGM DATA | 18 | Replace the SPM control printed circuit board. | Abnormality in an SPM control circuit component is detected. (Program ROM data is abnormal.) |
| 9019 | SPN_n_ : EX OFFSET CURRENT U | 19 | Replace the SPM unit. | Abnormality in an SPM component is detected. (The initial value for the U phase current detection circuit is abnormal.) |
| 9020 | SPN_n_ : EX OFFSET CURRENT V | 20 | Replace the SPM unit. | Abnormality in an SPM component is detected. (The initial value of the V phase current detection circuit is abnormal.) |
| 9021 | SPN_n_ : POS SENSOR POLARITY ERROR | 21 | Check and correct the parameters. (No. 4000#0, 4001#4) | The polarity parameter setting of the position sensor is wrong. |
| 9024 | SPN_n_ : SERIAL TRANSFER ERROR | 24 | <ol style="list-style-type: none"> 1 Place the CNC-to-spindle cable away from the power cable. 2 Replace the cable. | <p>The CNC power is turned off (normal power-off or broken cable).</p> <p>An error is detected in communication data transferred to the CNC.</p> |
| 9027 | SPN_n_ : DISCONNECT POS-CODER | 27 | <ol style="list-style-type: none"> 1 Replace the cable. 2 Re-adjust the BZ sensor signal. | <ol style="list-style-type: none"> 1 The spindle position coder (connector JY4) signal is abnormal. 2 The signal amplitude (connector JY2) of the MZ or BZ sensor is abnormal. <p>(Unconnected cable, adjustment error, etc.)</p> |

| No. | Message | SPM indication(*1) | Faulty location and remedy | Description |
|------|----------------------------------|--------------------|---|---|
| 9029 | SPN_n_ : SHORTTIME OVERLOAD | 29 | Check and correct the load status. | Excessive load has been applied continuously for a certain period of time. (This alarm is issued also when the motor shaft has been locked in the excitation state.) |
| 9030 | SPN_n_ : OVERCURRENT POW CIRCUIT | 30 | Check and correct the power supply voltage. | Overcurrent is detected in PSM main circuit input. (PSM alarm indication: 1) Unbalanced power supply. PSM selection error (The maximum PSM output specification is exceeded.) |
| 9031 | SPN_n_ : MOTOR LOCK OR V-SIG LOS | 31 | 1 Check and correct the load status. 2 Replace the motor sensor cable (JY2 or JY5). | The motor cannot rotate at a specified speed. (A level not exceeding the SST level for the rotation command has existed continuously.) Abnormality in the speed detection signal. |
| 9032 | SPN_n_ : RAM FAULT SERIAL LSI | 32 | Replace the SPM control printed circuit board. | Abnormality in an SPM control circuit component is detected. (The LSI device for serial transfer is abnormal.) |
| 9033 | SPN_n_ : SHORTAGE POWER CHARGE | 33 | 1 Check and correct the power supply voltage. 2 Replace the PSM unit. | Charging of direct current power supply voltage in the power circuit section is insufficient when the magnetic contractor in the amplifier is turned on (such as open phase and defective charging resistor). |
| 9034 | SPN_n_ : PARAMETER SETTING ERROR | 34 | Correct a parameter value according to the manual. If the parameter number is unknown, connect the spindle check board, and check the indicated parameter. | Parameter data exceeding the allowable limit is set. |
| 9035 | SPN_n_ : EX SETTING GEAR RATIO | 35 | Correct the value according to the parameter manual. | Gear ratio data exceeding the allowable limit is set. |
| 9036 | SPN_n_ : OVERFLOW ERROR COUNTER | 36 | Check whether the position gain value is too large, and correct the value. | An error counter overflow occurred. |
| 9037 | SPN_n_ : SPEED DETECT PAR. ERROR | 37 | Correct the value according to the parameter manual. | The setting of the parameter for the number of pulses in the speed detector is incorrect. |
| 9041 | SPN_n_ : 1-ROT POS-CODER ERROR | 41 | 1 Check and correct the parameter. 2 Replace the cable. 3 Re-adjust the BZ sensor signal. | 1 The 1-rotation signal of the spindle position coder (connector JY4) is abnormal. 2 The 1-rotation signal (connector JY2) of the MZ or BZ sensor is abnormal. 3 Parameter setting error |

| No. | Message | SPM indication(*1) | Faulty location and remedy | Description |
|------|---------------------------------------|--------------------|---|---|
| 9042 | SPN_n_ : NO 1-ROT. POS-CODER DETECT | 42 | 1 Replace the cable. 2 Re-adjust the BZ sensor signal. | 1 The 1-rotation signal of the spindle position coder (connector JY4) is disconnected. 2 The 1-rotation signal (connector JY2) of the MZ or BZ sensor is disconnected. |
| 9043 | SPN_n_ : DISCON. PC FOR DIF. SP. MODE | 43 | Replace the cable. | The differential speed position coder signal (connector JY8) in SPM type 3 is abnormal. |
| 9046 | SPN_n_ : SCREW 1-ROT POS-COD. ALARM | 46 | 1 Check and correct the parameter. 2 Replace the cable. 3 Re-adjust the BZ sensor signal. | An abnormality equivalent to alarm 41 was detected during thread cutting operation. |
| 9047 | SPN_n_ : POS-CODER SIGNAL ABNORMAL | 47 | 1 Replace the cable. 2 Re-adjust the BZ sensor signal. 3 Correct the cable layout (vicinity of the power line). | 1 The A/B phase signal of the spindle position coder (connector JY4) is abnormal. 2 The A/B phase signal (connector JY2) of the MZ or BZ sensor is abnormal. The relationship between the A/B phase and 1-rotation signal is incorrect (Pulse interval mismatch). |
| 9049 | SPN_n_ : HIGH CONV. DIF. SPEED | 49 | Check whether the calculated differential speed value exceeds the maximum motor speed. | In differential speed mode, the speed of the other spindle converted to the speed of the local spindle has exceeded the allowable limit (the differential speed is calculated by multiplying the speed of the other spindle by the gear ratio). |
| 9050 | SPN_n_ : SPNDL CONTROL OVERSPEED | 50 | Check whether the calculated value exceeds the maximum motor speed. | In spindle synchronization, the speed command calculation value exceeded the allowable limit (the motor speed is calculated by multiplying the specified spindle speed by the gear ratio). |
| 9051 | SPN_n_ : LOW VOLT DC LINK | 51 | 1 Check and correct the power supply voltage. 2 Replace the MC. | Input voltage drop was detected. (PSM alarm indication: 4) (Momentary power failure or poor MC contact) |
| 9052 | SPN_n_ : ITP SIGNAL ABNORMAL I | 52 | 1 Replace the SPM control printed circuit board. 2 Replace the spindle interface printed circuit board in the CNC. | NC interface abnormality was detected (the ITP signal stopped). |
| 9053 | SPN_n_ : ITP SIGNAL ABNORMAL II | 53 | 1 Replace the SPM control printed circuit board. 2 Replace the spindle interface printed circuit board in the CNC. | NC interface abnormality was detected (the ITP signal stopped). |
| 9054 | SPN_n_ : OVERLOAD CURRENT | 54 | Review the load state. | An overload current was detected. |
| 9055 | SPN_n_ : POWER LINE SWITCH ERROR | 55 | 1 Replace the magnetic contactor. 2 Check and correct the sequence. | The power line state signal of the magnetic contactor for selecting a spindle or output is abnormal. |

| No. | Message | SPM indication(*1) | Faulty location and remedy | Description |
|------|------------------------------------|--------------------|--|--|
| 9056 | SPN_n_ : INNER COOLING FAN STOP | 56 | Replace the SPM unit. | The cooling fan in the SPM control circuit stopped. |
| 9057 | SPN_n_ : EX DECELERATION POWER | 57 | <ol style="list-style-type: none"> 1 Decrease the acceleration/deceleration duty. 2 Check the cooling condition (peripheral temperature). 3 If the cooling fan stops, replace the resistor. 4 If the resistance is abnormal, replace the resistor. | <p>An overload was detected in the regenerative resistance. (PSMR alarm indication: 8)</p> <p>Thermostat operation or short-time overload was detected.</p> <p>The regenerative resistor was disconnected, or an abnormal resistance was detected.</p> |
| 9058 | SPN_n_ : OVERLOAD IN PSM | 58 | <ol style="list-style-type: none"> 1 Check the PSM cooling status. 2 Replace the PSM unit. | The temperature of the radiator of the PSM has increased abnormally. (PSM alarm indication: 3) |
| 9059 | SPN_n_ : COOLING FAN STOP IN PSM | 59 | Replace the SPM unit. | The cooling fan in the PSM stopped. (PSM alarm indication: 2) |
| 9066 | SPN_n_ : AMP MODULE COMMUNICATION | 66 | <ol style="list-style-type: none"> 1 Replace the cable. 2 Check and correct the connection. | An error was found in communication between amplifiers. |
| 9073 | SPN_n_ : MOTOR SENSOR DISCONNECTED | 73 | <ol style="list-style-type: none"> 1 Replace the feedback cable. 2 Check the shield processing. 3 Check and correct the connection. 4 Adjust the sensor. | The motor sensor feedback signal is not present. |
| 9074 | SPN_n_ : CPU TEST ERROR | 74 | Replace the SPM control printed-circuit board. | An error was detected in a CPU test. |
| 9075 | SPN_n_ : CRC ERROR | 75 | Replace the SPM control printed-circuit board. | An error was detected in a CRC test. |
| 9079 | SPN_n_ : INITIAL TEST ERROR | 79 | Replace the SPM control printed-circuit board. | An error was detected in an initial test operation. |
| 9081 | SPN_n_ : 1-ROT MOTOR SENSOR ERROR | 81 | <ol style="list-style-type: none"> 1 Check and correct the parameter. 2 Replace the feedback cable. 3 Adjust the sensor. | The one-rotation signal of the motor sensor cannot be correctly detected. |
| 9082 | SPN_n_ : NO 1-ROT MOTOR SENSOR | 82 | <ol style="list-style-type: none"> 1 Replace the feedback cable. 2 Adjust the sensor. | The one-rotation signal of the motor sensor is not generated. |
| 9083 | SPN_n_ : MOTOR SENSOR SIGNAL ERROR | 83 | <ol style="list-style-type: none"> 1 Replace the feedback cable. 2 Adjust the sensor. | An irregularity was detected in a motor sensor feedback signal. |
| 9084 | SPN_n_ : SPNDL SENSOR DISCONNECTED | 84 | <ol style="list-style-type: none"> 1 Replace the feedback cable. 2 Check the shield processing. 3 Check and correct the connection. 4 Check and correct the parameter. 5 Adjust the sensor. | The spindle sensor feedback signal is not present. |
| 9085 | SPN_n_ : 1-ROT SPNDL SENSOR ERROR | 85 | <ol style="list-style-type: none"> 1 Check and correct the parameter. 2 Replace the feedback cable. 3 Adjust the sensor. | The one-rotation signal of the spindle sensor cannot be correctly detected. |

| No. | Message | SPM indication(*1) | Faulty location and remedy | Description |
|------|--------------------------------------|--------------------|---|---|
| 9086 | SPN_n_ : NO 1-ROT SPNDL SENSOR ERROR | 86 | 1 Replace the feedback cable. 2 Adjust the sensor. | The one-rotation signal of the spindle sensor cannot be correctly detected. |
| 9087 | SPN_n_ : SPNDL SENSOR SIGNAL ERROR | 87 | The one-rotation signal of the spindle sensor is not generated. | An irregularity was detected in a spindle sensor feedback signal. |
| 9088 | SPN_n_ : COOLING RADIFAN FAILURE | 88 | Replace the SPM external cooling fan. | The external cooling fan stopped. |
| 9097 | SPN_n_ : OTHER SPINDLE ALARM | | Check the SPM alarm display. | Other spindle alarm |
| 9098 | SPN_n_ : OTHER CONVERTER ALARM | | Check the PSM alarm display. | Other converter alarm |
| 9110 | SPN_n_ : AMP COMMUNICATION ERROR | b0 | 1 Replace the communication cable between amplifier and module. 2 Replace the SPM or PSM control printed circuit board. | Communication error between amplifier and module |
| 9111 | SPN_n_ : CONV.LOW VOLT CONTROL | b1 | Replace the PSM control printed circuit board. | Low converter control power supply voltage (PSM indication = 6) |
| 9112 | SPN_n_ : CONV.EXDISCHARGE POW. | b2 | 1 Check the regenerative resistance. 2 Check the motor selection. 3 Replace the PSM | Excessive converter regenerative power (PSM indication = 8) |
| 9113 | SPN_n_ : CONV.COOLING FAN FAILURE | b3 | Replace the cooling fan. | Stopped cooling fan of the converter radiator (PSM indication = A) |
| 9120 | SPN_n_ : COMMUNICATION DATA ERROR | C0 | 1 Replace the communication cable between CNC and SPM. 2 Replace the SPM control printed circuit board. 3 Replace the CNC side spindle interface printed circuit board. | Communication data alarm |
| 9121 | SPN_n_ : COMMUNICATION DATA ERROR | C1 | 1 Replace the communication cable between CNC and SPM. 2 Replace the SPM control printed circuit board. 3 Replace the CNC side spindle interface printed circuit board. | Communication data alarm |
| 9122 | SPN_n_ : COMMUNICATION DATA ERROR | C2 | 1 Replace the communication cable between CNC and SPM. 2 Replace the SPM control printed circuit board. 3 Replace the CNC side spindle interface printed circuit board. | Communication data alarm |

A.4 ERROR CODES (SERIAL SPINDLE)

NOTE*1

Note that the meanings of the SPM indications differ depending on which LED, the red or yellow LED, is on. When the yellow LED is on, an error code is indicated with a 2-digit number. The error code is not displayed on the CNC screen.

When the red LED is on, the SPM indicates the number of an alarm generated in the serial spindle.

→ See Appendix A.3, "Alarms (Serial Spindle)."

Errors Displayed on the α Series Spindle Amplifier

| SPM indication(*1) | Faulty location and remedy | Description |
|--------------------|---|---|
| 00 | Check the *ESP and MRDY sequence. (For MRDY, pay attention to the parameter setting regarding the use of the MRDY signal (bit 0 of parameter No. 4001).) | Although neither *ESP (emergency stop signal; there are two types of signals including the PMC signal and PSM contact signal(*2)) nor MRDY (machine ready signal) is input, SFR (forward rotation signal)/SRF (reverse rotation signal)/ORCM (orientation command) is input. |
| 01 | Check the spindle motor speed detector parameter (bits 2, 1, and 0 of parameter No. 4011). | When the spindle motor has a high-resolution magnetic pulse coder (Cs sensor) (bits 6 and 5 of parameter No. 4001 are set to 0 and 1, respectively), 128 /rev is to be set for the speed detector (bits 2, 1, and 0 of parameter No. 4011 are set to 0, 0, and 1, respectively). However, a value other than 128 /rev is set. In this case, the motor is not excited. |
| 02 | Check the parameters for the detector for Cs contour control (bit 5 of parameter No. 4001 and bit 4 of parameter No. 4018). | Although use of a high-resolution magnetic pulse coder (bit 5 of parameter No. 4001 = 1) or use of the Cs contour control function by the sensor (bit 4 of parameter No. 4018 = 1) is not set, a Cs control command is input. In this case, the motor is not excited. |
| 03 | Check the position coder signal parameter (bit 2 of parameter No. 4001). | Although use of the position coder signal (bit 2 of parameter No. 4001 = 1) is not set, a servo mode (rigid tapping, spindle positioning) or spindle synchronization command is input. In this case, the motor is not excited. |
| 04 | Check the orientation software option. | Although the orientation option is not set, an orientation command (ORCM) is input. |
| 05 | Check the spindle output switching software option and power line status signal (RCH). | Although the output switching option is not set, the low-speed winding is selected (RCH = 1). |
| 06 | Check the sequence (CON, SFR, SRV). | Although the Cs contour control mode is specified, SFR/SRV is not input. |
| 07 | Check the sequence (SFR, SRV). | Although the servo mode (rigid tapping, spindle positioning) is specified, SFR/SRV is not input. |
| 09 | Check the sequence (SPSYC, SFR, SRV) | Although spindle synchronization mode is specified, SFR/SRV is not input. |
| 10 | During execution of the C-axis control command, do not specify another operation mode. Before entering another mode, cancel the Cs contour control command. | Although Cs contour control mode is set, another operation mode (servo mode, spindle synchronization, or orientation) is specified. |
| 11 | During execution of the servo mode command, do not specify another operation mode. Before entering another mode, cancel the servo mode. | Although servo mode (rigid tapping, or spindle positioning) is set, another operation mode (Cs contour control, spindle synchronization, or orientation) is specified. |

| SPM indication(*1) | Faulty location and remedy | Description |
|--------------------|---|---|
| 12 | During execution of the spindle synchronization command, do not specify another operation mode. Before entering another mode, cancel the spindle synchronization command. | Although spindle synchronization is being performed, another operation mode (Cs contour control, servo mode, or orientation) is specified. |
| 13 | During execution of the orientation command, do not specify another operation mode. Before entering another mode, cancel the orientation command. | Although the orientation command is being executed, another operation mode (Cs contour control, servo mode, or synchronization) is specified. |
| 14 | Input the SFT or SRV signal. | The SFT and SRV signals are both input at the same time. |
| 15 | Check bit 5 of parameter No. 4000 and PMC signal (CON). | When bit 5 of parameter No. 4000 is set to 1 to indicate the presence of the differential speed mode function, Cs contour control is specified. |
| 16 | Check bit 5 of parameter No. 4000 and PMC signal (DEFMD). | When bit 5 of parameter No. 4000 is set to 0 to indicate the absence of the differential speed mode function, the differential speed mode command (DEFMD) is input. |
| 17 | Check bits 2, 1, and 0 of parameter No. 4011. | Setting of the speed detector parameter (bits 2, 1, and 0 of parameter No. 4011) is invalid. (The corresponding speed detector is not present.) |
| 18 | Check bit 2 of parameter No. 4001 and PMC signal (ORCM). | Although bits 2 of parameter No. 4001 is set to 0 not to use the position coder signal, a command for orientation by a position coder (ORCMA) is input. |
| 19 | During execution of the orientation command, do not specify another operation mode. Before entering another mode, cancel the orientation command. | Although orientation by a magnetic sensor is being performed, another operation mode is specified. |
| 20 | Check bit 5 of parameter No. 4001, bit 5 of parameter No. 4014, and bit 4 of parameter No. 4018. | When the use of the slave operation mode function is set (bit 5 of parameter No. 4014 = 1), the use of a high-resolution magnetic pulse coder (bit 5 of parameter No. 4001 = 1) or the use of the Cs contour control function by the sensor (bit 4 of parameter No. 4018 = 1) is specified. These items cannot be set at the same time. |
| 21 | Input the slave operation mode command (SLV) in normal operation mode. | Although position control (such as servo mode or orientation) is being performed, a slave operation mode command (SLV) is input. |
| 22 | Input the position control command in normal operation mode | Although slave operation mode is set (SLVS = 1), a position control command (such as servo mode or orientation) is input. |
| 23 | Check bit 5 of parameter No. 4014 and PMC signal (SLV). | Although bit 5 of parameter No. 4014 is set to 0 not to use the slave operation mode function, a slave operation mode command (SLV) is input. |
| 24 | Check the PMC signal (INCMD). Perform orientation by specifying an absolute position first. | Orientation is performed in incremental operation mode (INCMD = 1) first, then the absolute position command (INCMD = 0) is input. |
| 25 | Check the spindle amplifier specifications and parameter setting (bit 4 of parameter No. 4018). | Although the spindle amplifier SPM type 4 is not used, the use of the Cs contour control function by the sensor is set (bit 4 of parameter No. 4018 = 1). |

NOTE*2

PSM contact signal

Between ESP1 and ESP2 on the PSM

Contact open: Emergency stop

Contact closed: Normal operation

B LIST OF MAINTENANCE PARTS

| Item | | Ordering information | Remarks |
|-----------|---|----------------------|--------------|
| Fuse | Control unit | A02B-0236-K100 | |
| | Separate detector interface unit | A60L-0001-0290#LM20 | Rated at 2 A |
| | I/O module for operator's panel I/O unit for <i>0i</i> For reader/puncher interface of CNC control unit | A03B-0815-K001 | |
| | Connector panel I/O module | A03B-0815-K002 | |
| | Distributed I/O machine operator's panel | A60L-0001-0290#LM10 | |
| Battery | For control unit memory backup | A02B-0200-K102 | (Note 1) |
| | | A02B-0309-K102 | (Note 2) |
| Backlight | For 7.2" LCD | A02B-0309-K112 | |
| | For 8.4" LCD | A02B-0236-K119 | |
| | For 10.4" LCD | A02B-0309-K116 | |

NOTE

1. If the drawing number of the basic unit is A02B-0309-B50n, A02B-0311-B50n, or A02B-0311-B51n (where n is 0, 1, ..., 9)
2. If the drawing number of the basic unit is A02B-0309-B52n, A02B-0311-B52n, or A02B-0311-B53n (where n is 0, 1, ..., 9)

C BOOT SYSTEM



| | |
|---|-----|
| C.1 OVERVIEW | 610 |
| C.2 SCREEN CONFIGURATION AND OPERATING PROCEDURE | 612 |
| C.3 ERROR MESSAGES AND REQUIRED ACTIONS | 627 |

C.1 OVERVIEW

The boot system load the CNC system software (flash RAM→DRAM), then starts it so that software can be executed.

The boot system provides the following maintenance functions for the CNC:

- (1) Registering a file in flash ROM
 - Reads a file from a memory card, in FAT format, into flash ROM.
- (2) Checking a file (series and edition) in flash ROM
- (3) Deleting a file from flash ROM
- (4) Batch saving and restoration of files of parameters and programs backed up by battery (SRAM area), to and from a memory card
- (5) Saving a file in flash ROM to a memory card
- (6) Formatting of a memory card
- (7) Deleting a file from a memory card

This manual describes the activation of the boot system, as well as the screen displays and operation for the functions listed above.



CAUTION

This control unit supports the use of a memory card as an input/output device. When a flash card is used, however, data can be written to a FANUC-recommended card only. Data can be read in the same way as with an ordinary SRAM card, provided the data has been saved in FAT format. Note that, when a flash card is used, the card capacity is reduced by 128KB.

See the order list for details of the supported memory card types.

C.1.1 Starting the Boot System

In ordinary system activation, the boot system automatically transfers files from flash ROM to DRAM in the background.

The user is not aware of this operation. However, the boot system must be operated manually, from menu screen, when maintenance is to be carried out or when the flash ROM does not contain a required file.

- 1 In system maintenance, for example, to replace a file in ROM
Operation : Turn the power on by simultaneously pressing the two soft keys at the right end.

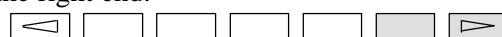

Hold down the two keys until the boot system screen appears.

If soft keys are not provided (for example, when a touch pad is being used), use the MDI numeric keys. Hold down the **6** and **7**

keys until the boot system screen appears.

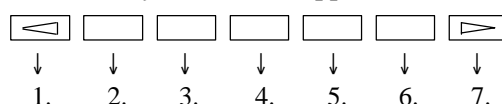

- 2 When the flash memory does not contain a file required to start the CNC

Immediately after the CNC is turned on, the boot system starts transferring files from flash ROM to DRAM. If, for some reason, a file required to start the CNC (NC basic) is not in flash ROM or has been destroyed, the boot system is automatically started.

C.1.2 System Files and User Files

The boot system organizes files in flash ROM into two main groups : system files and user files. These two file types have the following characteristics :

- **System files**
- **User files**

CNC and servo control software provided by FANUC

PMC sequence program (ladder), P-CODE macro program, and other user-created files

C.2 SCREEN CONFIGURATION AND OPERATING PROCEDURE

• MAIN MENU screen

When the boot system is first started, the MAIN MENU screen is displayed. This screen is described below :

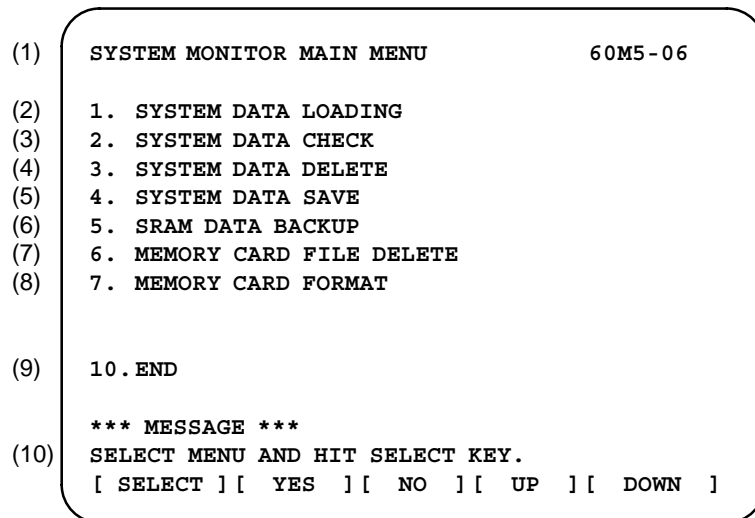

- (1) : Screen title. The series and edition of the boot system appear at the right end.
- (2) : Function for writing data to flash ROM.
- (3) : Function for checking the edition of a file in ROM.
- (4) : Function for deleting a file from flash ROM.
- (5) : Function for making a backup copy of the data stored on the memory card.
- (6) : Function for making a backup copy of the data in SRAM.
- (7) : Function for deleting a file from a memory card.
- (8) : Function for formatting a memory card.
- (9) : Function for terminating the boot system and starting the CNC.
- (10) : Condensed guidance or error message

• Operating procedure

Press the [UP] or [DOWN] soft key to select the desired function. After positioning the cursor to the desired function, press the [SELECT] soft key. Before executing a function, the system may request confirmation from the operator by having him/her press the [YES] or [NO] soft key.

• Basic operation

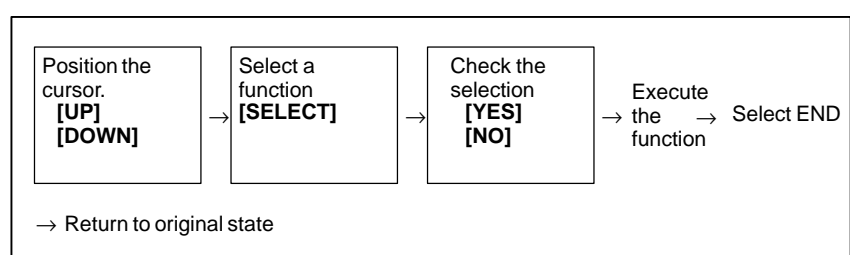

C.2.1 System Data Loading Screen

- **Description**

This screen is used to read a system or user file from a memory card into flash ROM.

- **Screen configuration**

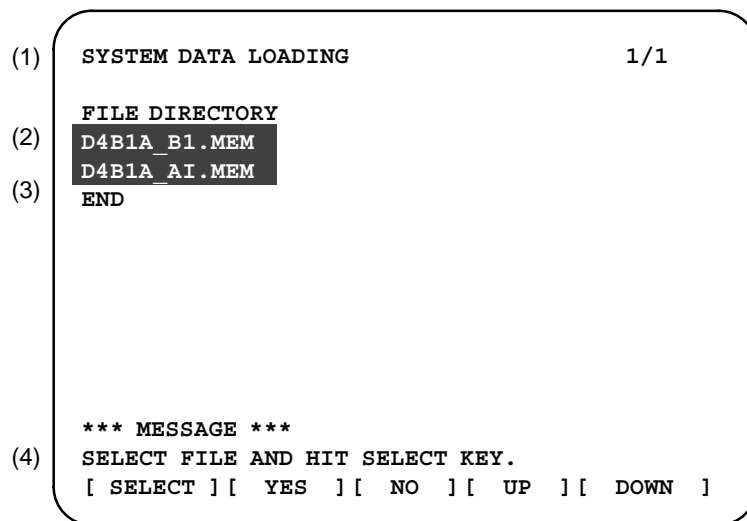

(1): Screen title. The page number (n) and total number of pages (m) are displayed, in n/m format, at the right end.

(2): Files on the memory card

(3): Option for returning to previous menu Message

(4): Message

- **Operating procedure**

1 Position the cursor to the file to be read from the memory card and written to flash ROM. Then, press the [SELECT] soft key.

A single page can list up to eight file names. If the memory card contains nine or more files, the remaining files are displayed on another page.

To display the next page, press the  soft key.

To display the previous page, press the  soft key. The END option is displayed on the last page.

The END option is displayed on the last page.

2 After a file has been selected, the system asks whether that file is to be loaded.

*** MESSAGE ***
LOADING OK ? HIT YES OR NO.

- 3 To start loading, press the [YES] soft key. To cancel, press the [NO] key.

```

*** MESSAGE ***
LOADING FROM MEMORY CARD.
    
```

- 4 When loading terminates normally, the system displays the following message. Press the [SELECT] soft key. If an error occurs, see C.3

```

*** MESSAGE ***
LOADING COMPELETE. HIT SELECT KEY.
    
```

• Others

- 1 Counter display while a file is being loaded

While a file is being loaded, the address of the data currently being accessed is displayed.

```

*** MESSAGE ***
LOADING FROM MEMORY CARD.
ADDRESS 001: ← The counter appears under the
(1) message fld.
    
```

(1): Number of 128-KB management unit in flash ROM

- 2 File name in flash ROM

The boot system identifies a file in flash ROM by the first four characters of the ID in the header. If flash ROM has a file of the same type as a file to be read from the memory card, the file in flash ROM is deleted before the file on the memory card is read. The following table lists the IDs in the header and the contents. Note that these IDs are subject to change without prior notice.

| File name | Contents | File type |
|------------|----------------------------|-------------|
| NC BASIC | Basic 1 | System file |
| NC 2BSIC | Basic 2 | System file |
| DGB0SRVO | Servo | System file |
| GRAPHIC | Graphic | System file |
| NC□ OPTN | Optional□ | System file |
| PS□**** | PMC control software, etc. | System file |
| ETH2 EMB | Embeddedethernet | System file |
| PCD **** | P-CODE macro file/ OMM | User file |
| PMC - **** | Ladder software | User file |

□ : A numeric character, * : An alphabetic character

C.2.2 System Data Check Screen

- **Description**

This screen is used to list files in flash ROM, together with the corresponding numbers of 128-KB management units in each file and the series and edition of the software.

- **Screen configuration**

```
(1)  SYSTEM DATA CHECK                               1/1
(2)  [BOARD:MAIN]
      FILE DIRECTORY (FLASH ROM : 16MB)
(3)  1 NC BASIC ( 10)
      2 NC2 BSIC ( 8)
      3 DGB0SRVO ( 2)
      4 PS0B406G ( 8)
      5 PS1B406G ( 4)
(4)  6 PS2B406G ( 4)
      7 ETH2 EMB ( 8)
      END

(5)  *** MESSAGE ***
      SELECT FILE AND HIT SELECT KEY.
      [ SELECT ][ YES ][ NO ][ UP ][ DOWN ]
```

(1): Screen title

(2): Names of accessing board

(3): Names of files in flash ROM The number of management units constituting each file appears in parentheses to the right of the file name.

(4): Returning to the previous menu

If flash ROM contains many files, END is sometimes not displayed.

In this case, press the continuous menu key () of the soft key display several times. Then, END appears at the end of files.

(5): Message

• **Operating procedure**

- 1 Select the file whose details are required. For example, select “1 NC BASIC (10).”
- 2 The numbers of management units in the selected file are listed, together with the series and edition of the software in each management unit. After checking the listed data, select the [SELECT] soft key to return to the file selection screen.

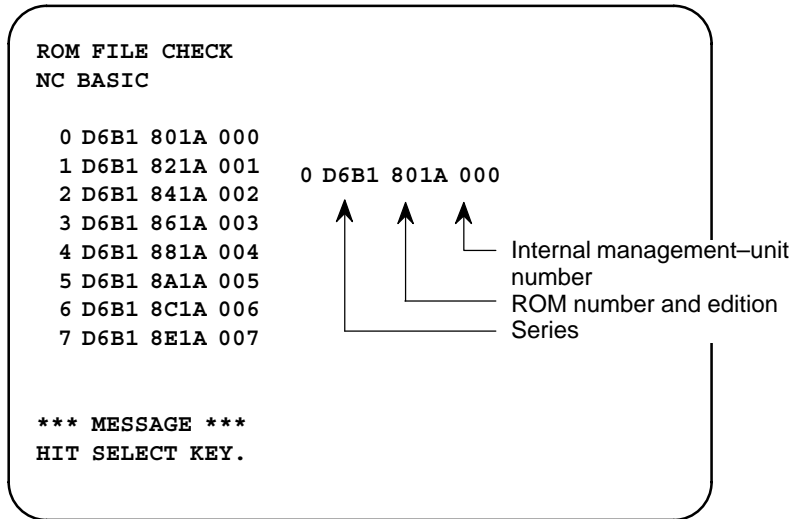

• **Others**

Parity information for the system file and user file
The NC BASIC, DGB0SRVO, and other system files in flash ROM contain parity information in each management unit. If the file name field or parity field on the check screen contains a non-ASC II character or an “@”, the flash ROM may have been destroyed or a damaged file may have been read. Re-read the data from the memory card.
The PMC-SB, PCD 0.5M, and other user files do not contain parity information in each management unit. A non-ASCII character or an “@” may appear in the series/edition information. In this case, it does not indicate that the file has been damaged.

C.2.3 System Data Delete Screen

- **Description**
- **Screen configuration**

This screen is used to delete a user file from flash ROM.

```
(1) SYSTEM DATA CHECK                                1/1
(2) [BOARD:MAIN]
(3) FILE DIRECTORY (FLASH ROM : 16MB)
    1 NC BASIC ( 10)
    2 NC2 BSIC ( 8)
    3 DGB0SRVO ( 2)
    4 PS0B406G ( 8)
    5 PS1B406G ( 4)
(4) 6 PS2B406G ( 4)
    7 ETH2 EMB ( 8)
    END

(5) *** MESSAGE ***
    SELECT FILE AND HIT SELECT KEY.
    [ SELECT ][ YES ][ NO ][ UP ][ DOWN ]
```

- (1): Screen title
- (2): Names of accessing board
- (3): Names of files in flash ROM The number of management units constituting each file appears in parentheses to the right of the file name.
- (4): Returning to the previous menu
If flash ROM contains many files, END is sometimes not displayed. In this case, press the continuous menu key () of the soft key display several times. Then, END appears at the end of files.
- (5): Message

- **Operating procedure**

- 1 Position the cursor to the name of the file to be deleted. Press the **[SELECT]** soft key.
- 2 The system displays the following confirmation message :

```
*** MESSAGE ***
DELETE OK ? HIT YES OR NO.
```

- 3 To start the deletion, press the **[YES]** key. To cancel, press **[NO]**.

```
*** MESSAGE ***
DELETING ROM FILE IN FLASH MEMORY.
```

- 4 When deletion terminates normally, the system displays the following message. Press the [SELECT] key.

```
*** MESSAGE ***
DELETING COMPLETE. HIT SELECT KEY.
```

- Others

- 1 System files and user files on SYSTEM DATA DELETE screen
The system files are protected from accidental deletion. User files, however, are not protected. Protected system files can be overwritten from the SYSTEM DATA LOADING screen.

C.2.4 System Data Save Screen

- Description

This screen is used to write a user file in flash ROM to a memory card. Only user files can be saved from flash ROM to a memory card. System files cannot be saved.

- Screen configuration

```
(1) SYSTEM DATA SAVE
(2) [BOARD:MAIN]
FILE DIRECTORY (FLASH ROM : 16MB)
(3) 1 NC BASIC ( 10)
      2 NC2 BSIC ( 8)
      3 DGB0SRVO ( 2)
      4 PS0B406G ( 8)
      5 PS1B406G ( 4)
(4) 6 PS2B406G ( 4)
      7 ETH2 EMB ( 8)
      END
(5) *** MESSAGE ***
      SELECT FILE AND HIT SELECT KEY.
      [ SELECT ][ YES ][ NO ][ UP ][ DOWN ]
```

- (1): Screen title
(2): Names of accessing board
(3): Names of files in flash memory The number of management units constituting each file appears in parentheses to the right of the file name.
(4): Returning to the previous menu
If flash ROM contains many files, END is sometimes not displayed. In this case, press the continuous menu key () of the soft key display several times. Then, END appears at the end of files.
(5): Message

- **Operating procedure**

- 1 Position the cursor to the name of the file to be deleted. Press the [SELECT] soft key.
- 2 The system displays the following confirmation message :

```
*** MESSAGE ***
SAVE OK ? HIT YES OR NO.
```

- 3 To start saving, press the [YES] key. To cancel, press [NO].

```
*** MESSAGE ***
WRITING FLASH ROM FILE TO MEMORY CARD.
SAVE FILE NAME : PMC_RB.000
```

- 4 When saving terminates normally, the system displays the following message. Press the [SELECT] key. The names of files written to the memory card are listed. Check the file names by, for example, making a note of the list.

```
*** MESSAGE ***
FILE SAVE COMPELETE. HIT SELECT KEY.
SAVE FILE NAME : PMC_RB.000
```

- **Others**

- 1 System files and user files on SYSTEM DATA SAVE screen
The SYSTEM DATA SAVE function provides a safeguard against free copying of the system files.
User files, however, are not protected.
- 2 Names of saved files
Files saved from flash ROM to a memory card have the following names :

| Flash ROM | | File name in Memory card |
|-----------|---|--------------------------|
| PMC-SB | → | PMC_SB.XXX |
| PMC 0.5M | → | PCD_0.5M.XXX |
| PMC 1.0M | → | PCD_10M.XXX |
| PMC 1.5M | → | PCD_15M.XXX |

XXX corresponds to the file extension of MS-DOS format files. A number from 000 to 031 is specified for XXX. For example, if the PMC-RB file in flash ROM is saved to a memory card that does not yet contain a file whose name begins with "PMC-RB", the saved file is named PMC-RB.000. If, however, that file is saved to a memory card that already contains a file named PMC-RB.000, the saved file is named PMC-RB.001. As files are added, the extension is incremented up to a maximum of PMC-RB.031. Any no-longer used numbers in the sequence of the extension numbers are used in ascending order. If two or more files having identical names but different extension numbers are normally saved to the memory card, check the file names displayed subsequently.

C.2.5 SRAM Data Backup Screen

- **Description**

This screen is used to collectively save and restore parameters, programs, and other data, retained after the CNC power in SRAM is turned off, to and from a memory card.

- **Screen configuration**

Select “4 SRAM DATA BACKUP” on the SYSTEM MONITOR MAIN MENU screen. The following screen is displayed.

```
(1) SRAM DATA BACKUP
(2) [BOARD:MAIN]
(3) 1. SRAM BACKUP (CNC → MEMORY CARD)
    2. RESTORE SRAM (MEMORY CARD → CNC)
(4) END
(5) SRAM SIZE : 1.0MB
(6) FILE NAME :

*** MESSAGE ***
(7) SELECT MENU AND HIT SELECT KEY.
    [ SELECT ][ YES ][ NO ][ UP ][ DOWN ]
```

- (1): Screen title
- (2): Names of accessing board
- (3): Menu
- (4): Returning to the previous menu
- (5): Size of SRAM mounted on the CNC
- (6): File name
- (7): Message

● Operating procedure

[Backing up data]

- 1 Select “1. SRAM BACKUP.” The following confirmation message is displayed. The backup file name may be displayed according to the SRAM capacity.
- 2 Press **[YES]** to start backup.

```
*** MESSAGE ***
BACKUP SRAM DATA OK ? HIT YES OR NO.
```

- 3 If a backup file is already on the memory card, you will be prompted to confirm whether to permit overwriting.
- 4 The name of the file being written to the memory card is displayed in the FILE NAME: field.

```
SRAM SIZE   : 1.0MB
FILE NAME   : SRAM1_0A.FDB → MEMORY CARD
*** MESSAGE ***
SRAM DATA WRITING TO MEMORY CARD.
```

Name of the file being saved

- 5 Upon terminating normally, the system displays the following message. Press the **[SELECT]** soft key.

```
*** MESSAGE ***
SRAM BACKUP COMPLETE. HIT SELECT KEY.
```

[Restoring the data]

- 1 Select “2. RESTORE SRAM.” The system displays the following message. Press the **[YES]** key.

```
*** MESSAGE ***
RESTORE SRAM DATA OK ? HIT YES OR NO.
```

- 2 The system displays the following message during restoration.

```
*** MESSAGE ***
RESTORE SRAM DATA FROM MEMORY CARD.
```

- 3 Upon terminating normally, the system displays the following message. Press the **[SELECT]** soft key.

```
*** MESSAGE ***
RESTORE COMPLETE. HIT SELECT KEY.
```

- **Others**

- 1 Name of backup file

The name of the backup file written to the memory card by the SRAM backup function depends on the size of the SRAM installed in the CNC.

When the size of SRAM is 1MB or larger, backup files are created in units of 512 KB.

| Number of files SRAM size | 1 | 2 | 3 | 4 | 5 | 6 |
|------------------------------|--------------|--------------|--------------|--------------|--------------|--------------|
| 256KB | SRAM256A.FDB | | | | | |
| 0.5MB | SRAM0_5A.FDB | | | | | |
| 1.0MB | SRAM1_0A.FDB | SRAM1_0B.FDB | | | | |
| 2.0MB | SRAM2_0A.FDB | SRAM2_0B.FDB | SRAM2_0C.FDB | SRAM2_0D.FDB | | |
| 3.0MB | SRAM3_0A.FDB | SRAM3_0B.FDB | SRAM3_0C.FDB | SRAM3_0D.FDB | SRAM3_0E.FDB | SRAM3_0F.FDB |

**CAUTION**

If data such as parameters was restored from a memory card to SRAM in a system using an absolute pulse coder, set bit 4 (APZ) of parameter No. 1815 to 0, and set the reference point again.

C.2.6 Memory Card File Delete Screen

- **Description**
- **Screen configuration**

This screen is used to delete a file from a memory card.

```
(1)  SRAM DATA LOADING                               1/1
      FILE DIRECTORY
(2)  D6B1A B1.MEM
      D6B1A_A1.MEM
(3)  END

      *** MESSAGE ***
(4)  SELECT FILE AND HIT SELECT KEY.
      [ SELECT ][ YES ][ NO ][ UP ][ DOWN ]
```

- (1): Screen title. The current page number (n) and the total number of pages (m) are displayed, in n/m format, at the right end.
- (2): Files on the memory card
- (3): Option for returning to the previous menu
- (4): Message

- **Operating procedure**

- 1 Press the **[SELECT]** key to select the name of the file to be deleted from the memory card.
- 2 The system displays the following confirmation message. Press the **[YES]** key.

```
*** MESSAGE ***
DELETE OK ? HIT YES OR NO.
```

- 3 When a file has been deleted normally, display the following message. Press the **[SELECT]** key.

```
*** MESSAGE ***
DELETE COMPLETE. HIT SELECT KEY.
```

C.2.7 Memory Card Format Function

- **Description**

This function is used to format a memory card. Memory cards must be formatted before they can be used for the first time or before they can be re-used after their data has been destroyed or lost because of, for example, battery failure.

- **Operating procedure**

- 1 From the SYSTEM MONITOR MAIN MENU screen, select “7. MEMORY CARD FORMAT.”
- 2 The system displays the following confirmation message. Press the [YES] key.

```
*** MESSAGE ***  
MEMORY CARD FORMAT OK ? HIT YES OR NO.
```

- 3 The system displays the following message during formatting :

```
*** MESSAGE ***  
FORMATTING MEMORY CARD.
```

- 4 When a card has been formatted normally, the system display the following message.
 - Press the [SELECT] key.

```
*** MESSAGE ***  
FORMAT COMPLETE. HIT SELECT KEY.
```

C.2.8 Load Basic System Function

- **Description**
- **Operating procedure**

The function is used to terminate the boot system and activate the CNC.

From the MAIN MENU screen, select “9. END.” The system displays the “ARE YOU SURE? HIT YES OR NO” message. To terminate the boot system and activate the CNC, press the **[YES]** soft key. Press the **[NO]** soft key, and you will be brought back to the main menu.

```

*** MESSAGE ***
ARE YOU SURE ? HIT YES OR NO.

[ SELECT ][ YES ][ NO ][ UP ][ DOWN ]

```

- 1 After pressing the **[YES]** soft key

The system checks the NC BASIC system file in the flash ROM. The system displays the following message :

```

*** MESSAGE ***
CHECK CNC BASIC SYSTEM.

[ SELECT ][ YES ][ NO ][ UP ][ DOWN ]

```

When the NC BASIC system file is found to be normal, the system sends the system file to DRAM and starts the NC basic system. During loading, the system blinks the following message.

```

*** MESSAGE ***
LOADING BASIC TO DRAM

[ SELECT ][ YES ][ NO ][ UP ][ DOWN ]

```

If the contents of the NC BASIC SYSTEM file are found to have been damaged or destroyed, the system returns to the processing selection state, in exactly the same way as when the **[NO]** soft key is pressed.

- 2 If the [NO] soft key is pressed, the system returns to the processing selection state as shown below :

```
SYSTEM MONITOR MAIN MENU          60M5-01

1. SYSTEM DATA LOADING
2. SYSTEM DATA CHECK
3. SYSTEM DATA DELETE
4. SYSTEM DATA SAVE
5. SRAM DATA BACKUP
6. MEMORY CARD FILE DELETE
7. MEMORY CARD FORMAT

10. END

*** MESSAGE ***
SELECT MENU AND HIT SELECT KEY.
[ SELECT ][ YES ][ NO ][ UP ][ DOWN ]
```

C.3 ERROR MESSAGES AND REQUIRED ACTIONS

The following table lists and explains error messages in alphabetical order.

| | Message | Description and required action |
|---|--|---|
| B | BOOT ROM PARITY. PLEASE POWER OFF. | The contents of flash memory containing boot software was destroyed. Replace the CPU card. |
| C | CHANGE MEMORY CARD. AND HIT YES OR NO. | The memory card becomes full in the middle of SRAM backup operation. Replace the card with a memory card containing enough free space. |
| D | DELETE ERROR. HIT SELECT KEY. | An attempt to delete a file from flash ROM was unsuccessful. Retry the deletion. If the second attempt also fails, the flash ROM may have been damaged or destroyed. Replace the flash ROM module. |
| | DEVICE ERROR (CNC x) | An attempt to write data to flash ROM was unsuccessful. Retry the write operation. If the second attempt also fails, the flash ROM may have been damaged or destroyed. Replace the flash ROM module. |
| F | FILE SAVE ERROR. HIT SELECT KEY. | An attempt to write a file to a memory card was unsuccessful. Check that the memory card is not damaged. Note) Check that the memory card's battery is not exhausted, that its circuitry has not been damaged, and that it is securely inserted into its slot. |
| | FLASH MEMORY NO SPACE | There is insufficient free flash ROM to store the selected file. Delete any unnecessary files from flash ROM. |
| | FLASH ROM MODULE NOT EXIST. HIT SELECT. | The flash ROM module is not mounted on that CNC system. Put the flash ROM module on the board. |
| G | GRAPHIC SOFT IS NOT FOUND. BOOT STOP. | Graphic software is required. Load appropriate graphic software for the hardware in flash ROM. |
| I | ILLEGAL FORMAT FILE | The selected file cannot be read into flash memory. The selected file or the header information for flash ROM may have been damaged or destroyed. |
| | ILLEGAL FROM MODULE. HIT SELECT KEY. | The flash ROM module ID is illegal. Check the drawing No. of the flash ROM module. |
| | ILLEGAL SRAM MODULE. HIT SELECT KEY. | The SRAM module ID is illegal. Check the drawing No. of the SRAM module. |
| L | LOADING ERROR. HIT SELECT KEY. | An error occurred while loading data into flash ROM. Do not touch the memory card while loading data. |

| | Message | Description and required action |
|---|---|---|
| M | MAX EXTENSION OVER. HIT SELECT KEY. | The extension number added to a file name exceeds 031. Delete any unnecessary backup files from the memory card. |
| | MEMORY CARD BATTERY ALARM. HIT SELECT. | The memory card's battery is exhausted. Replace the battery. |
| | MEMORY CARD FULL. HIT SELECT KEY. | The memory card is full. Delete any unnecessary files from the memory card. Alternatively, replace the memory card with another card having sufficient free space. |
| | MEMORY CARD IS NOT AVAILABLE. HIT SEL. | The use of this memory card is not supported. Use only FANUC-recommended memory cards, as described in the order list. |
| | MEMORY CARD MOUNT ERROR. HIT SELECT KEY | The memory card could not be accessed. Check that the memory card is normal. |
| | MEMORY CARD NOT EXIST. HIT SELECT KEY. | The memory card is not inserted into its slot. Check that the memory card is pushed fully home. |
| | MEMORY CARD PROTECTED.HIT SELECT KEY. | Although writing to the memory card was selected, the write inhibit switch is set. Disable the write inhibit switch. Note) Check that the memory card's battery is not exhausted, that its circuitry has not been damaged, and that it is securely inserted into its slot. |
| | MEMORY CARD TYPE IS NOT AVAILABLE. | Write has been attempted to an incompatible flash memory card. Use only the flash ROM cards recommended by FANUC. Recommended flash ROM cards are listed in the ordering list. |
| | MEMORY CARD RESET ERROR. HIT SELECT KEY. | Access to a memory card failed. The memory card's battery may have gone dead, the memory card may have been damaged electrically, or the memory card may not be inserted in the slot securely. |
| N | NMI OCCURRED. PLEASE POWER OFF. | A hardware or software error occurred. Determine the procedure which causes the error, and report it to FANUC together with the series and edition of the boot software. |
| | P | PLEASE FORMAT FLASH TYPE CARD.HIT SEL. |
| R | ROM PARITY ERROR: NC BASIC. HIT SELECT. | The NC BASIC is parity error. Check whether NC BASIC is in flash ROM, using SYSTEM DATA CHECK. |
| S | SRAM DATA BACKUP ERROR. HIT SELECT KEY. | An attempt to write a backup file to a memory card failed. Check that the memory card is normal. Note) Check that the memory card's battery is not exhausted, that its circuitry has not been damaged, and that it is securely inserted into its slot. |
| | SRAM PARITY OCCURRED. PLEASE POWER OFF. | A parity error was detected during backup operation of SRAM (Caution). |

**CAUTION**

- 1 Action to be taken when an SRAM parity error is detected during backup of SRAM in the boot system

The SRAM area of each CNC shipped from the factory is cleared and is free of parity errors. However, shock applied to the CNC during transportation may cause a parity error in the SRAM area. A parity error may also occur in the SRAM area when the CNC was kept switched off for one year or longer, and the battery has been exhausted. If a parity error occurs in the SRAM area, the data held in the SRAM area is not guaranteed. However, the CNC does not always use the entire SRAM area. A parity error is not detected by hardware unless the part containing the error is read. Therefore, if a parity error occurs in an area not accessed by the CNC, the CNC may operate normally. The SRAM backup function of the boot system reads the entire SRAM area. So, a parity error may occur in the middle of backup operation even when the CNC has operated normally. In this case, the SRAM data of the CNC is not guaranteed, and the data cannot be backed up using the SRAM backup function of the boot system. Nevertheless, the CNC may operate normally. So, it is recommended that necessary data be backed up using the Floppy Cassette or Handy File, data all clear operation be performed, then the backed up data be restored in the CNC. Once all clear operation is performed, the parity error can be removed. Then, the SRAM backup function of the boot system can be used.

D FSSB START-UP PROCEDURE/MATERIALS

| | |
|--|-----|
| D.1 OVERVIEW | 631 |
| D.2 SLAVE | 632 |
| D.3 AUTOMATIC SETTING | 633 |
| D.3.1 [Sample Setting 1] General Configuration (Semi-Closed Loop) | 635 |
| D.3.2 [Sample Setting 2] General Configuration (Closed Loop) | 636 |
| D.3.3 [Sample Setting 3] When the C-axis is a Cs Axis | 638 |
| D.4 MANUAL SETTING 2 | 640 |
| D.5 MANUAL SETTING 1 | 646 |
| D.6 ALARMS | 647 |
| D.7 ACTIONS FOR TROUBLE ENCOUNTERED AT START-UP TIME | 652 |
| D.8 FSSB DATA DISPLAY | 654 |
| D.8.1 Amplifier Setting Screen | 654 |
| D.8.2 Axis Setting Screen | 655 |
| D.8.3 Amplifier Maintenance Screen | 656 |

D.1 OVERVIEW

With a system that uses the FSSB, the parameters below need to be set for axis setting. (Set other parameters as usually done.)

- No. 1023
- No. 1905
- No. 1910 to 1919
- No. 1936, 1937

For setting of these parameters, three methods are available.

1. Automatic setting

By entering data including the relationship between axes and amplifiers on the FSSB setting screen, a calculation for axis setting is made automatically, and parameter Nos. 1023, 1905, 1910 through 1919, 1936, and 1937 are automatically set.

2. Manual setting 2

Enter desired values directly in all of parameter Nos. 1023, 1905, 1910 through 1919, 1936, and 1937.

Before setting the parameters, fully understand the functions of the parameters.

3. Manual setting 1(NOTE)

Based on the setting of No. 1023, default axis setting is performed. Parameter Nos. 1905, 1910 through 1919, 1936, and 1937 need not be set. Automatic setting is not performed.

NOTE

With manual setting 1, usable functions are limited. So, when starting up the FSSB, use automatic setting or manual setting 2 whenever possible.

D.2 SLAVE

In a system using the FSSB, the CNC, servo amplifiers, and separate detector interface units are connected with each other via optical cables. These amplifiers and pulse modules are referred to as slaves. Assume that a 2-axis amplifier consists of two slaves, and a 3-axis amplifier consists of three slaves. Slave numbers (1, 2, 3, ..., 10) are assigned to the slaves in ascending order; a younger number is assigned to a slave that is closer to the CNC.

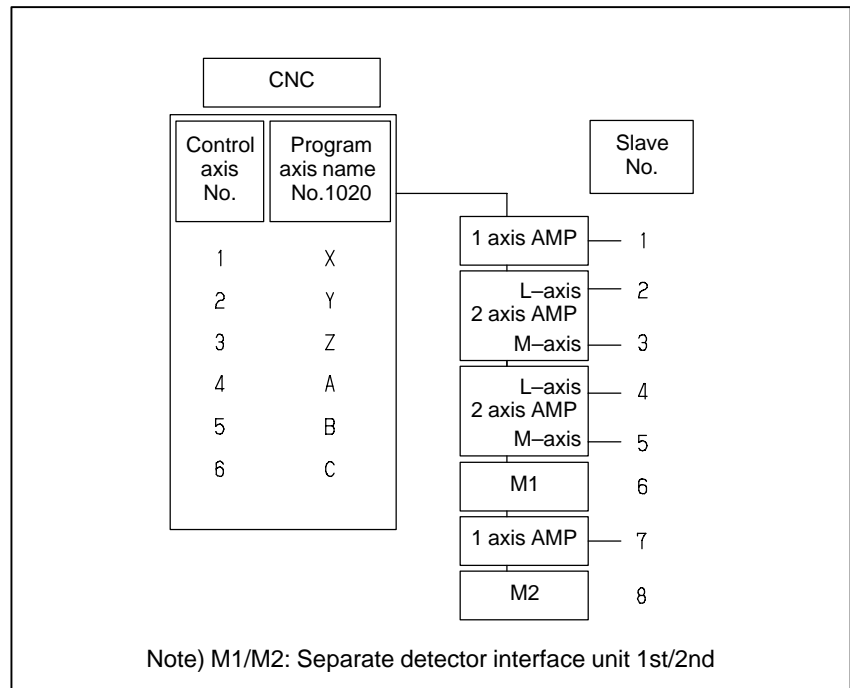



D.3 AUTOMATIC SETTING

When the following parameters are set, automatic setting can be performed using the FSSB setting screen:

Bit 0 of No. 1902 = 0

Bit 1 of No. 1902 = 0

For automatic setting on the FSSB setting screen, use the procedure below.

- 1 Set a servo axis number in No. 1023.
Be sure to match an axis number set in No. 1023 with the total number of axes of the servo amplifiers connected via optical cables.
- 2 On the servo initialization screen, initialize the servo parameters.
- 3 Turn off then on the power to the CNC.
- 4 Press function key  .
- 5 Pressing the continuous menu key  several times displays [FSSB].
- 6 Pressing soft key [FSSB] switches the screen display to the amplifier setting screen (or the FSSB setting screen selected previously), and displays the following soft keys:



- 7 Press soft key [AMP].
- 8 On the amplifier setting screen, set a controlled axis number connected to each amplifier.

The amplifier setting screen lists the slaves in ascending order of slave numbers from top to bottom. So, when setting controlled axis numbers, consider which amplifier axis is to be connected to which CNC axis, sequentially, starting with the amplifier axis closest to the NC. On this setting screen, 0 and duplicate numbers cannot be entered.

| No. | AMP | SERIES | UNIT | CUR. | [AXIS] | NAME |
|-----|------|----------|------|------|--------|------|
| 1 | A1-L | α | SVM | 40AL | [1] | X |
| 2 | A1-M | α | SVM | 12A | [2] | Y |
| 3 | A2-L | β | SVU | 20A | [3] | Z |
| 4 | A3-L | α | SVM | 40A | [4] | A |
| 5 | A3-M | α | SVM | 80A | [5] | B |
| 7 | A4-L | α | SVM | 40AS | [6] | C |

| NO. | EXTRA | | PCB ID |
|-----|-------|---|-----------------------|
| 6 | M1 | A | 0008 DETECTOR (4AXES) |
| 8 | M2 | A | 0008 DETECTOR (4AXES) |

>
MDI **** *
[AMP] [AXIS] [MAINT] [(OPRT)]

- 9 Press soft key [SETTING]. (This soft key appears when a value is entered.)

- 10 Press function key  .

11 Pressing the continuous menu key  several times displays [FSSB].

12 Pressing soft key [FSSB] switches the screen display to the amplifier setting screen, and displays the following soft keys:

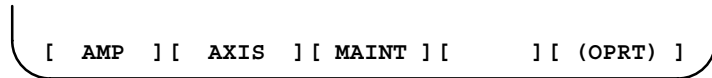

13 Press soft key [AXIS].

14 On the axis setting screen, set information on each axis.

15 The axis setting screen lists the CNC axes in ascending order of axis numbers from top to bottom.

When any of the following is to be performed for each axis, the setting of this screen is required:

- Use of a separate detector
- Exclusive use of a DSP (CPU for servo control) by one axis (for use of a current loop period of 125 μs or learning control, for example)
- Use of a CS axis controlled axis
- Use of tandem control

| (AXIS SETTING) | | | | | | | |
|----------------|------|------|----|----|------|----|------|
| AXIS | NAME | AMP | M1 | M2 | IDSP | CS | TNDM |
| 1 | X | A1-L | 1 | 0 | 0 | 0 | 0 |
| 2 | Y | A1-M | 0 | 1 | 0 | 0 | 0 |
| 3 | Z | A2-L | 0 | 0 | 0 | 0 | 0 |
| 4 | A | A3-L | 2 | 0 | 0 | 0 | 0 |
| 5 | B | A3-M | 0 | 2 | 0 | 0 | 0 |
| 6 | C | A4-L | 0 | 0 | 0 | 0 | 0 |

>
MDI **** * 13:11:56
[AMP] [AXIS] [MAINT] [(OPRT)]

16 Press soft key [SETTING]. (This soft key appears when a value is entered.)

This operation starts an automatic calculation, and parameter Nos. 1023, 1905, 1910 through 1919, 1936, and 1937 are automatically set.

Bit 1 of parameter No. 1902 is set to 1 to indicate that each of these parameters has been set. When the power is turned off then back on, axis settings are made according to each parameter.

D.3.1
[Sample Setting 1]
General Configuration
(Semi-Closed Loop)

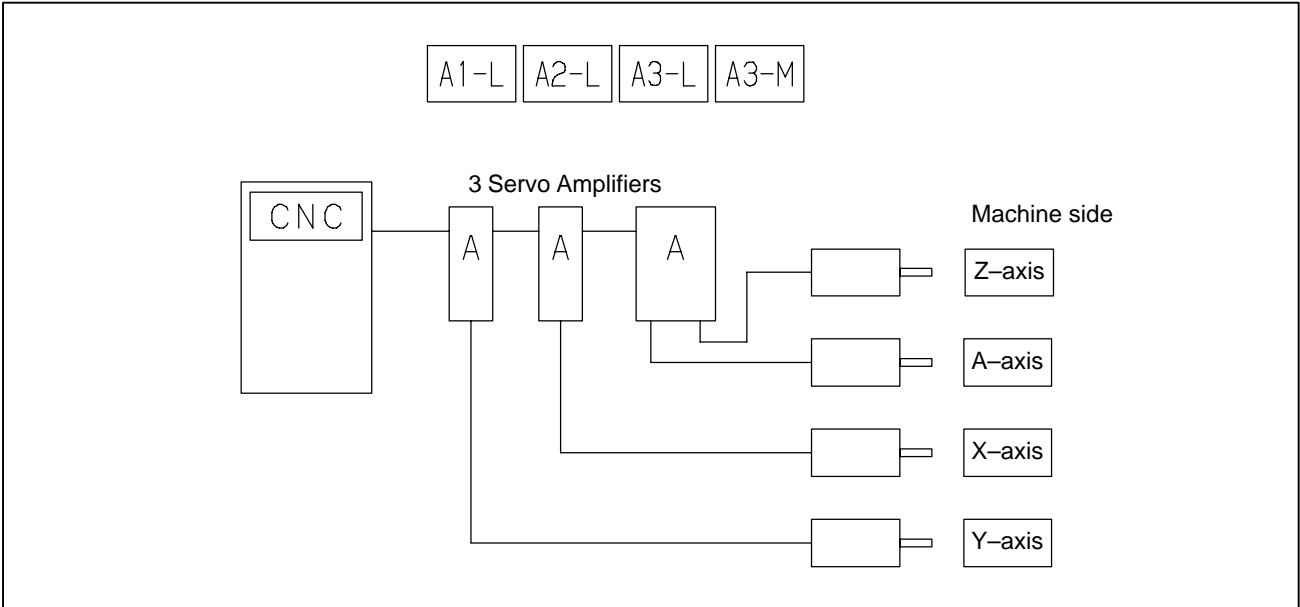

Step 1 Set the following with parameter No. 1023:

- X : 1
- Y : 2
- Z : 3
- A : 4

Step 2 Initialize the servo parameters for each axis.

Step 3 Turn on then off the power to the CNC.

Step 4 Enter the axis numbers on the amplifier setting screen.

```
(AMPLIFIER SETTING)
No.  AMP  SERIES  UNIT  CUR.  [AXIS]  NAME
  1  A1-L   α      SVM   40A   [ 2 ]   Y
  2  A2-L   α      SVM   40A   [ 1 ]   X
  3  A3-L   α      SVM   40A   [ 4 ]   A
  4  A3-M   α      SVM   80A   [ 3 ]   Z
NO.  EXTRA  TYPE  PCB ID

>
MDI **** * 13:11:56
[ AMP ] [ AXIS ] [ MAINT ] [ (OPRT) ]
```

Step 5 Press soft key [SETTING]. (This soft key appears when a value is entered.)

Step 6 Press function key  .

Step 7 Pressing the continuous menu key  several times displays [FSSB].

Step 8 Pressing soft key [FSSB] switches the screen display to the amplifier setting screen, and displays the following soft keys:

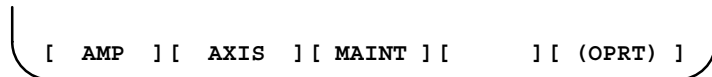

Step 9 Press soft key [AXIS].

Step 10 Press soft key [(OPRT)] without entering any data, then press soft key [SETTING].

Step 11 Turn off then on the power to the CNC. This completes the setting.

D.3.2 [Sample Setting 2] General Configuration (Closed Loop)

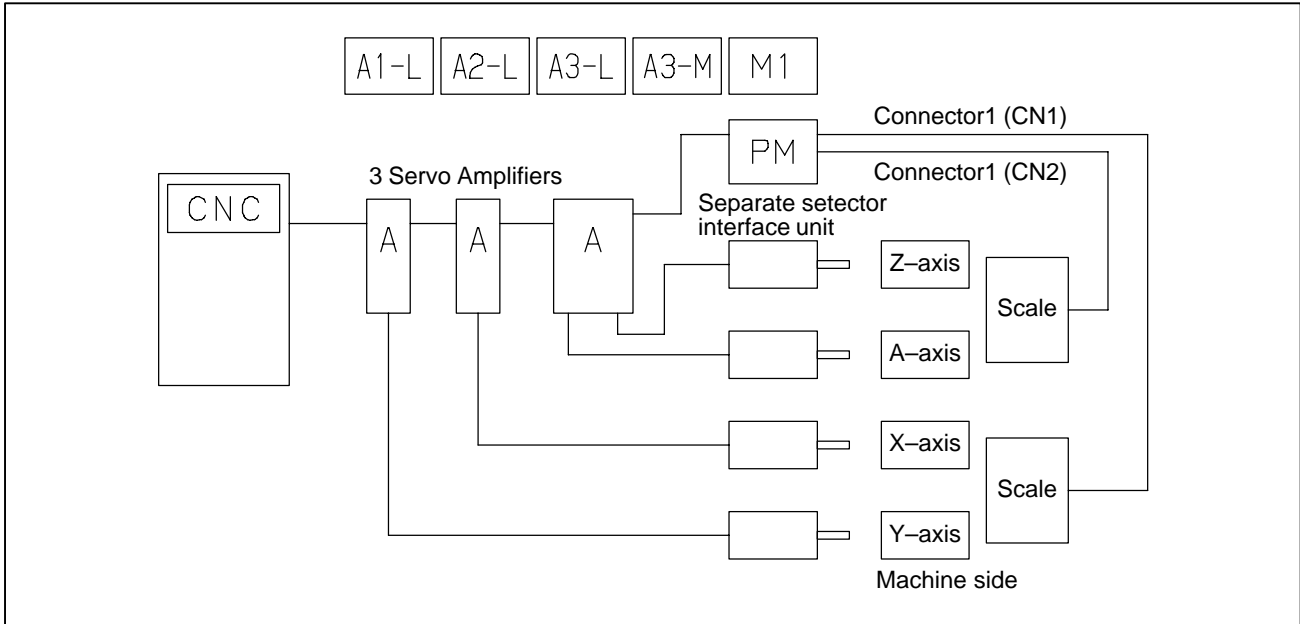

Step 1 Set the following with parameter No. 1023:

- X : 1
- Y : 2
- Z : 3
- A : 4

Step 2 Initialize the servo parameters for each axis.

Step 3 Turn on then off the power to the CNC.

Step 4 Enter the axis numbers on the amplifier setting screen.

(Amplifier setting)

| No. | AMP | SERIES | UNIT | CUR. | [AXIS] | NAME |
|-----|-------|----------|--------|------------------|--------|------|
| 1 | A1-L | α | SVM | 40A | [2] | Y |
| 2 | A2-L | α | SVM | 40A | [1] | X |
| 3 | A3-L | α | SVM | 40A | [4] | A |
| 4 | A3-M | α | SVM | 80A | [3] | Z |
| NO. | EXTRA | TYPE | PCB ID | | | |
| 5 | M1 | A | 0008 | DETECTOR (4AXES) | | |

```

>
MDI **** * 13:11:56
[ AMP ] [ AXIS ] [ MAINT ] [ (OPRT) ]

```

Step 5 Press soft key [SETTING]. (This soft key appears when a value is entered.)

Step 6 Press function key  .

Step 7 Pressing the continuous menu key  several times displays [FSSB].

Step 8 Pressing soft key [FSSB] switches the screen display to the amplifier setting screen, and displays the following soft keys:

```

[ AMP ] [ AXIS ] [ MAINT ] [ (OPRT) ]

```

Step 9 Press soft key [AXIS].

Step 10 Set the separate detector on the axis setting screen. (Separate detector interface unit: M1/M2)

(AXIS SETTING)

| AXIS | NAME | AMP | M1 | M2 | 1DSP | Cs | TNDM |
|------|------|------|----|----|------|----|------|
| 1 | X | A2-L | 0 | 0 | 0 | 0 | 0 |
| 2 | Y | A1-L | 1 | 0 | 0 | 0 | 0 |
| 3 | Z | A3-M | 0 | 0 | 0 | 0 | 0 |
| 4 | A | A3-L | 2 | 0 | 0 | 0 | 0 |

```

>
MDI **** * 13:11:56
[ AMP ] [ AXIS ] [ MAINT ] [ (OPRT) ]

```

Step 11 Press soft key [SETTING]. (This soft key is displayed when a value is entered.)

Step 12 Set bit 1 of parameter No. 1815 to 1 for the Y-axis and A-axis.

Step 13 Turn off then on the power to the CNC. This completes the setting.

D.3.3

[Sample Setting 3]

When the C-Axis is a Cs Axis

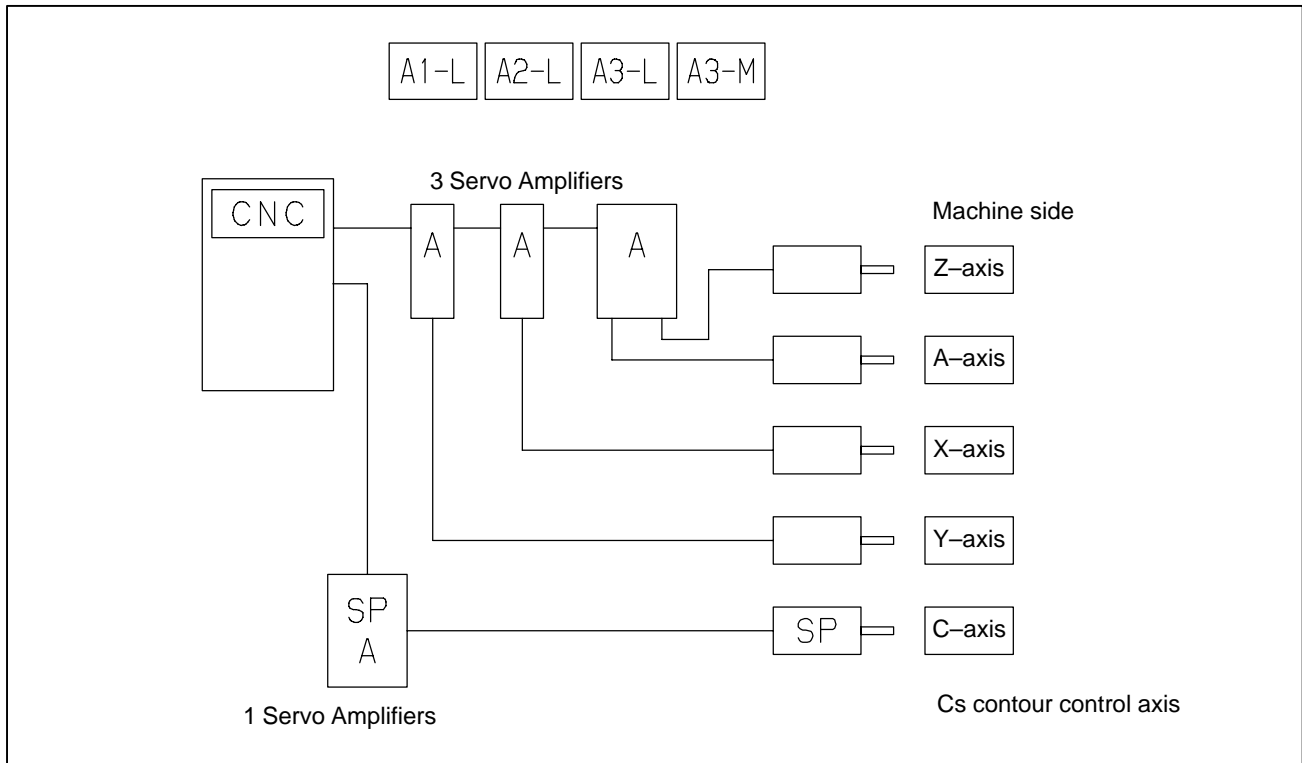

Step 1 Set the following with parameter No. 1023:

X : 1

Z : 2

C : -1

Y : 3

A : 4

Step 2 Initialize the servo parameters for each axis.

Step 3 Initialize the spindle parameters for the spindle.

Step 4 Turn on then off the power to the CNC.

Step 5 Enter the axis numbers on the amplifier setting screen.

```
(AMPLIFIER SETTING)
No.  AMP  SERIES  UNIT  CUR.  [AXIS]  NAME
  1  A1-L   α     SVM   40A   [ 2 ]   Z
  2  A2-L   α     SVM   40A   [ 1 ]   X
  3  A3-L   α     SVM   40A   [ 4 ]   A
  4  A3-M   α     SVM   80A   [ 3 ]   Y
NO.  EXTRA  TYPE  PCB ID

>
MDI **** * 13:11:56
[ AMP ] [ AXIS ] [ MAINT ] [ (OPRT) ]
```

Step 6 Press soft key [SETTING]. (This soft key appears when a value is entered.)

Step 7 Press function key .

Step 8 Pressing the continuous menu key  several times displays [FSSB].

Step 9 Pressing soft key [FSSB] switches the screen display to the amplifier setting screen, and displays the following soft keys:

```
[ AMP ] [ AXIS ] [ MAINT ] [ (OPRT) ]
```

Step 10 Press soft key [AXIS].

Step 11 Set the Cs contour axis on the axis setting screen. (Cs)

```
(AXIS SETTING)
AXIS  NAME  AMP  M1  M2  1DSP  Cs  TNDM
  1   X   A2-L  0   0   0     0   0
  2   Z   A1-L  0   0   0     0   0
  3   C   -    0   0   0     1   0
  4   Y   A3-M  0   0   0     0   0
  5   A   A3-L  0   0   0     0   0

>
MDI **** * 13:11:56
[ AMP ] [ AXIS ] [ MAINT ] [ (OPRT) ]
```

Step 12 Press soft key [SETTING]. (This soft key appears when a value is entered.)

Step 13 Turn off then on the power to the CNC. This completes the setting.

D.4 MANUAL SETTING 2

When the following parameters are set, each axis can be set manually:

No.1902#0=1

No.1902#1=0

When performing manual setting, set parameter Nos. 1023, 1905, 1910 through 1919, 1936, and 1937, fully understanding their functions.

| | | | | | | | | |
|------|----|----|----|----|----|----|-----|-----|
| | #7 | #6 | #5 | #4 | #3 | #2 | #1 | #0 |
| 1902 | | | | | | | ASE | FMD |

[Data type] Bit

#0 (FMD) The FSSB setting mode is:

0 : Automatic setting mode. (When data including the relationship between axes and amplifiers is set on the FSSB setting screen, parameter Nos. 1023, 1905, 1910 through 1919, 1936, and 1937 are automatically set.)

1 : Manual setting 2 mode. (Parameter Nos. 1023, 1905, 1910 through 1919, 1936, and 1937 are set manually.)

#1 (ASE) When the FSSB setting mode is the automatic setting mode (when bit 0 of parameter No. 1902 = 0), automatic setting is:

0 : Not completed.

1 : Completed.

(This bit is automatically set to 1 when automatic setting is completed.)

| | | | | | | | | |
|------|-----|-----|----|----|----|----|----|-----|
| | #7 | #6 | #5 | #4 | #3 | #2 | #1 | #0 |
| 1905 | PM2 | PM1 | | | | | | FSL |

[Data type] Bit axis

#0 (FSL) The type of interface between servo amplifiers and servo software is:

0 : Fast type.

1 : Slow type.

Two servo data transfer interface types are available: the fast type and slow type.

Set this bit so that the following conditions are satisfied:

- When a 1-axis amplifier is used, both of the fast and slow types can be used.
- When a 2-axis amplifier is used, the fast type must not be used for both axes. The slow type can be used for both axes.
- When a 3-axis amplifier is used, the first and second axes must satisfy the condition for a 2-axis amplifier, and the third axis must satisfy the condition for a one-axis amplifier.
- With an axis for which an odd number is set in parameter No. 1023, the fast type must be used. The slow type can also be used, however, for an EGB workpiece axis, learning-control axis, high-speed current loop axis, and high-speed interface axis.
- Only the slow type can be used with an axis for which an even number is set in parameter No. 1023. (Be sure to set this bit to 1).

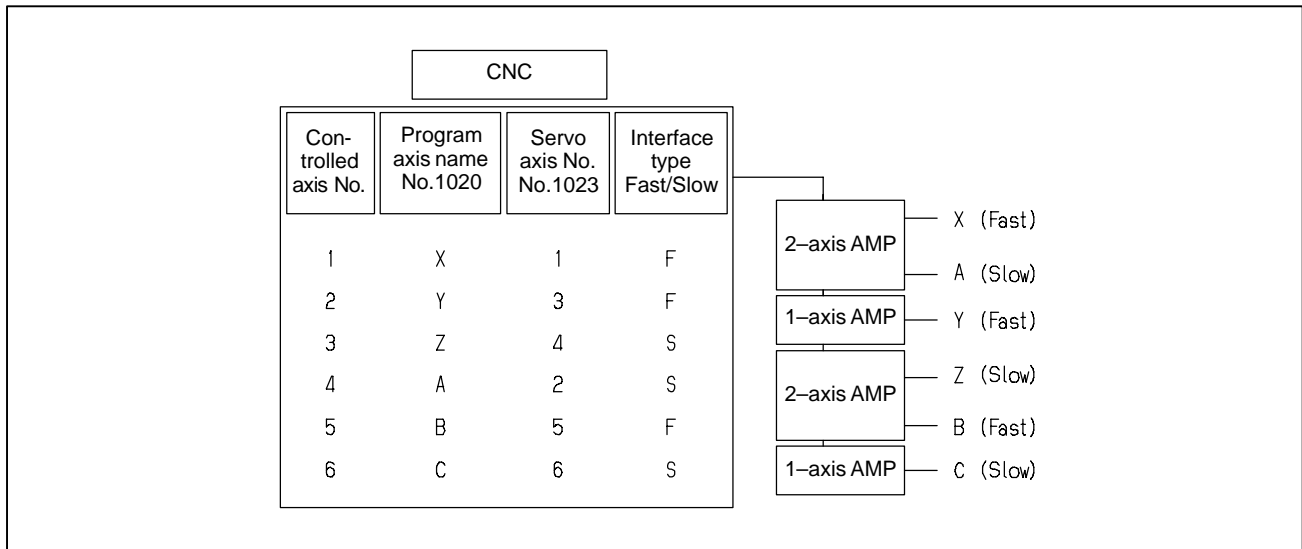

#6 (PM1) The first separate detector interface unit is:

0 : Not used.

1 : Used.

#7 (PM2) The second separate detector interface unit is:

0 : Not used.

1 : Used.

This parameter is automatically set by data input on the FSSB setting screen when the FSSB setting mode is the automatic setting mode (when bit 0 of parameter No. 1902 = 0). When the manual setting 2 mode is used (when bit 0 of parameter No. 1902 = 1), be sure to enter necessary data directly.

When a separate detector interface unit is used, connector numbers (parameter Nos. 1936 and 1937) need to be set.

| | | |
|-----|------|---|
| PRM | 1910 | Address conversion table value for slave 1 (ATR) |
| PRM | 1911 | Address conversion table value for slave 2 (ATR) |
| PRM | 1912 | Address conversion table value for slave 3 (ATR) |
| PRM | 1913 | Address conversion table value for slave 4 (ATR) |
| PRM | 1914 | Address conversion table value for slave 5 (ATR) |
| PRM | 1915 | Address conversion table value for slave 6 (ATR) |
| PRM | 1916 | Address conversion table value for slave 7 (ATR) |
| PRM | 1917 | Address conversion table value for slave 8 (ATR) |
| PRM | 1918 | Address conversion table value for slave 9 (ATR) |
| PRM | 1919 | Address conversion table value for slave 10 (ATR) |

[Data type] Byte

[Valid data range] 0 to 7, 16, 40, 48

Set an address conversion table value for each of slave 1 through 10.

The slave is the generic name of a servo amplifier or separate detector interface unit connected to the CNC via an FSSB optical cable. The numbers from 1 to 10 are assigned to the slaves in ascending order; a younger number is assigned to a slave that is closer to the CNC. A 2-axis amplifier consists of two slaves, and a 3-axis amplifier consists of three slaves. Set each of the parameters as described below according to which of the three cases is applicable: the slave is an amplifier, the slave is a separate detector interface unit, or there is no slave.

When the slave is an amplifier:

Set a value obtained by subtracting 1 from the setting of parameter No. 1023 for the axis to which the amplifier is assigned.

When the slave is a separate detector interface unit:

- For the first separate detector interface unit (closest to the CNC), set 16.
- For the second separate detector interface unit (farthest from the CNC), set 48.

When there is no slave:

Set 40.

These parameters are automatically set by data input on the FSSB setting screen when the FSSB setting mode is the automatic setting mode (when bit 0 of parameter No. 1902 = 0). When the manual setting 2 mode is used (when bit 0 of parameter No. 1902 = 1), be sure to enter necessary data directly.

○ Axis configuration and example of parameter setting

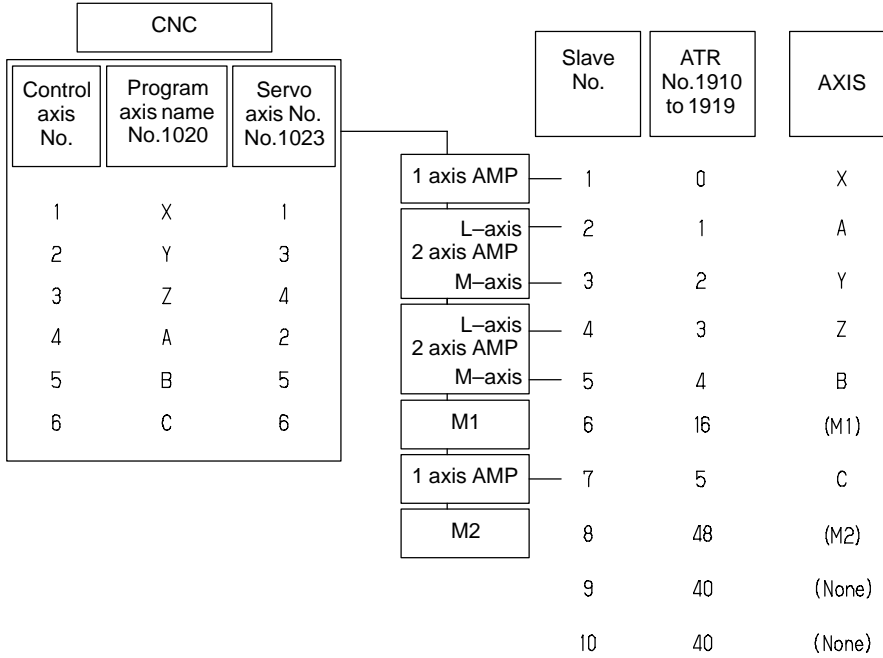

Note) M1/M2 : Separate detector interface unit 1 st/2 nd

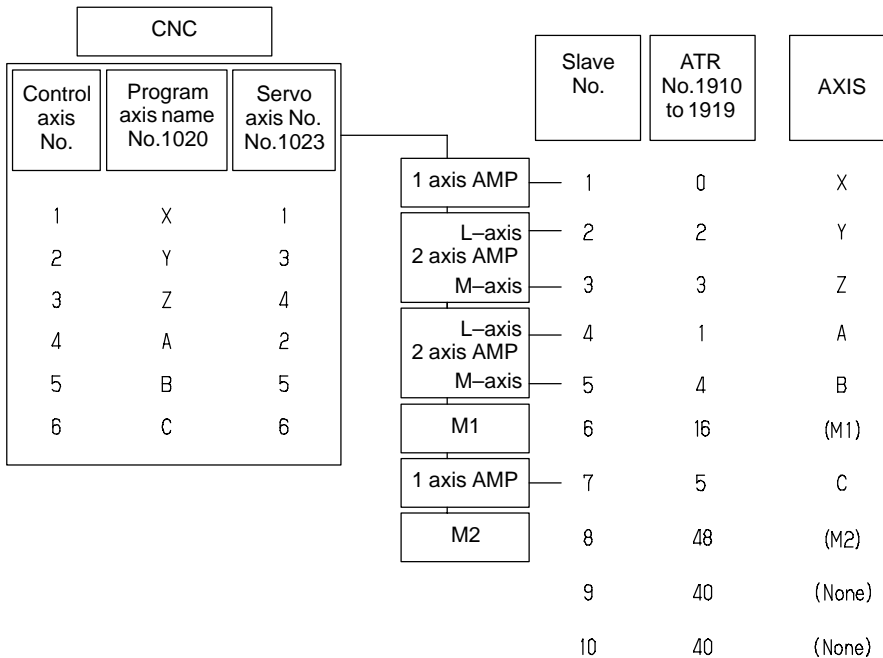

Note) M1/M2 : Separate detector interface unit 1 st/2 nd

| | | |
|-----|------|--|
| PRM | 1936 | Connector number for the first separate detector interface unit |
| PRM | 1937 | Connector number for the second separate detector interface unit |

[Data type] Byte axis

[Valid data range] 0 to 7

When using a pulse module, set a value obtained by subtracting 1 from the pulse module connector number for each axis. That is, for connector numbers 1 to 8, set the values 0 to 7. Moreover, set bits 6 and 7 of parameter No. 1905. Set 0 for an axis for which no pulse module is used. The user can freely determine which connector to use for which axis. Use connector numbers, starting with younger numbers. For example, connector number 4 cannot be used without using connector number 3.

Example:

| Controlled axis | First connector number | Second connector number | No.1936 | No.1937 | No.1905 (#7,#6) |
|-----------------|------------------------|-------------------------|---------|---------|-----------------|
| X | 1 | Not used | 0 | 0 | 0,1 |
| Y | Not used | 2 | 0 | 1 | 1,0 |
| Z | Not used | 1 | 0 | 0 | 1,0 |
| A | Not used | Not used | 0 | 0 | 0,0 |
| B | 2 | Not used | 1 | 0 | 0,1 |
| C | Not used | 3 | 0 | 2 | 1,0 |

These parameters are automatically set by data input on the FSSB setting screen when the FSSB setting mode is the automatic setting mode (when bit 0 of parameter No. 1902 = 0). When the manual setting 2 mode is used (when bit 0 of parameter No. 1902 = 1), be sure to enter necessary data directly.

○ Axis configuration and example of parameter setting in the manual setting 2 mode

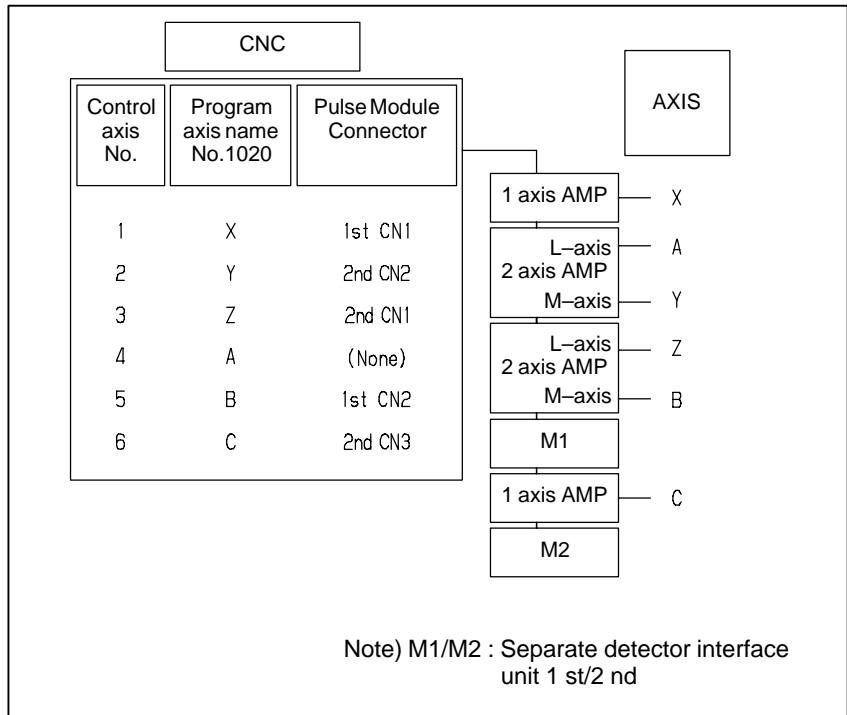

| No. | 1902#0 FSBMD |
|-----|--------------|
| | 1 |

| No. | 1910 | 1911 | 1912 | 1913 | 1914 | 1915 | 1916 | 1917 | 1918 | 1919 |
|-----|------|------|------|------|------|------|------|------|------|------|
| | 0 | 1 | 2 | 3 | 4 | 16 | 5 | 48 | 40 | 40 |

| No. | 1023 | 1905#0 FBSL | 1905#6 FSBM1 | 1905#7 FSBM2 | 1936 | 1937 |
|-----|------|-------------|--------------|--------------|------|------|
| X | 1 | 0 | 1 | 0 | 0 | 0 |
| Y | 3 | 0 | 0 | 1 | 0 | 1 |
| Z | 4 | 1 | 0 | 1 | 0 | 0 |
| A | 2 | 1 | 0 | 0 | 0 | 0 |
| B | 5 | 0 | 1 | 0 | 1 | 0 |
| C | 6 | 1 | 0 | 1 | 0 | 2 |

D.5 MANUAL SETTING 1

When the following parameters are set, manual setting 1 is enabled:

Bit 0 of No. 1092 = 0

Bit 1 of No. 1902 = 0

Nos. 1910 through 1919 = 0 (all set to 0)

In manual setting 1, a setting is made at power-on so that the value set in parameter No. 1023 is assumed to be a slave number. That is, an axis for which the value of parameter No. 1023 is 1 is connected to the amplifier closest to the CNC. An axis for which the value of parameter No. 1023 is 2 is connected to the amplifier next closest to the CNC.

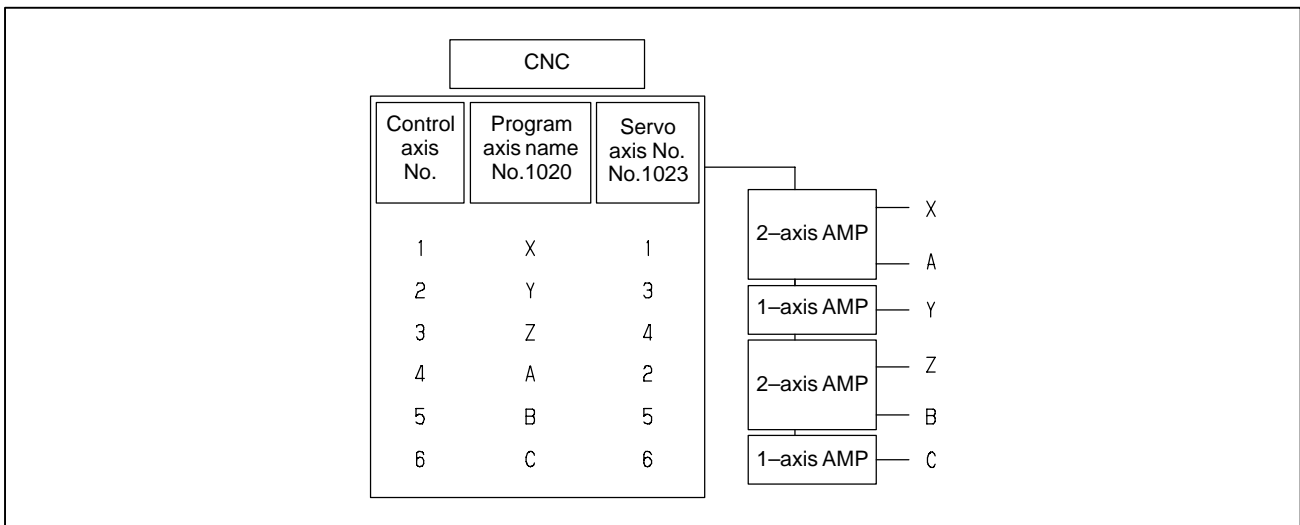

Note that some functions and settings cannot be used in manual setting 1 as described below.

- No separate detector interface unit can be used.
This means that no separate position detector can be used.
- Set sequential numbers in parameter No. 1023.
For example, 3 cannot be set for an axis without setting 2 for any axis.
- The following servo functions cannot be used:
 - High-speed current loop

D.6 ALARMS

Alarms related to pulse coders

| NC alarm No. | Message | Description |
|--------------|------------------------------------|--|
| 360 | n AXIS : ABNORMAL CHECKSUM (INT) | A checksum error occurred in the built-in pulse coder. |
| 361 | n AXIS : ABNORMAL PHASE DATA (INT) | A phase data error occurred in the built-in pulse coder. |
| 362 | n AXIS : ABNORMAL REV.DATA (INT) | A rotation speed count error occurred in the built-in pulse coder. |
| 363 | n AXIS : ABNORMAL CLOCK (INT) | A clock error occurred in the built-in pulse coder. |
| 364 | n AXIS : SOFT PHASE ALARM (INT) | The digital servo software detected invalid data in the built-in pulse coder. |
| 365 | n AXIS : BROKEN LED (INT) | An LED error occurred in the built-in pulse coder. |
| 366 | n AXIS : PULSE MISS (INT) | A pulse error occurred in the built-in pulse coder. |
| 367 | n AXIS : COUNT MISS (INT) | A count error occurred in the built-in pulse coder. |
| 368 | n AXIS : SERIAL DATA ERROR (INT) | Communication data from the built-in pulse coder cannot be received. |
| 369 | n AXIS : DATA TRANS. ERROR (INT) | A CRC or stop bit error occurred in the communication data being received from the built-in pulse coder. |
| 380 | n AXIS : BROKEN LED (EXT) | The LED of separate detector is erroneous. |
| 381 | n AXIS : ABNORMAL PHASE (EXT LIN) | A phase data error occurred in the separate linear scale. |
| 382 | n AXIS : COUNT MISS (EXT) | A pulse error occurred in the separate detector. |
| 383 | n AXIS : PULSE MISS (EXT) | A count error occurred in the separate detector. |
| 384 | n AXIS : SOFT PHASE ALARM (EXT) | The digital servo software detected invalid data in the separate detector. |
| 385 | n AXIS : SERIAL DATA ERROR (EXT) | Communication data from the separate detector cannot be received. |
| 386 | n AXIS : DATA TRANS. ERROR (EXT) | A CRC or stop bit error occurred in the communication data being received from the separate detector. |
| 387 | n AXIS : ABNORMAL ENCODER (EXT) | An error occurs in the separate detector. For details, contact the manufacturer of the scale. |

Alarms related to servo amplifiers

| NC alarm No. | Message | Description |
|--------------|------------------------------------|--|
| 432 | n AXIS : CNV. LOW VOLT CONTROL | 1) PSM: Control power voltage has dropped. 2) PSMR: The control power supply voltage has dropped. 3) β series SVU: The control power supply voltage has dropped. |
| 433 | n AXIS : CNV. LOW VOLT DC LINK | 1) PSM: The DC link voltage has dropped. 2) PSMR: The DC link voltage has dropped. 3) α series SVU: The DC link voltage has dropped. 4) β series SVU: The DC link voltage has dropped. |
| 434 | n AXIS : INV. LOW VOLT CONTROL | SVM: The control power supply voltage has dropped. |
| 435 | n AXIS : INV. LOW VOLT DC LINK | SVM: The DC link voltage has dropped. |
| 436 | n AXIS : SOFTTHERMAL (OVC) | The digital servo software detected the soft thermal state (OVC). |
| 437 | n AXIS : CNV. OVERCURRENT POWER | PSM: Overcurrent flowed into the input circuit. |
| 438 | n AXIS : INV. ABNORMAL CURRENT | 1) SVM: The motor current is too high. 2) α series SVU: The motor current is too high. 3) β series SVU: The motor current is too high. |
| 439 | n AXIS : CNV. OVERVOLT POWER | 1) PSM: The DC link voltage is too high. 2) PSMR: The DC link voltage is too high. 3) α series SVU: The C link voltage is too high. 4) β series SVU: The link voltage is too high. |
| 440 | n AXIS : CNV. EX DECELERATION POW. | 1) PSMR: The regenerative discharge amount is too large. 2) α series SVU: The regenerative discharge amount is too large. Alternatively, the regenerative discharge circuit is abnormal. |
| 441 | n AXIS : ABNORMAL CURRENT OFFSET | The digital servo software detected an abnormality in the motor current detection circuit. |
| 442 | n AXIS : CNV. CHARGE FAILURE | 1) PSM: The spare discharge circuit of the DC link is abnormal. 2) PSMR: The spare discharge circuit of the DC link is abnormal. |
| 443 | n AXIS : CNV. COOLING FAN FAILURE | 1) PSM: The internal stirring fan failed. 2) PSMR: The internal stirring fan failed. 3) β series SVU: The internal stirring fan failed. |

| NC alarm No. | Message | Description |
|--------------|------------------------------------|--|
| 444 | n AXIS : INV. COOLING FAN FAILURE | SVM: The internal stirring fan failed. |
| 445 | n AXIS : SOFT DISCONNECT ALARM | The digital servo software detected a broken wire in the pulse coder. |
| 446 | n AXIS : HARD DISCONNECT ALARM | A broken wire in the built-in pulse coder was detected by hardware. |
| 447 | n AXIS : HARD DISCONNECT (EXT) | A broken wire in the separate detector was detected by hardware. |
| 448 | n AXIS : UNMATCHED FEEDBACK ALARM | The sign of feedback data from the built-in pulse coder differs from that of feedback data from the separate detector. |
| 449 | n AXIS : INV. IPM ALARM | 1) SVM: IPM (intelligent power module) detected an alarm. 2) α series SVU: IPM (intelligent power module) detected an alarm. |
| 453 | n AXIS : SPC SOFT DISCONNECT ALARM | Software disconnection alarm of the α pulse coder. Turn off the power to the CNC, then remove and insert the pulse coder cable. If this alarm is issued again, replace the pulse coder. |
| 456 | ILLEGAL CURRENT LOOP | The current control cycle settings (parameter No. 2004, bit 0 of parameter No. 2003, and bit 0 of parameter No. 2013) are incorrect. Possible problems are as follows. <ul style="list-style-type: none"> – For the two axes whose servo axis numbers (settings of parameter No. 1023) are an odd number followed by an even number (a pair of axes 1 and 2 or axes 5 and 6, for example), a different current control cycle is set for each of the axes. – The requirements for slaves needed for the set current control cycle, including the number, type, and connection method of them, are not satisfied. |
| 457 | ILLEGAL HI HRV (250US) | Use of high-speed HRV is specified although the current control cycle is 200 μ s. |
| 458 | CURRENT LOOP ERROR | The current control cycle setting does not match the actual current control cycle. |
| 459 | HI HRV SETTING ERROR | Of two axes having adjacent servo axis numbers (parameter No. 1023), odd number and even number, high-speed HRV control can be performed for one axis and not for the other. |

Alarms related to servo amplifiers

| NC alarm No. | Message | Description |
|--------------|----------------------------------|---|
| 460 | n AXIS : FSSB DISCONNECT | FSSB communication was disconnected suddenly. The possible causes are as follows: 1) The FSSB communication cable is disconnected or broken. 2) The power to the amplifier dropped suddenly. 3) The amplifier issued a low-voltage alarm. |
| 461 | n AXIS : ILLEGAL AMP INTERFACE | Both axes of a 2-axis amplifier were assigned to the fast type interface. |
| 462 | n AXIS : SEND CNC DATA FAILED | Because of an FSSB communication error, a slave could not receive correct data. |
| 463 | n AXIS : SEND SLAVE DATA FAILED | Because of an FSSB communication error, the servo system could not receive correct data. |
| 466 | n AXIS : MOTOR/AMP COMBINATION | The maximum current value of the amplifier does not match the maximum current value of the motor. |
| 467 | n AXIS : ILLEGAL SETTING OF AXIS | The following servo functions are not enabled even when an axis using a DSP exclusively is set on the axis setting screen: 1) Learning control (bit 5 of parameter No. 2008 = 1) 2) High-speed current loop (bit 0 of parameter No. 2004 = 1) 3) High-speed interface axis (bit 4 of parameter No. 2005 = 1) |
| 468 | HI HRV SETTING ERROR(AMP) | Use of high-speed HRV is specified for a controlled axis of an amplifier which does not support high-speed HRV. |

P/S alarms

| NC alarm No. | Message | Description |
|--------------|----------------------------------|---|
| 5134 | FSSB : OPEN READY TIME OUT | The FSSB did not become ready to open during initialization. |
| 5135 | FSSB : ERROR MODE | The FSSB entered an error mode. |
| 5136 | FSSB : NUMBER OF AMPS IS SMALL | The number of amplifiers recognized by the FSSB is insufficient, compared with the number of controlled axes. |
| 5137 | FSSB : CONFIGURATION ERROR | The FSSB detected a configuration error. |
| 5138 | FSSB : AXIS SETTING NOT COMPLETE | Axis setting has not been performed in automatic setting mode. Perform axis setting using the FSSB setting screen. |
| 5139 | FSSB : ERROR | The servo system could not be initialized normally. The cause may be an optical cable failure or incorrect connection with an amplifier and other modules. |
| 5197 | FSSB : OPEN TIME OUT | The FSSB did not open when the CNC had allowed the FSSB to open. |
| 5198 | FSSB : ID DATA NOT READ | The initial ID information for the amplifier cannot be read because of a failure in the temporary assignment. |
| 5311 | FSSB : ILLEGAL CONNECTION | <p>A connection related to FSSB is illegal. This alarm is issued when either of the following is found:</p> <ol style="list-style-type: none"> 1 Two axes having adjacent servo axis numbers (parameter No. 1023), odd number and even number, are assigned to amplifiers to which different FSSB systems are connected. 2 The system does not satisfy the requirements for performing HRV control, and use of two pulse modules connected to different FSSB systems having different FSSB current control cycles is specified. |

D.7 ACTIONS FOR TROUBLE ENCOUNTERED AT START-UP TIME

- MDI input is abnormal (each time data is entered, the power needs to be turned off).

First, disconnect the optical cable of the NC, then turn off then on the power. Next, check the items below.

(A) Check parameter No. 1902.

Action: hen parameter
No. 1902 = 00000000, set the following:
No. 1905 = 00000000
Nos. 1910 through 1919 = 0

Action: hen parameter
No. 1902 = 00000001 or 00000010, set the following:
No. 1905 = Appropriate value
Nos. 1910 through 1919 = Appropriate value

(B) When bit 1 of parameter No. 1815 = 1, check parameter Nos. 1910 through 1919 to see if 16 or 48 is set.

Action: If neither 16 nor 48 is set, set bit 1 of No. 1815 to 1.

(C) Check if communication is open (the green LED is on).

Action: If communication is not open, check the power supply for the amplifier and optical cable connection.
- The separate detector can be recognized, but feedback pulses from the separate detector are abnormal.
- (A) Check parameter No. 1902.
- Action: The setting of parameter
No. 1902 = 00000000 is incorrect. When parameter
No. 1902 = 00000001, set the following:
No. 1905 = 01000000 or 10000000
Nos. 1910 through 1919 = Appropriate value
Nos. 1936 and 1937 = Appropriate value
- Action: When parameter No. 1902 = 00000010, set connector numbers for M0 and M1 in axis setting on the FSSB screen.
- In axis setting on the FSSB screen, connector numbers for M1 and M2 cannot be set.
- Action: Check the FSSB screen to see if separate detector interface unit IDs are read correctly. If pulse module IDs are not read correctly, check the separate detector interface unit connections.
- The settings on the FSSB screen are canceled when the power is turned off then back on.
- Action: After setting desired values, press soft key [SETTING] on the amplifier setting screen and axis setting screen.
- P/S alarm 5138 “AXIS SETTING NOT COMPLETE” is issued.
- Action: Automatic setting on the FSSB screen is not terminated normally. Make settings correctly on the FSSB amplifier setting screen and axis setting screen, and press soft key [SETTING] on both screens. At this time, be sure to make settings on the amplifier setting screen and the axis setting screen in this order.

Action: When automatic setting on the FSSB screen is not performed, set all of parameter Nos. 1902, 1905, 1910 through 1919, 1936, and 1937 to 0 before starting manual setting.

- The invalid amplifier/motor combination alarm (466) is issued.

Action: Check if the maximum current value of the amplifier read on the ID screen matches the setting of parameter No. 2165. Recheck the amplifier/motor combination.

Action: Initialize the servo parameters of each axis.



- When the power is turned off then back on after modifying parameter No. 1902, the system alarm (920) is issued.

Action: Disconnect the optical cable of the CNC, then turn off then on the power.

Set all of parameter Nos. 1902, 1905, 1910 through 1919, 1936, and 1937 to 0, then turn off then on the power, then make an FSSB setting all over again.

D.8 FSSB DATA DISPLAY

The FSSB setting screen displays FSSB-based amplifier and axis information, and allows amplifier and axis information to be set.

- 1 Press function key  .
- 2 Pressing the continuous menu key  several times displays [FSSB].
- 3 Pressing soft key [FSSB] switches the screen display to the amplifier setting screen (or the FSSB setting screen selected previously), and displays the following soft keys:

```
[ AMP ] [ AXIS ] [ MAINT ] [      ] [ (OPRT) ]
```

There are three types of FSSB setting screens: the amplifier setting screen, axis setting screen, and amplifier maintenance screen.

Pressing soft key [AMP] switches the screen display to the amplifier setting screen.

Pressing soft key [AXIS] switches the screen display to the axis setting screen. Pressing soft key [MAINT] switches the screen display to the amplifier maintenance screen.

D.8.1 Amplifier Setting Screen

The amplifier setting screen displays slave information divided into amplifier information and separate detector interface unit information.

```
(AMPLIFIER SETTING)      O1000 N00001
NO.
 1  A1-L      α      SVM-HV  40AL  1  X
 2  A1-M      α      SVM    12A  2  Y
 3  A2-L      β      SVM    40A  3  Z
 4  A3-L      α      SVM    20A  4  A
 5  A3-M      α      SVM    40A  5  B
 7  A4-L      α      SVU   240A  6  C

NO.      PCB ID
 6      M1      A      0000 DETECTOR (8AXES)
 8      M2      B      12AB

>_
MDI **** * 13:11:56
[ AMP ] [ AXIS ] [ MAINT ] [      ] [ (OPRT) ]
```

The amplifier setting screen displays the items below.

- NO.: Slave number
The serial numbers for up to ten slaves (up to eight amplifiers and up to two pulse modules) connected via the FSSB are displayed sequentially. A younger number is assigned to a slave closer to the CNC.
- AMP: Amplifier type
Amplifier type information starts with the character A, which stands for “amplifier.” The character A is followed by the ordinal number of an amplifier counted from the amplifier closest to the CNC, then is followed by a letter indicating which axis of the amplifier is used (L for the first axis, and M for the second axis).

- **AXIS NO:** Controlled axis number
The controlled axis numbers set in parameter Nos. 1920 through 1929 are displayed.
When a value outside the range 1 to the maximum number of controlled axes is set, 0 is displayed.
- **NAME:** Controlled axis name
The axis name set in the parameter No. 1020 corresponding to a controlled axis number is displayed. When the controlled axis number is 0, – is displayed.
- As amplifier information, the following information items are displayed:
 - **UNIT:** Type of servo amplifier unit
 - **SERIES:** Servo amplifier series
 - **CURRENT:** Maximum current value
- As separate detector interface unit information, the information items below are displayed.
 - **EXTRA**
The character M, which stands for “separate detector interface unit,” is followed by the ordinal number of a separate detector interface unit counted from the separate detector interface unit closest to the CNC.
 - **TYPE**
The type of a separate detector interface unit is displayed by a letter.
 - **PCB ID**
The ID of a separate detector interface unit is displayed using four digits in hexadecimal. For a separate detector module (8 axes), DETECTOR (8AXES) is displayed after the separate detector interface unit ID. For a separate detector module (4 axes), DETECTOR (4AXES) is displayed after the separate detector interface unit ID.

D.8.2 Axis Setting Screen

The axis setting screen displays axis information.

```

(Axis Setting)                               O1000 N00001
          M1 M2                               Cs
1      X  A1-L  0  0  0  0  1
2      Y  A1-M  1  0  1  0  0
3      Z  A2-L  0  0  0  1  0
4      A  A3-L  0  0  0  0  2
5      B  A3-M  0  0  0  0  0
6      C  A4-L  0  0  0  0  0



>_
MDI **** * 13:11:56
[ AMP ] [ AXIS ] [ MAINT ] [ (OPRT) ]

```

The axis setting screen displays the items below.

- **AXIS NO:** Controlled axis number
The NC controlled axis numbers are displayed sequentially.
- **NAME:** Controlled axis name
- **AMP:** Type of amplifier connected to each axis
- **M1:** Connector number for separate detector interface unit 1
The connector number for separate detector interface unit 1 set in parameter No. 1931 is displayed.
- **M2:** Connector number for separate detector interface unit 2
The connector number for separate detector interface unit 2 set in parameter No. 1932 is displayed.
- **1DSP**
The value set in bit 0 (1DSP) of parameter No. 1904 is displayed. The value 1 is displayed for an axis (leaning control axis, high-speed current loop axis, high-speed interface axis) that exclusively uses a DSP.
- **CS:** Cs contour control axis
The value set in parameter No. 1933 is displayed. The value 1 is displayed for a Cs contour control axis.
- **TANDEM (M series only)** (This item is disabled in Series 0i-B/0i Mate-B)
The value set in parameter No. 1934 is displayed. For a master axis and slave axis used for tandem control, an odd number and a subsequent even number are displayed.

D.8.3 Amplifier Maintenance Screen

The amplifier maintenance screen displays servo amplifier maintenance information. There are two types of amplifier maintenance screens as shown below. The user can switch between the two screens with the page keys  and .

| (AMPLIFIER SETTING) | | | | O1000 N00001 | | |
|------------------------------|---|------|----------|--------------|---|------|
| 1 | X | A1-L | α | SVM-HV | 2 | 40AL |
| 2 | Y | A1-M | α | SVM | 2 | 12A |
| 3 | Z | A2-L | β | SVM | 1 | 40A |
| 4 | A | A3-L | α | SVM | 2 | 20A |
| 5 | B | A3-M | α | SVM | 2 | 40A |
| 6 | C | A4-L | α | SVU | 1 | 240A |
| MDI **** * * * * * | | | | 13:11:56 | | |
| [AMP] [AXIS] [MAINT] [| | | |] [(OPRT)] | | |

```

(AMPLIFIER MAINTENANCE)          01000 N00001
                                  NO.
  1   X   01A   020123   01
  2   Y   01A   020123   01
  3   Z   01A   020123   01
  4   A   02B   020123   01
  5   B   02B   020123   01
  6   C   02B   020123   01

```

```

MDI **** * * * *          13:11:56
[ AMP ] [ AXIS ] [ MAINT ] [          ] [ (OPRT) ]

```

The amplifier maintenance screens display the following items:

- **AXIS NO:** Controlled axis number
- **NAME:** Controlled axis name
- **AMP:** Type of an amplifier connected to each axis
- **SERIES:** Series of a servo amplifier connected to each axis
- **UNIT:** Unit type of a servo amplifier connected to each axis
- **NO. OF AXES:** Maximum number of axes of an amplifier connected to each axis
- **CURRENT:** Maximum current value of an amplifier connected to each axis
- **VERSION:** Version of an amplifier unit connected to each axis
- **TEST:** Test date of an amplifier connected to each axis
Example) 010123: January 23, 2002
- **MAINTENANCE:** Engineering change drawing number of an amplifier connected to each axis





















E NOTATION OF MDI KEYS

















i series CNC have two types of MDI keypads : English type and Symbolic type.

The table below shows correspondence between English keys and Symbolic keys.

This manual uses English type in the text.

Therefore when a user uses Symbolic type MDI keypads and encounters an English key in the text, please refer to the correspondence table shown below.

| Name | English key | Symbolic key |
|------------------------|---|---|
| CANCEL key |  |  |
| POSITION key |  |  |
| PROGRAM key |  |  |
| OFFSET/ SETTING key |  |  |
| CUSTOM key |  |  |
| SYSTEM key |  |  |
| MESSAGE key |  |  |
| GRAPH key |  |  |
| SHIFT key |  |  |
| INPUT key |  |  |

| Name | English key | Symbolic key |
|------------------|---|---|
| ALTER key |  |  |
| INSERT key |  |  |
| DELETE key |  |  |
| PAGE UP key |  |  |
| PAGE DOWN key |  |  |
| HELP key |  |  |
| RESET key |  |  |
| CUSTOM/GRAPH key |  |  |

[Symbols]

[Sample Setting 1] General Configuration (Semi-Closed Loop), 635

[Sample Setting 2] General Configuration (Closed Loop), 636

[Sample Setting 3] When the C-Axis is a Cs Axis, 638

α i Servo Information Screen, 422

α i Servo Warning Interface, 420

α i Spindle Error State Messages, 442

α i Spindle Information Screen, 443

[A]

AC Spindle (Analog Interface), 447

AC Spindle (Serial Interface), 426, 427

Action Against Noise, 240

Actions for Trouble Encountered at Start-Up Time, 652

Address, 289

Adjusting Reference Position (DOG Method), 415

Alarm 300 (Request for Reference Position Return), 492

Alarm 401 (V Ready Off), 493

Alarm 404 (V Ready On), 495

Alarm 417 (Digital Servo System is Abnormal), 497

Alarm 462 (Send CNC Data Failed), 496

Alarm 463 (Send Slave Data Failed), 496

Alarm 5134 (FSSB: Open Ready Time Out), 504

Alarm 5135 (FSSB: Error Mode), 504

Alarm 5136 (FSSB: Number of Amps is Small), 506

Alarm 5137 (FSSB: Configuration Error), 504

Alarm 5197 (FSSB: Open Time Out), 504

Alarm 5198 (FSSB: ID Data Not Read), 504

Alarm 700 (Overheat: Control Unit), 498

Alarm 701 (Overheat: Fan Motor), 499

Alarm 704 (Spindle Speed Fluctuation Detection Alarm), 500

Alarm 749 (Serial Spindle Communication Error), 501

Alarm 750 (Spindle Serial Link Startup Failure), 502

Alarm 85 to 87 (Reader/Puncher Interface Alarm), 486

Alarm 90 (Reference Position Return is Abnormal), 490

Alarm 900 (ROM Parity), 507

Alarm 920 (Servo Alarms), 509

Alarm 926 (FSSB Alarm), 510

Alarm 930 (CPU Interrupt), 513

Alarm 935 (SRAM ECC Error), 514

Alarm 950 (PMC System Alarm), 515

Alarm 951 (PMC Watchdog Alarm), 518

Alarm 972 (NMI Alarm on an Option Board) (Series 0i-C Only), 519

Alarm 973 (NMI Alarm with an Unknown Cause), 520

Alarm 974 (F-BUS Error), 521

Alarm 975 (BUS Error), 522

Alarm 976 (Local BUS Error), 523

Alarm display, 31

Alarm History Screen, 31

Alarm List, 531

Alarm List (Serial Spindle), 594

Alarm screen, 332

Alarm screen (ALARM), 306

Alarms, 647

Alarms 912 to 919 (Dram Parity), 508

Amplifier Maintenance Screen, 656

Amplifier Setting Screen, 654

Associated Parameters, 419

Automatic Operation Cannot be Done, 470

Automatic Setting, 633

Automatic Setting of Standard Parameters, 438

Axis Setting Screen, 655

[B]

Basic Units, 200

Battery for Absolute Pulse Coder Built into the Motor (6VDC), 221

Battery for Separate Absolute Pulse Coders (6VDC), 220

Block diagram, 448

Boot System, 609

[C]

Cable Clamp and Shield Processing, 245

Calculation of S analog voltage and related parameters, 449

Clearing alarm history, 31

CNC State Display, 90

Color Setting, 125

Color Setting Screen (8.4" Color LCD), 123
 Configuration Display of Software, 27
 Configuration of PCBs, 28
 Confirming the Parameters Required for Data Output, 251
 Connecting the Ground Terminal of the Control Unit, 243
 Connector and Card Configurations of Printed Circuit Boards, 163
 Contents Displayed, 62
 Contrast Adjustment, 129
 Copy function (COPY), 316
 Corrective Action for Failures, 455
 Correspondence between operation mode and parameters on spindle tuning screen, 435
 COUNTER screen, 339
 Counter screen (COUNTER), 309
 Cycle Start LED Signal has Turned Off, 478

[D]

Data Input/Output on the All IO Screen, 260
 Data Input/Output Using a Memory Card, 275
 Data Sampling for Storage Type Waveform Diagnosis, 98
 DATA table screen, 343
 Data table screen (C. DATA), 312
 Deletion of External Operator Messages Record, 38
 Demounting a Card PCB , 209
 Demounting a DIMM Module, 212
 Digital Servo, 401
 Display and Operation, 1
 Display Method, 28, 59, 104
 Display method, 430
 Display of PMC Diagnosis Screen, 304
 Display of the PMC Diagnosis Screen, 331
 Displaying Diagnostic Page, 62
 Displaying Servo Tuning Screen, 412
 Distributed I/O Setting, 234
 Dogless Reference Position Setting, 418
 Dynamic Display of Sequence Program, 299
 Dynamic Display of Sequence Programs, 322

[E]

Environmental Requirements Outside the Control Unit, 239
 Error Codes (Serial Spindle), 606
 Error Messages and Required Actions, 627
 Execution Period of PMC, 293
 External Operator Messages Record, 38

[F]

FANUC Two-Byte Character Code Table, 150
 Fast Data Server Board (For old type basic unit), 187
 Fast Ethernet Board (For old type basic unit), 180
 Focas1/Ethernet Parameter Setting, 398
 FSSB Data Display, 654
 FSSB Start-Up Procedure/Materials, 630
 Function Keys and Soft Keys, 2

[G]

General, 415, 418
 General of Interface, 287
 Graphic of Wave Diagnosis Data, 96
 Graphic screen (M series), 25
 Graphic screen (T series), 24
 Ground, 242

[H]

Hardware, 156
 Hardware Configuration, 157
 Hardware Overview, 158
 Help Function, 59
 Help screen, 24

[I]

I/O, 203
 I/O Board for 0i, 199
 I/O link connection check screen, 337
 I/O Module Assignment Name List, 295
 ID Information Screen (α i Servo Information Screen/ α i Spindle Information Screen), 30
 In a Connector Panel I/O Unit, Data is Input to an Unexpected Address, 484

In a Connector Panel I/O Unit, No Data is Output to an Expansion Unit, 485

Initial Setting Servo Parameters, 402

Input and Output of Data, 248

Input from and Output to I/O Devices Cannot be Performed Input/Output Cannot be Performed Properly, 482

Input of PMC parameter from MDI, 308

Input/output method, 315, 349

Input/Output of PMC Data, 315

Inputting and Outputting Floppy Files, 270

Inputting and Outputting Offset Data, 268

Inputting and Outputting Parameters, 267

Inputting and Outputting Programs, 263

Inputting and Outputting the Operation History Data, 53

Inputting CNC Parameters, 255

Inputting Custom Macro Variable Values, 257

Inputting Part Programs, 258

Inputting pitch error compensation amount, 257

Inputting PMC Parameters, 256

Inputting Tool Compensation Amount, 258

Inputting/Outputting Data, 251

Interface between CNC and PMC, 286

Inverter PCBs, 178

Investigating the Conditions Under which Failure Occurred, 455

[J]

Jog Operation Cannot be Done, 461

[K]

KEEP RELAY screen, 340

Keep relay screen (KEEPRL), 309

[L]

Ladder diagram display screen, 323

Ladder diagram editing screen, 326

LCD/MDI Units, 200

List of Addresses, 371

List of Alarm Codes (CNC), 532

List of Alarms (PMC), 569

List of Input/Output Signals, 356

List of Maintenance Parts, 608

List of Operations, 106

List of Signals by Each Mode, 354

Load Basic System Function, 625

[M]

Main Board, 163

Maintenance Information Input/Output, 122

Maintenance Information Screen, 119

Manual Handle Operation Cannot be Done, 465

Manual Setting 1, 646

Manual Setting 2, 640

Memory Card File Delete Screen, 623

Memory Card Format Function, 624

Message screen, 23

Method A of gear change for machining center (PRM 3705#2=0), 429

Method B of gear change for machining center (PRM 3705#2=1), 429

Module Configuration Screen, 30

Mounting a Card PCB, 210

Mounting a DIMM Module, 212

Mounting and Demounting Card PCBs, 208

Mounting and Demounting DIMM Modules, 211

[N]

Net editing screen, 328

No Manual Operation Nor Automatic Operation Can be Executed, 457

Noise Suppressor, 244

Notation of MDI Keys, 658

Notes, 39, 58, 103, 128, 139

Nothing is Displayed on the LCD when the Power is Turned On, 480

[O]

Offset/setting screen (M series), 15

Offset/setting screen (T series), 13

Online Monitor Setting Screen, 318, 352

Operating Monitor, 104

Operation, 418

Operation History, 40

Other Units, 203
 Outline of Spindle Control, 427, 447
 Outputting CNC Parameters, 252
 Outputting Custom Macro Common Variables, 269
 Outputting Custom Macro Variable Values, 254
 Outputting Part Program, 254
 Outputting Pitch Error Compensation Amount, 253
 Outputting PMC Parameters, 253
 Outputting Tool Compensation Amount, 254
 Outputting Waveform Diagnosis Data (Storage Type), 100
 Overview, 140









[P]

Parameter, 37, 39, 130
 Parameter Input/Output, 137
 Parameter input/output method, 337
 Parameter Setting, 40, 412
 Parameters, 105, 127
 Periodic Maintenance Screens, 140
 PMC Data Input/Output, 348
 PMC Menu Selection Procedure Using Soft Keys, 298, 321
 PMC Parameter, 308
 PMC Parameters, 337
 PMC Screen (PMC-SA1), 298
 PMC Screen (PMC-SB7), 321
 Position screen, 3
 Power Mate CNC Manager, 130
 Printed Circuit Boards, 201
 PROFIBUS-DP Board, 193
 Program screen, 4, 6, 8, 9, 10, 11

[R]

Registered Data Input/Output, 148
 Replacing Battery, 215
 Replacing Fan Motors, 222
 Replacing Fuse on Control Unit, 213
 Replacing Fuses on Various Units, 236
 Replacing LCD Backlight, 225
 Replacing the Main Board, 204

[S]

Screen Configuration and Operating Procedure, 612
 Screen Display, 38, 45, 125, 131
 Screen display, 31
 Screen Display and Operation, 119
 Screen Display and Setting, 140
 Screen Displayed Immediately After Power is Turned On, 26
 Selection monitor screen, 325
 Separating Signal Lines, 240
 Servo Alarms, 524
 Servo Tuning Screen, 412
 Setting Input/Output-Related Parameters, 261
 Setting Module Screen, 27
 Setting Parameters, 92
 Setting Parameters for Input/Output, 249
 Setting screen, 314
 Setting Screen Display and Setting, 146
 Setting screens, 345
 Setting the Input Signal or Output Signal to be Recorded in the Operation History, 49
 Slave, 632
 Slot Status Display, 26
 Soft key transition triggered by the function key , 24, 25
 Soft key transition triggered by the function key , 24
 Soft key transition triggered by the function key , 23
 Soft key transition triggered by the function key , 13, 15
 Soft key transition triggered by the function key , 3
 Soft key transition triggered by the function key  (When the soft key [BG-EDT] is pressed in all modes), 11
 Soft key transition triggered by the function key  in the EDIT mode, 6
 Soft key transition triggered by the function key  in the HNDL, JOG, or REF mode, 9
 Soft key transition triggered by the function key  in the MDI mode, 8

Soft key transition triggered by the function key



in the MEM mode, 4

Soft key transition triggered by the function key



in the TJOG or THDL mode, 10

Soft key transition triggered by the function key



, 17

Soft Keys, 2

Software Configuration Screen, 29

SPC Alarms, 527

Specification, 288

Specification of PMC, 288

Spindle Alarms, 528

Spindle monitor screen, 433

Spindle Setting and Tuning Screen, 430

Spindle setting screen, 430

Spindle tuning screen, 431

SRAM Data Backup Screen, 620

Start of the built-in type PMC programmer, 315

Starting the Boot System, 610

Starting the built-in programmer, 348

Status screen, 332

Status screen (STATUS), 305

Status Screen Display and Setting, 141

System Alarm History, 32

System alarm history screen (detail screen), 34

System alarm history screen (history list screen), 32

System Configuration Screen, 28

System Data Check Screen, 615

System Data Delete Screen, 617

System Data Loading Screen, 613

System Data Save Screen, 618

System Files and User Files, 611

System Parameters, 317, 350

System Reserve Area of Internal Relay, 290

System screen, 17

[T]

T series, 429

TIMER screen, 338

Timer screen (TIMER), 308

Title screen, 331

Title screen (TITLE), 304

Total Connection Diagrams, 160

Trace function, 333

Trace screen (TRACE), 306

Troubleshooting, 453

Tuning S analog voltage (D/A converter), 451

[U]

Units and Printed Circuit Boards, 200

[W]

Warning Interface for the α i Spindle, 440

Warning Screen Displayed when an Option is Changed, 116

Warning Screen Displayed when System Software is Replaced (System Label Check Error), 118

Waveform Diagnostic Function, 92

Waveform Diagnostic Parameter Screen, 93

Symbols

[Sample Setting 1] General Configuration (Semi-Closed Loop), 633

[Sample Setting 2] General Configuration (Closed Loop), 634

[Sample Setting 3] When the C-Axis is a Cs Axis, 636

α i Servo Information Screen, 421

α i Servo Warning Interface, 419

α i Spindle Error State Messages, 440

α i Spindle Information Screen, 441

[A]

AC Spindle (Analog Interface), 445

AC Spindle (Serial Interface), 425, 426

Action Against Noise, 239

Actions for Trouble Encountered at Start-Up Time, 650

Address, 288

Adjusting Reference Position (DOG Method), 414

Alarm 300 (Request for Reference Position Return), 490

Alarm 401 (V Ready Off), 491

Alarm 404 (V Ready On), 493

Alarm 417 (Digital Servo System is Abnormal), 495

Alarm 462 (Send CNC Data Failed), 494

Alarm 463 (Send Slave Data Failed), 494

Alarm 5134 (FSSB: Open Ready Time Out), 502

Alarm 5135 (FSSB: Error Mode), 502

Alarm 5136 (FSSB: Number of Amps is Small), 504

Alarm 5137 (FSSB: Configuration Error), 502

Alarm 5197 (FSSB: Open Time Out), 502

Alarm 5198 (FSSB: ID Data Not Read), 502

Alarm 700 (Overheat: Control Unit), 496

Alarm 701 (Overheat: Fan Motor), 497

Alarm 704 (Spindle Speed Fluctuation Detection Alarm), 498

Alarm 749 (Serial Spindle Communication Error), 499

Alarm 750 (Spindle Serial Link Startup Failure), 500

Alarm 85 to 87 (Reader/Puncher Interface Alarm), 484

Alarm 90 (Reference Position Return is Abnormal), 488

Alarm 900 (ROM Parity), 505

Alarm 920 (Servo Alarms), 507

Alarm 926 (FSSB Alarm), 508

Alarm 930 (CPU Interrupt), 511

Alarm 935 (SRAM ECC Error), 512

Alarm 950 (PMC System Alarm), 513

Alarm 951 (PMC Watchdog Alarm), 516

Alarm 972 (NMI Alarm on an Option Board) (Series 0@i-C Only), 517

Alarm 973 (NMI Alarm with an Unknown Cause), 518

Alarm 974 (F-BUS Error), 519

Alarm 975 (BUS Error), 520

Alarm 976 (Local BUS Error), 521

Alarm display, 31

Alarm History Screen, 31

Alarm List, 529

Alarm List (Serial Spindle), 592

Alarm screen, 331

Alarm screen (ALARM), 305

Alarms, 645

Alarms 912 to 919 (Dram Parity), 506

Amplifier Maintenance Screen, 654

Amplifier Setting Screen, 652

Associated Parameters, 418

Automatic Operation Cannot be Done, 468

Automatic Setting, 631

Automatic Setting of Standard Parameters, 437

Axis Setting Screen, 653

[B]

Basic Units, 198

Battery for Absolute Pulse Coder Built into the Motor (6VDC), 220

Battery for Separate Absolute Pulse Coders (6VDC), 219

Block diagram, 446

Boot System, 607

[C]

Cable Clamp and Shield Processing, 244

Calculation of S analog voltage and related parameters, 447

Clearing alarm history, 31

CNC State Display, 90

Color Setting, 125

Color Setting Screen (8.4@” Color LCD), 123
 Configuration Display of Software, 27
 Configuration of PCBs, 28
 Confirming the Parameters Required for Data Output, 250
 Connecting the Ground Terminal of the Control Unit, 242
 Connector and Card Configurations of Printed Circuit Boards, 163
 Contents Displayed, 62
 Contrast Adjustment, 129
 Copy function (COPY), 315
 Corrective Action for Failures, 453
 Correspondence between operation mode and parameters on spindle tuning screen, 434
 COUNTER screen, 338
 Counter screen (COUNTER), 308
 Cycle Start LED Signal has Turned Off, 476

[D]

Data Input/Output on the All IO Screen, 259
 Data Input/Output Using a Memory Card, 274
 Data Sampling for Storage Type Waveform Diagnosis, 98
 DATA table screen, 342
 Data table screen (DATA), 311
 Deletion of External Operator Messages Record, 38
 Demounting a Card PCB , 207
 Demounting a DIMM Module, 210
 Digital Servo, 400
 Display and Operation, 1
 Display Method, 28, 59, 104
 Display method, 429
 Display of PMC Diagnosis Screen, 303
 Display of the PMC Diagnosis Screen, 330
 Displaying Diagnostic Page, 62
 Displaying Servo Tuning Screen, 411
 Distributed I/O Setting, 233
 Dogless Reference Position Setting, 417
 Dynamic Display of Sequence Program, 298
 Dynamic Display of Sequence Programs, 321

[E]

Environmental Requirements Outside the Control Unit, 238
 Error Codes (Serial Spindle), 604
 Error Messages and Required Actions, 625
 Execution Period of PMC, 292
 External Operator Messages Record, 38

[F]

FANUC Two-Byte Character Code Table, 150
 Fast Data Server Board (For old type basic unit), 187
 Fast Ethernet Board (For old type basic unit), 180
 Focas1/Ethernet Parameter Setting, 397
 FSSB Data Display, 652
 FSSB Start-Up Procedure/Materials, 628
 Function Keys and Soft Keys, 2

[G]

General, 414, 417
 General of Interface, 286
 Graphic of Wave Diagnosis Data, 96
 Graphic screen (M series), 25
 Graphic screen (T series), 24
 Ground, 241

[H]

Handle Operation Cannot be Done, 463
 Hardware, 156
 Hardware Configuration, 157
 Hardware Overview, 158
 Help Function, 59
 Help screen, 24

[I]

I/O, 201
 I/O Board for 0@i, 197
 I/O link connection check screen, 336
 I/O Module Assignment Name List, 294
 ID Information Screen (@a@i Servo Information Screen/@a@i Spindle Information Screen), 30
 In a Connector Panel I/O Unit, Data is Input to an Unexpected Address, 482

In a Connector Panel I/O Unit, No Data is Output to an Expansion Unit, 483

Initial Setting Servo Parameters, 401

Input and Output of Data, 247

Input from and Output to I/O Devices Cannot be Performed Input/Output Cannot be Performed Properly, 480

Input of PMC parameter from MDI, 307

Input/output method, 314, 348

Input/Output of PMC Data, 314

Inputting and Outputting Floppy Files, 269

Inputting and Outputting Offset Data, 267

Inputting and Outputting Parameters, 266

Inputting and Outputting Programs, 262

Inputting and Outputting the Operation History Data, 53

Inputting CNC Parameters, 254

Inputting Custom Macro Variable Values, 256

Inputting Part Programs, 257

Inputting pitch error compensation amount, 256

Inputting PMC Parameters, 255

Inputting Tool Compensation Amount, 257

Inputting/Outputting Data, 250

Interface between CNC and PMC, 285

Inverter PCBs and Connector Units, 178

Investigating the Conditions Under which Failure Occurred, 453

[J]

Jog Operation Cannot be Done, 459

[K]

KEEP RELAY screen, 339

Keep relay screen (KEEPRL), 308

[L]

Ladder diagram display screen, 322

Ladder diagram editing screen, 325

LCD/MDI Units, 198

List of Addresses, 370

List of Alarm Codes (CNC), 530

List of Alarms (PMC), 567

List of Input/Output Signals, 355

List of Maintenance Parts, 606

List of Operations, 106

List of Signals by Each Mode, 353

Load Basic System Function, 623

M

Main Board, 163

Maintenance Information Input/Output, 122

Maintenance Information Screen, 119

Manual Setting 1, 644

Manual Setting 2, 638

Memory Card File Delete Screen, 621

Memory Card Format Function, 622

Message screen, 23

Method A of gear change for machining center, 428

Method B of gear change for machining center (PRM 3705#2=1), 428

Module Configuration Screen, 30

Mounting a Card PCB, 208

Mounting a DIMM Module, 210

Mounting and Demounting Card PCBS, 206

Mounting and Demounting DIMM Modules, 209

N

Net editing screen, 327

No Manual Operation Nor Automatic Operation Can be Executed, 455

Noise Suppressor, 243

Notation of MDI Keys, 656

Notes, 39, 58, 103, 128, 139

Nothing is Displayed on the LCD when the Power is Turned On, 478

O

Offset/setting screen (M series), 15

Offset/setting screen (T series), 13

Online Monitor Setting Screen, 317, 351

Operating Monitor, 104

Operation, 417

Operation History, 40

Other Units, 201

Outline of Spindle Control, 426, 445

Outputting CNC Parameters, 251
 Outputting Custom Macro Common Variables, 268
 Outputting Custom Macro Variable Values, 253
 Outputting Part Program, 253
 Outputting Pitch Error Compensation Amount, 252
 Outputting PMC Parameters, 252
 Outputting Tool Compensation Amount, 253
 Outputting Waveform Diagnosis Data (Storage Type),
 100
 Overview, 140

P

Parameter, 37, 39, 130
 Parameter Input/Output, 137
 Parameter input/output method, 336
 Parameter Setting, 40, 411
 Parameters, 105, 127
 Periodic Maintenance Screens, 140
 PMC Data Input/Output, 347
 PMC Menu Selection Procedure Using Soft Keys,
 297, 320
 PMC Parameter, 307
 PMC Parameters, 336
 PMC Screen (PMC-SA1), 297
 PMC Screen (PMC-SB7), 320
 Position screen, 3
 Power Mate CNC Manager, 130
 Printed Circuit Boards, 199
 PROFIBUS-DP Board, 193
 Program screen, 4, 6, 8, 9, 10, 11

R

Registered Data Input/Output, 148
 Replacing Battery, 214
 Replacing Fan Motors, 221
 Replacing Fuse on Control Unit, 211
 Replacing Fuses on Various Units, 235
 Replacing LCD Backlight, 224
 Replacing the Main Board, 202

S

Screen Configuration and Operating Procedure, 610
 Screen Display, 38, 45, 125, 131
 Screen display, 31
 Screen Display and Operation, 119
 Screen Display and Setting, 140
 Screen Displayed Immediately After Power is Turned
 On, 26
 Selection monitor screen, 324
 Separating Signal Lines, 239
 Servo Alarms, 522
 Servo Tuning Screen, 411
 Setting Input/Output-Related Parameters, 260
 Setting Module Screen, 27
 Setting Parameters, 92
 Setting Parameters for Input/Output, 248
 Setting screen, 313
 Setting Screen Display and Setting, 146
 Setting screens, 344
 Setting the Input Signal or Output Signal to be
 Recorded in the Operation History, 49
 Slave, 630
 Slot Status Display, 26
 Soft key transition triggered by the function key
 <GRAPH>, 24, 25
 Soft key transition triggered by the function key
 <HELP>, 24
 Soft key transition triggered by the function key
 <MESSAGE>, 23
 Soft key transition triggered by the function key
 <OFFSET/SETTING>, 13, 15
 Soft key transition triggered by the function key
 <POS>, 3
 Soft key transition triggered by the function key
 <PROG> (When the soft key [BG-EDT] is pressed
 in all modes), 11
 Soft key transition triggered by the function key
 <PROG> in the EDIT mode, 6
 Soft key transition triggered by the function key
 <PROG> in the HNDL, JOG, or REF mode, 9
 Soft key transition triggered by the function key
 <PROG> in the MDI mode, 8
 Soft key transition triggered by the function key
 <PROG> in the MEM mode, 4
 Soft key transition triggered by the function key
 <PROG> in the TJOG or THDL mode, 10
 Soft key transition triggered by the function key
 <SYSTEM>, 17
 Soft Keys, 2

Software Configuration Screen, 29
 SPC Alarms, 525
 Specification, 287
 Specification of PMC, 287
 Spindle Alarms, 526
 Spindle monitor screen, 432
 Spindle Setting and Tuning Screen, 429
 Spindle setting screen, 429
 Spindle tuning screen, 430
 SRAM Data Backup Screen, 618
 Start of the built-in type PMC programmer, 314
 Starting the Boot System, 608
 Starting the built-in programmer, 347
 Status screen, 331
 Status screen (STATUS), 304
 Status Screen Display and Setting, 141
 System Alarm History, 32
 System alarm history screen (detail screen), 34
 System alarm history screen (history list screen), 32
 System Configuration Screen, 28
 System Data Check Screen, 613
 System Data Delete Screen, 615
 System Data Loading Screen, 611
 System Data Save Screen, 616
 System Files and User Files, 609
 System Parameters, 316, 349
 System Reserve Area of Internal Relay, 289
 System screen, 17

T

T series, 428
 TIMER screen, 337
 Timer screen (TIMER), 307
 Title screen, 330
 Title screen (TITLE), 303
 Total Connection Diagrams, 160
 Trace function, 332
 Trace screen (TRACE), 305
 Troubleshooting, 451
 Tuning S analog voltage (D/A converter), 449

U

Units and Printed Circuit Boards, 198

W

Warning Interface for the @a@i Spindle, 438
 Warning Screen Displayed when an Option is Changed, 116
 Warning Screen Displayed when System Software is Replaced (System Label Check Error), 118
 Waveform Diagnostic Function, 92
 Waveform Diagnostic Parameter Screen, 93

Revision Record

FANUC Series 0i-MODEL C/0i Mate-MODEL C MAINTENANCE MANUAL (B-64115EN)

| Edition | Date | Contents | Edition | Date | Contents |
|---------|------------|---|---------|------|----------|
| 02 | Mar., 2006 | <ul style="list-style-type: none"> ● Adaptation to changes of the basic unit ● Addition of the 10.4" LCD display unit ● Addition of the touch panel display unit ● Correction of errors | | | |
| 01 | Jun., 2004 | _____ | | | |
| | | | | | |

